

Sistema per serramenti
scorrevoli e alzanti
a taglio termico

TOP SLIDE **160 plus**

alsistem.com

Sistemi a design minimale



3C
SYSTEM-RESOLUTION

3C UP
SYSTEM-RESOLUTION

Sistema per serramenti a taglio termico con tripla guarnizione dal design minimale, con nodo laterale di 75mm

System for thermal break windows with triple gasket with minimal design, with 75mm lateral section



ECO-SLIM
72 - 62 - 50
72 - 62 UP

Sistema per serramenti a taglio termico dal design minimale, con nodo laterale di 75mm

System for thermal break windows with a minimal design, with 75mm lateral section



panoramico

Sistema scorrevole dalla mostra architettonica ridotta al minimo e in cui l'alluminio lascia spazio ad ampie specchiature

Minimal design sliding system where aluminium lets glass take the leading role

Sistemi non isolati



PLANET 45

Sistema per serramenti non isolati ad elevata ermeticità

Weatherproof European chamber non-insulated window and door systems

Sistemi a battente



PLANET
72 - 62 - 50 PLUS
72 - 62 UP

Sistema a taglio termico per serramenti con eccellenti valori termici, acustici e fisico meccanici

Planet top-range thermal break system with excellent thermal- and acoustic-proofness and physical-mechanical properties



MATIC
72 - 62 - 50 PLUS
72 - 62 UP

Sistemi a taglio termico per serramenti con ferramenta perimetrale ed elevate prestazioni termiche ed acustiche

Thermal break systems with perimeter hardware for high-performance thermal and acoustic-proof windows and doors

Sistemi scorrevoli e alzanti



SLIDE 60

Sistema scorrevole non isolato, essenziale e funzionale, con zanzariera integrata nel sistema

Non-insulated system, essential and functional. With built-in screen



SLIDE 65

Sistema scorrevole a taglio termico essenziale e funzionale con zanzariera prevista e integrata al sistema

Thermal break system, essential and functional, with built-in screen



SLIDE 80/106 PLUS

Sistema scorrevole-alzante a taglio termico rivoluzionario grazie agli eccellenti risultati termici ed acustici

Revolutionary thermal break system providing excellent thermal and acoustic performance



TOP SLIDE 160 PLUS
160 UP

Sistema a taglio termico per serramenti alzanti con portate fino a 400kg, ed eccellenti prestazioni acustiche, termiche e ambientali

Thermal break system for lift-and-slide windows of up to 400kg providing excellent acoustic, thermal and environmental performance

INDICE GENERALE INDEX

Descrizione tecnica capitolato <i>Specifications</i>	04
Curve limite di utilizzo <i>Limit curves</i>	22
Tipologie costruttive <i>Construction types</i>	23
Elenco profili <i>List of profiles</i>	24
Sagomario <i>Profile representation</i>	33
Vetrazione <i>Glazing</i>	50
Indice alfanumerico accessori / guarnizioni <i>Alphanumeric index</i>	54
Accessori - guarnizioni, generici, giunzioni, chiusure <i>Accessories - Gaskets, general items, joints, closures</i>	60
Distinte taglio <i>Cutting lists</i>	71
Nodi e sezioni <i>Sections</i>	82
Attrezzature <i>Equipment</i>	117
Lavorazioni / Montaggi <i>Working / Assembly</i>	119

Traccia per capitolato

Infissi alzanti scorrere in alluminio realizzati con la gamma per serramenti a taglio termico Top Slide 160 Plus. I profilati sono estrusi in lega di alluminio EN AW-6060 (UNI EN 573-3), stato di fornitura T5 e T6 conformi alla norma UNI EN 515 con tolleranze dimensionali e di spessore conformi alla norma UNI EN 12020-2. L'isolamento termico è costituito da barrette a doppio tubolare da 28mm, il telaio fisso dovrà presentarsi tassativamente con doppio taglio termico, ovvero uno ogni binario; il materiale dovrà essere poliammide 6.6 rinforzato al 25% con fibre di vetro; l'assemblaggio delle barrette avverrà a mezzo di rullatura meccanica computerizzata, e le caratteristiche meccaniche delle barrette dovranno rimanere inalterate sino ad una temperatura massima di trattamento di 245°C.

Il processo di produzione è controllato secondo le norme UAETC, i valori di scorrimento dovranno essere superiori ai 24 daN/mm. Il telaio fisso avrà profondità 160mm mentre le parti apribili avranno una profondità di 72mm. Il sistema di tenuta sarà con guarnizioni in espanso rivestito. La soglia dovrà essere tassativamente non superiore ai 25mm ed il binario sul quale scorreranno i carrelli dovrà essere esclusivamente in acciaio inox AISI 316. La sigillatura dei vetri dovrà avvenire secondo le indicazioni riportate nel catalogo e solo ed esclusivamente con guarnizioni fermavetro originali. Appositi fori di drenaggio dovranno essere previsti sul telaio fisso e su quello mobile al fine di permettere il corretto drenaggio del serramento. La scelta dei profili sarà in funzione delle caratteristiche geometriche e dimensionali dell'infisso, della portata degli accessori e dei carichi di esercizio. Gli accessori utilizzati nella fabbricazione delle diverse tipologie dovranno essere solo ed esclusivamente quelli originali studiati appositamente per il sistema, riportati a catalogo e distribuiti dai licenziatari ALSistem, l'utilizzo di prodotti diversi da quelli indicati oppure il montaggio parziale o scorretto degli stessi comporterà la nullità dei certificati di prova e garanzia. La fabbricazione e la posa dovranno avvenire secondo i criteri di lavoro indicati da ALSistem. L'assemblaggio dei profili avverrà con squadrette in alluminio pressofuso multifunzione, i tagli dovranno essere protetti a mezzo sigillanti acrilici, siliconici neutri o polimeri MS.

La protezione e finitura dei profilati avverrà a mezzo dei normali trattamenti di superficie, ossidazione anodica conforme al marchio di qualità "Qualanod" oppure a mezzo di verniciatura con polveri poliesteri termoidurenti e polimerizzate in forno a temperature comprese tra 185°C e 195°C, in conformità del marchio di qualità "Qualicoat". La posa dovrà avvenire secondo i criteri disciplinati nel protocollo Thermoposa.

Materiali

L'esecuzione dei serramenti è in lega d'alluminio EN AW-6060 sotto forma di profilati estrusi come indicato dalla disposizione normativa UNI EN 573-3. Lo stato di fornitura è in classe T5 e T6 secondo norma UNI EN 515. Le tolleranze dimensionali sono conformi alla UNI EN 12020-2. Lega secondo la formula ALSistem.

Caratteristiche tecniche e dimensionali

Profilati: estrusi in lega leggera EN AW-6060 (UNI EN 573-3) anodizzabili e verniciabili. Lega secondo la formula ALSistem

Sistema di tenuta: con guarnizioni in materiale espanso rivestito

Sistema di isolamento termico telai: realizzato con due file di distanziali in poliammide da 28mm a forma tubolare

Sistema di isolamento termico ante: realizzato con distanziali in poliammide da 28mm a forma tubolare

Sistema di accessori: alzante scorrere di ottima qualità

Altezza battuta vetro: 22mm

Profondità telaio: 160mm

Profondità anta: 72mm

Fissaggio vetri: con fermavetri

Spazio vetro o pannello: da 13mm fino a 63mm

Protezione superficiale

La protezione dei profilati potrà essere effettuata mediante ossidazione anodica con classe di spessore >15 micron, come da norma UNI 10681, oppure mediante verniciatura a polveri poliesteri termoidurenti e polimerizzate in forno nel rispetto delle procedure di qualità "Qualicoat" e delle disposizioni UNI EN 12206-1.

Resistenza della finitura

La finitura superficiale non deve subire corrosioni o alterazioni di aspetto per un periodo di tempo adeguato alla vita del manufatto.

Le caratteristiche sufficienti per assicurarne il comportamento in funzione del tipo di ambiente sono specificate dalle norme UNI 10681 per l'ossidazione e UNI EN 12206-1 per la verniciatura, ricordando che i principali fattori che influiscono sulla resistenza all'ambiente sono la vicinanza al mare, l'inquinamento atmosferico, la manutenzione e la pulizia anche dalla pioggia.

Sicurezza

Al fine di non causare danni fisici o lesioni agli utenti, i serramenti devono essere concepiti secondo le prescrizioni della normativa in materia di sicurezza D.Lgs. 81/2008 e UNI 7697 ed utilizzare secondo quanto indicato nel nostro “manuale uso e manutenzione” dei serramenti e schermi oscuranti.

Caratteristiche della vetrazione

La scelta della vetrazione deve essere effettuata secondo criteri prestazionali per rispondere ai requisiti di risparmio energetico, isolamento acustico, controllo della radiazione solare, sicurezza. Riferimento norme: UNI EN ISO 10140-2, UNI EN 12488, UNI EN 572-1, UNI EN 12758, UNI EN 12150-1, UNI 11463 DM 2 Aprile 1998, Legge 90/2013 e DMSE 26/06/2015 (requisiti minimi).

Guarnizioni

Le guarnizioni dovranno essere esclusivamente quelle originali studiate per il sistema, a garanzia delle prestazioni dello stesso e rispondenti alle norme di riferimento UNI 3952, UNI EN 12365-1/4.

Sigillanti

I sigillanti devono corrispondere a quanto prescritto dalle norme di riferimento UNI EN ISO 11600. Tali materiali non devono corrodere le parti in alluminio e sue leghe con cui vengono a contatto, pertanto dovranno essere neutri.

Accessori

Gli accessori dovranno essere quelli originali prodotti per la serie e rispondenti ai criteri indicati nelle norme UNI EN 13126-1/19 e alle disposizioni normative in materia di sicurezza DL 81/2008.

Prestazioni

La serie Top Slide 160 Plus risponde ai requisiti della norma UNI EN 12207, UNI EN 12208, UNI EN 12210.

Resistenza meccanica

Il sistema e gli accessori saranno resistenti alle sollecitazioni d'uso secondo i limiti stabiliti dalle norme UNI EN 12365-1 e UNI EN 13126-1/19.

Isolamento acustico

La scelta della classe di isolamento acustico di un serramento va correlata alla destinazione d'uso del locale nel quale l'infisso dovrà essere inserito ed al livello del rumore esterno; il comportamento del serramento in opera è influenzato da fattori che non è possibile definire a priori (h dal suolo, orientamento delle sorgenti sonore, ecc...). Il potere fonoisolante potrà essere quindi stimato con buona approssimazione, in base alla permeabilità all'aria del serramento con un minimo di valore di permeabilità pari a 2, ed al potere fonoisolante del vetro. Secondo la metodologia descritta nella norma di riferimento UNI EN ISO 10140-2.

Isolamento termico

La scelta delle prestazioni di isolamento termico deve essere operata in base alle esigenze di risparmio energetico secondo la Legge 10/91, il DL 192/05 e aggiornamento DL 311/06 ed alle esigenze di benessere ambientale o riferimento alla norma UNI EN ISO 10077-1. Si può calcolare la trasmittanza termica del serramento a partire dai valori di trasmittanza dei profili e delle superfici secondo norma UNI EN ISO 10077-1 con la formula:

$$U_w = (A_g \cdot U_g + A_f \cdot U_f + I_g \cdot \psi) \div (A_g + A_f)$$

Certificazioni

Sarà possibile richiedere al costruttore dei serramenti o, in mancanza, al produttore dei profilati, fotocopia dei rapporti di prova relative a determinate prestazioni.

Marcatura CE UNI EN 14351-1

La marcatura CE è OBBLIGATORIA e costituisce il sistema al quale tutti i Costruttori di serramenti devono uniformarsi per poter vendere i propri prodotti nell'Unione Europea. Spetta al Costruttore, o al suo rappresentante, con sede nella EEA [Area Economica Europea] la responsabilità di apporre la marcatura CE sul prodotto, su un'etichetta applicata al prodotto, sul suo imballaggio o sui documenti commerciali di accompagnamento. La norma UNI EN 14351-1 si applica alle finestre, porte finestre, alle porte pedonali esterne, alle porte esterne sulle vie di fuga, alle finestre da tetto/lucernari (incluse quelle resistenti al fuoco proveniente dall'esterno), alle finestre a nastro, alle finestre accoppiate e alle finestre doppie. Tali serramenti possono essere a una o più ante, con ante mobili e parti fisse, con apertura verso l'interno o verso l'esterno, a movimentazione manuale oppure automatizzata, interamente oppure parzialmente vetrati, con o senza telaio di contenimento della vetratura, con o senza dispositivi di schermatura incorporati.

La norma UNI EN 14351-1 non è applicabile a:

- finestre, portefinestre e porte pedonali con caratteristiche di resistenza al fuoco e tenuta al fumo
- alle porte interne (EN 14351-2)
- alle chiusure oscuranti esterne (UNI EN 13659)
- alle porte girevoli
- alle finestre poste sulle vie di fuga

La norma contempla determinati requisiti volontari e/o obbligatori:

- Tenuta all'acqua
- Rilascio di sostanze pericolose
- Resistenza all'urto
- Resistenza al vento
- Capacità portante dei dispositivi di sicurezza
- Isolamento acustico
- Isolamento termico
- Proprietà radianti delle vetrazioni (trasmissione Luminosa)
- Permeabilità all'aria

Piano di Controllo di Produzione (FPC)

Il controllo di produzione in fabbrica è un sistema esercitato dal costruttore sotto propria responsabilità, al fine di assicurare che le caratteristiche costruttive del prodotto siano mantenute nel tempo entro certi limiti. Il costruttore dovrà stabilire delle procedure documentate, che indichino le modalità che, il personale addetto ai vari controlli, dovrà effettuare per monitorare con frequenza ed esattezza il processo assegnatogli. Il costruttore è tenuto a garantire la rintracciabilità del prodotto attraverso l'uso di codici o altro. Mediante uno schema, il produttore è inoltre tenuto a comunicare al committente indicazioni circa l'utilizzo, la movimentazione, l'installazione, la manutenzione e pulizia del prodotto. Non sono invece analizzate le caratteristiche dell'installazione, ma suggeriamo caldamente di fare riferimento alle indicazioni riportate sui nostri manuali di posa "Thermoposa".

Test di Laboratorio (ITT)

Le caratteristiche del serramento sono valutate sul prodotto finito completo di ferramenta, vetrocamera, pannelli e di tutti gli accessori e trattamenti che lo rendono pronto all'uso. Il costruttore che lo richiama può ottenere i risultati delle prove (ITT) sui serramenti direttamente dall'ALSistem oppure dal licenziatario di zona, la quale cede il diritto d'uso dei risultati degli attestati dei propri ITT ricevuti dal Laboratorio, tramite un contratto fra le parti a "Cascading" (Cascata). Il costruttore ha la responsabilità della conformità del prodotto alle norme europee indicate sul progetto di norma e recepite dalle norme nazionali (norme UNI).

Posa in opera

E' molto importante, per ottenere un buon funzionamento del serramento, curare scrupolosamente la verticalità e il livellamento dell'infisso, dopodiché eseguire la sigillatura usando nastri autoespandenti Thermoposa seguendo i consigli dell'esempio sotto riportato, Controllare inoltre che le aperture siano caricate sufficientemente (spessorando il vetro di 1-2 mm fuori quadro), affinché, con l'assestamento dei materiali, non si verificino delle intolleranze di funzionamento nel tempo.

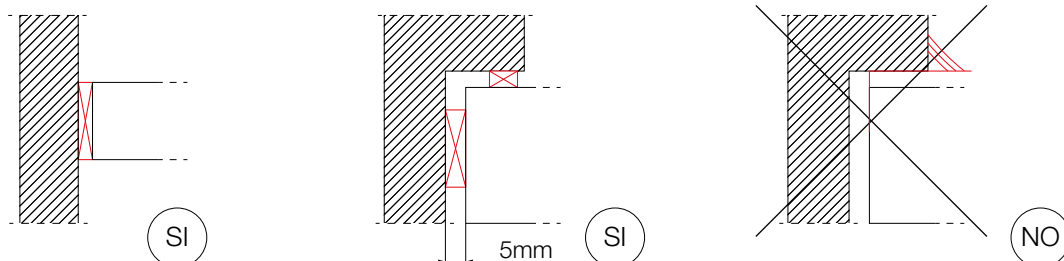

Inoltre, fondamentale è posare il serramento in modo corretto; per questo ALSistem consiglia di utilizzare il sistema Thermoposa con il quale si garantisce un sistema di posa del serramento ad alta efficienza termo-acustica. Grazie a questo sistema garantiamo l'adeguato isolamento del foro finestra ed un efficiente messa in opera del serramento nelle nuove costruzioni e nelle ristrutturazioni. Sono pertanto consigliati 3 principali interventi: corretta posa in opera del serramento, coibentazione del cassonetto, quando presente, taglio del marmo, se passante. Per maggiori indicazioni invitiamo a collegarsi a Thermoposa.com.

Manutenzione delle superfici in alluminio

A seguito dei forti tassi di inquinamento oramai raggiunti in tutti i paesi, specialmente nei grossi centri urbani e nelle zone costiere battute dal vento marino, è molto importante che le superfici in alluminio, a contatto con l'atmosfera, siano periodicamente pulite. Il nostro intento è quello di sensibilizzare il costruttore dei serramenti affinché possa di riflesso consigliare il cliente nel migliore dei modi.

E' buona norma tenere in considerazione 3 punti fondamentali:

- 1- quante volte deve essere eseguita l'operazione di pulizia nell'arco dell'anno
- 2- il periodo
- 3- il prodotto da usare

Ecco le risposte:

Il numero di interventi viene stabilito sulla base dello stato di inquinamento della zona in cui è ubicato il caseggiato, varia da 1 a 3 volte l'anno.

Il periodo può essere:

- a fine inverno
- a metà estate
- a metà autunno da scegliere a seconda del numero di interventi

Il prodotto per la pulizia è importante che sia neutro, un prodotto sbagliato potrebbe rovinare i materiali di diversa natura di cui è composto un serramento, (guarnizioni, sigillanti, marmi, etc...) e causare danni che potrebbero compromettere la funzionalità e la durata nel tempo dello stesso. Le caratteristiche di tali prodotti assieme alla frequenza di pulizia da adottare sono definite nei progetti di norma UNIMET12.04.270 ed E12.04.277.0. In mancanza di un prodotto neutro è preferibile utilizzare acqua tiepida con un panno non abrasivo.

Per una corretta installazione, manutenzione e pulizia dei serramenti, vi invitiamo inoltre a consultare le prescrizioni riportate sulle seguenti note tecniche Uncsaal, UX 42 guida alla posa in opera delle finestre ed UX 10 pulizia delle superfici di serramenti e facciate continue.

Fasi di verniciatura

1. Il ciclo di verniciatura offre la possibilità di ottenere sugli infissi un eccellente rivestimento protettivo superficiale ed una maggiore vivacità del colore;
2. lo strato deve avere uno spessore min. di 60 micron sulle parti a vista;
3. il materiale sarà sottoposto al seguente processo:
 - sgrassatura senza attacco
 - lavaggio
 - decapaggio alcalino con attacco
 - lavaggio
 - disossidazione
 - lavaggio
 - cromatazione
 - lavaggio in acqua demineralizzata
 - asciugatura a 75°C
 - verniciatura in polveri termoindurenti
 - polimerizzazione in forno

Tutte le lavorazioni eseguite su alluminio devono essere conformi a quanto previsto dal marchio di qualità Qualicoat®.

Fasi di anodizzazione

1. Lo strato ossido può variare secondo la zona di ubicazione del serramento da 15 a 20 micron (UNI 10681);
2. può essere normale o elettrocolore;
3. il materiale sarà sottoposto al seguente processo:
 - sgrassatura senza attacco
 - lavaggio
 - decapaggio alcalino con attacco (tranne le finiture lucide)
 - lavaggio
 - disossidazione
 - lavaggio
 - ossidazione in bagno acido solforico a 18/20°C, densità della corrosione 1,5[A]dmq
 - colorazioni inorganiche od organiche od elettrocolore (tranne argento)
 - lavaggio doppio
 - asciugatura
 - fase di fissaggio a caldo in ebollizione a Sali di nichel, fissaggio 2,5/3 minuti per ogni micron di spessore

Osservazione

Nella fase preventiva il progettista o il serramentista dovrà determinare il tipo di serramento da impiegare sulla base degli elementi forniti dal committente. Nella scelta o controllo si dovrà considerare, sulla base della pressione del vento, il momento d'inerzia necessario e scegliere il profilato occorrente nella gamma Planet. Ovviamente dovranno essere utilizzati adeguati accessori, tra quelli originali ALSistem, predisposti per la serie.

Dimensione e pesi profilati

Le dimensioni e i pesi indicati sui disegni dei profilati a catalogo sono quelli teorici e possono variare in funzione delle tolleranze dimensionali di estrusione (norma UNI EN 12020-2) e dal tipo di finitura. Anche la verniciatura, contribuisce ad aumentare gli spessori riducendo pertanto le sedi di inserimento delle guarnizioni e degli accessori. Questa variabilità potrebbe condizionare le dimensioni del taglio e di conseguenza quelle del serramento finito. Le differenze di taglio potranno aumentare in modo proporzionale anche in base al numero di ante per serramento. Si consiglia, nei primi lavori o in quelli con quantità importanti, di realizzare un campione reale per verificarne il corretto funzionamento.

Dimensioni taglio

Le dimensioni teoriche di taglio indicate nel presente catalogo si dovranno modificare in funzione della tipologia e sulla base della precisione della macchina di taglio che si sta utilizzando, (ad es. per porte a 2 ante ap.est. con maniglione antipanico, la fuga dovrà essere 8mm anziché 5mm; le finestre a 3 e 4 ante e le finestre di misure ridotte dovranno avere le ante più strette del teorico, di almeno 0,5mm ogni traverso, per evitare interferenze sulla rotazione, ecc...).

Consigli per un corretto assemblaggio

Per ottenere i migliori risultati utilizzando i profili Planet si consiglia di osservare attentamente tutte le voci di seguito riportate, atte a rinforzare tutti i punti deboli di una finestra comune, ottimizzando così le prestazioni offerte dal serramento.

Procedura corretta	Obiettivo
sigillare i profili tra loro nel giunto a 45°	evita infiltrazioni d'acqua evita la corrosione e l'ossidazione
sigillare i profili sul montante quando gli stessi vengono intestati	evita infiltrazioni d'acqua evita la corrosione e l'ossidazione
usare curve limite di utilizzo per la scelta del profilo	evita scelte inadeguate del profilo
sigillare il serramento sul perimetro tra profilo e controtelaio con sigillan-te BG1 seguendo le indicazioni contenute	evita infiltrazioni d'acqua e garantisce il giunto primario per 10 anni
nel programma Thermoposa®	evita infiltrazioni d'acqua e garantisce il giunto primario per 10 anni
utilizzare sempre il tassello di registro	facilita la posa in opera, inquadra meglio il telaio, isola i materiali e limita la trasmissione delle vibrazioni
proteggere tutte le lavorazioni effettuate sui profilati	evita la corrosione e l'ossidazione facendo aumentare la durata dell'infisso nel tempo
utilizzare controsagome durante il taglio a 45°	garantisce un taglio corretto al fine di ottenere una giunzione d'angolo perfetta

Certificazione accessori



I prodotti in alluminio verniciato sono certificati secondo le specifiche tecniche del: **QUALICOAT**



I prodotti in alluminio anodizzato sono certificati secondo le specifiche tecniche del: **EURAS EWAA QUALANOD**



Gli accessori per le gamme Top Slide sono prodotti da aziende certificate ISO9001 e ISO14001

Importante

Tutti i dati esposti in questo catalogo sono puramente indicativi e non impegnano in nessun modo la società la quale si riserva la possibilità di portare migliorie ai suoi prodotti in qualunque momento lo ritenga necessario. La società si riserva il diritto di proprietà del presente catalogo con la proibizione di riprodurlo o trasferirlo a terzi senza l'autorizzazione scritta.

Determinazione della trasmittanza termica dei nodi del sistema per serramenti Top Slide 160 Plus

Per la determinazione della trasmittanza termica dei profilati, l'intera serie Top Slide 160 Plus è stata certificata, dal laboratorio notificato IRCCOS, secondo la normativa di prodotto EN 14351-1:2016, seguendo il metodo di calcolo tramite "Flixo pro 8.0". Il codice di riferimento del documento rilasciato dal laboratorio corrisponde al n° 1994-CPD-RP1824.

Metodologia di analisi utilizzata

Il calcolo della trasmittanza termica è stato eseguito in accordo con la norma UNI EN ISO 10077-2:2017. Per i calcoli è stato utilizzato il software "Flixo pro 8.0". La scelta dei materiali dalla libreria del software "Flixo pro 8.0" è stata condotta sulla base della documentazione fornita dal committente. Nel caso di materiali non presenti nella libreria, questi sono stati inseriti secondo le specifiche fornite dal committente.

Andamento delle temperature e dei flussi di calore nel nodo laterale TT9003+TT90811

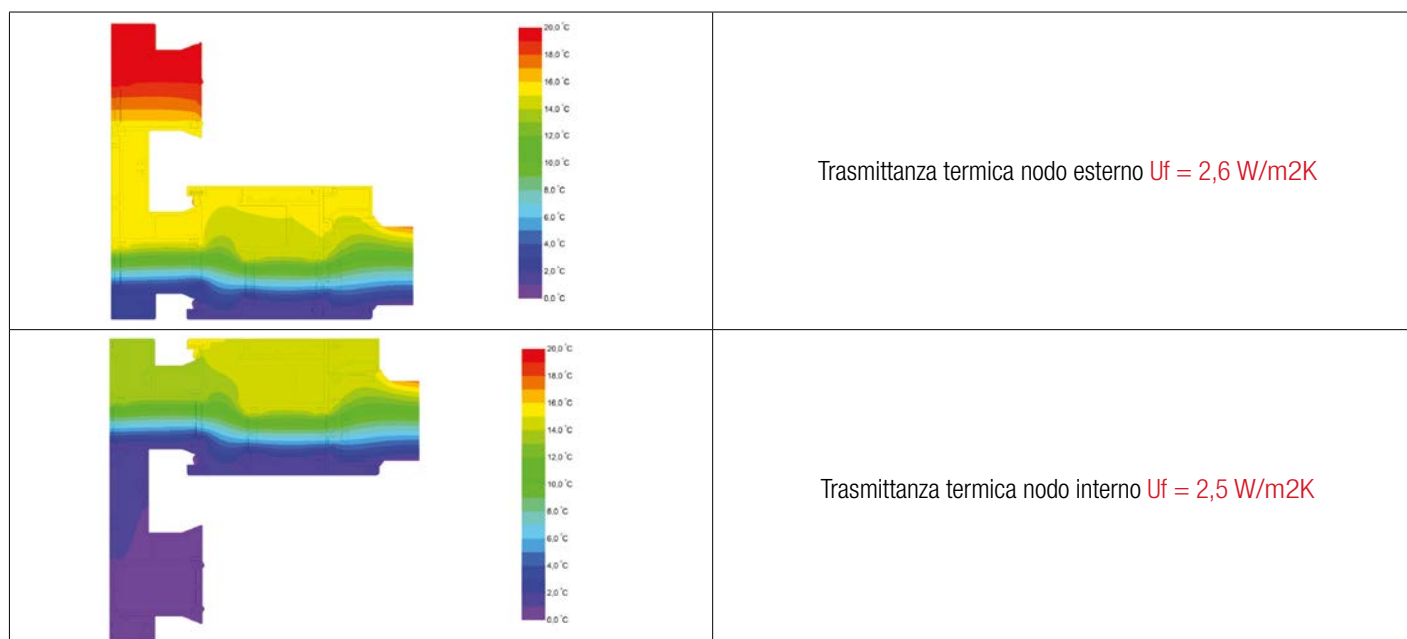

Andamento delle temperature e dei flussi di calore nel nodo centrale TT90811 + TT 90811

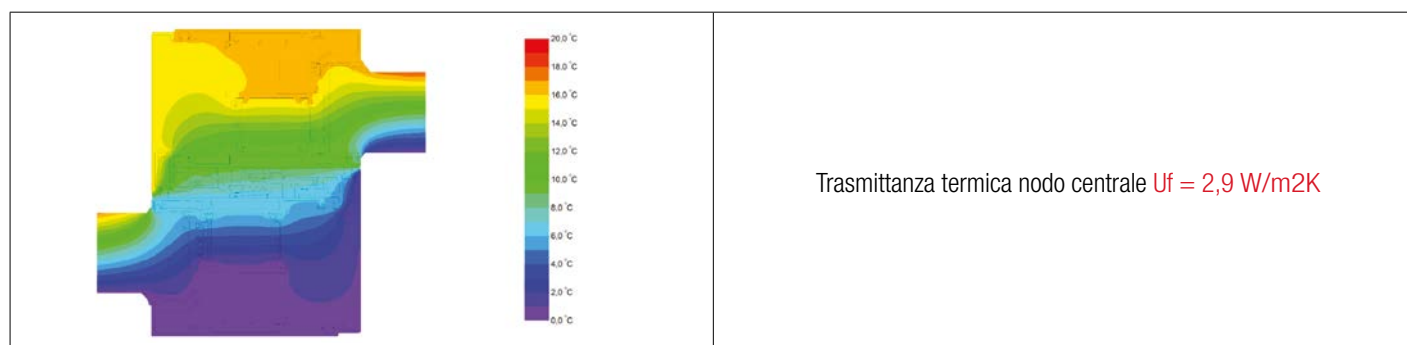

Certificazioni serie Top Slide 160 Plus

Per il principio di estendibilità i certificati sotto riportati sono validi per la serie Top Slide 160 Plus per le diverse tipologie di serramenti indicati in tabella.

PROVE	TIPOLOGIE SERRAMENTI
Misure del serramento	H =2.400 mm L =4.400 mm
Numero certificato	1994-CPD-RP0784
Valore prova permeabilità all'aria	classe 4
Valore prova tenuta all'acqua	classe E1200
Valore prova resistenza al vento	classe C4

PROVA	TIPOLOGIA SERRAMENTO	MISURE SERRAMENTO	N° CERTIFICATO	VETROCAMERA	RISULTATO
Valore prova acustica	Porta finestra 2 ante alzante scorrevole	H =2.400 mm L =2.200 mm	0016_DC_ACU_12_1	33PH/15/44PH da 44 dB	dB = 40 dB
Valore prova acustica	Porta finestra 2 ante alzante scorrevole	H =2.400 mm L =2.200 mm	0016_DC_ACU_12_1	33PH/15/33PH da 42 dB	dB = 38 dB

PROVA	NORMA DI RIFERIMENTO	CLASSE	CICLI	MISURE SERRAMENTO	PESO ANTA	DIMENSIONI ANTA
Test ciclico	UNE-EN 13126 - 16:2008	3	11000	H=2.200 L=2.400	327 Kg	H=2.000 L=1.200

General specifications

Lift and slide aluminium system, created with the range for Top Slide 160 Plus. The profiles are extruded in aluminium alloy EN AW-6060 (UNI EN 573-3), supply condition T5 and T6 in accordance with standard UNI EN 515 with dimensional tolerances and thicknesses compliant with standard UNI EN 12020-2. Alloy according to ALSistem formula. The thermal insulation will consist of 28mm polyamide 6.6 reinforced 25% with fibreglass; the strips are assembled by means of computerised mechanical rolling, and the mechanical characteristics of the strips must remain unaltered up to a maximum treatment temperature of 245°C. The production process is controlled in accordance with UAETC standards, the sliding values must be greater than 24 da N/mm. The fixed frame shall be 160mm deep, whilst the openable parts shall be 72mm deep. The sealing system shall be foam with PP coat; the threshold shall be not higher than 25mm and the rail shall be only in stainless steel AISI 316. The glazing must be sealed in accordance with the instructions shown in the catalogue and exclusively with original glazing bead gaskets. Appropriate drainage holes must be made on the fixed frame and on the moving frame in order to allow the correct drainage for the window/door. The limits of use of the profiles depend on their geometric characteristics, on the scope of the accessories and on the operating loads. The accessories used in the manufacture of the various types must be exclusively the originals designed especially for the system, as shown in the catalogue and distributed by the ALSistem licensees; the use of products other than those indicated or their partial or incorrect assembly shall render the test certificates and guarantee null and void. The manufacture and installation must be in accordance with the operating criteria indicated by ALSistem. The profiles shall be assembled with brackets in extruded or die-cast aluminium to be buttoned, pinned, crimped or screwed, the edges must be protected with acrylic, silicone or MS polymer sealants. The profiles must be protected and finished by means of normal surface treatments, anodic oxidation compliant with the "Qualanod" quality label or by painting with thermosetting polyester in powder form and oven-polymerised at temperatures between 185°C and 195°C, in accordance with the "Qualicoat" quality label and Thermoposa standards.

Materials

The doors and windows are made from aluminium alloy EN AW-6060 extruded profiles as indicated in standard EN 573-3.

The supply condition is within class T5 and T6 in accordance with standard EN 515. Dimensional tolerances comply with UNI 12020-2.

Alloy according to ALSistem formula.

Technical and dimensional characteristics

Profiles: light alloy EN AW-6060 (UNI EN 573-3) extrusions; they can be anodised and painted. Alloy according to ALSistem formula.

Sealing system: thermoplastic balloon gasket

Thermal frame insulation system: made using two lines of 28mm polyamide tubular spacers

Thermal sash insulation system: made using 28mm polyamide tubular spacers

Accessory system: slide and lift-slide, top quality hardware

Height of glass rebate: 22mm

Frame depth: 160mm

Sash depth: 72mm

Glass fastening: with glazing beads

Space for glass or panel: from 13mm to 63mm

Surface protection

The profiles can be protected by means of anodic oxidation with thickness category >15 micron as per standard UNI 10681, or by painting with thermosetting polyester in powder form and oven polymerised in accordance with the "Qualicoat" quality procedures and with standard UNI EN 12206-1.

Resistance of the finish

The surface finish must not suffer any corrosion or alterations in appearance for a period of time appropriate to the life of the product.

The characteristics required to ensure the behaviour in accordance with the type of environment are specified in standards UNI 10681 for oxidation and UNI EN 12206-1 for painting, bearing in mind that the key factors influencing weather resistance are proximity to the sea, atmospheric pollution, maintenance and cleaning also from rain.

Safety

In order to prevent physical harm or injury to users, the doors and windows must be designed in accordance with the relevant safety legislation, Italian Leg. Decree D.Lgs. 81/2008 e UNI 7697 . See “Usò e Manutenzione” by Thermoposa ALSistem.

Characteristics of the glazing

The glazing must be selected in accordance with performance criteria to meet the requirements of energy saving, sound insulation, solar radiation control, safety. Relevant standards: UNI EN ISO 10140-2, UNI EN 12488, UNI EN 572-1, UNI EN 12758, UNI EN 12150-1, UNI 11463 DM 2 Aprile 1998, Legge 90/2013 e DMSE 26/06/2015.

Gaskets

The gaskets must only be the originals designed for the system, guaranteeing its performance and complying with reference standards UNI 3952, UNI EN 12365-1/4.

Sealants

The sealants must comply with the provisions of reference standards UNI EN ISO 11600. These materials must not corrode the parts made of aluminium and its alloys with which they come into contact and must therefore be neutral.

Accessories

The accessories must be the original ones produced for the range and in accordance with the criteria indicated in UNI EN 13126-1/19 standards and with the safety legislation, Italian Leg. Decree 81/2008. Available ITT test report.

Performance

The Top Slide 160 Plus range meets the requirements of standards UNI EN 12207, UNI EN 12208, UNI EN 12210.

Mechanical resistance

The system and its accessories shall be resistant to the stress of use in accordance with the limits established in standard UNI EN 12365-1 and UNI EN 13126-1/19.

Sound insulation

The choice of the type of sound insulation for a door or window depends on the intended purpose of the location in which the frame is to be fitted and on the level of external noise; the behaviour of the door or window on site is influenced by factors that cannot be determined beforehand (height from the floor, orientation of noise sources, etc.). The sound insulation capacity can therefore be estimated to a large degree, based on window/door air permeability, with a minimum permeability value of 2, and on the sound insulation capacity of the glass. In accordance with the methodology described in reference standard UNI EN ISO 10140-2.

Thermal insulation

The choice of the heat insulation properties must be made on the basis of the energy saving requirements in accordance with law 10/91 and L.D.192/05 and update L.D.311/06 and of the environmental wellbeing requirements or with reference to standard UNI EN ISO 10077-1. The window/door thermal transmittance can be calculated from the transmittance values of the profiles and of the surfaces in accordance with standard UNI EN ISO 10077-1 using the formula:

$$U_w = (A_g \cdot U_g + A_f \cdot U_f + I_g \cdot \psi) \div (A_g + A_f)$$

Certifications

It is possible to ask the manufacturer of the windows/doors, or alternatively the local licensee, for a photocopy of the test reports relating to specific properties.

CE Marking UNI EN 14351-1

CE marking is OBLIGATORY and is the system to which all manufacturers of doors and windows must comply in order to be able to sell their products in the European Union. The Manufacturer, or its representative, with its headquarters in the EEA [European Economic Area] is responsible for affixing the CE marking to its product, on a label applied to the product, on its packaging or on its accompanying commercial documents.

Standard UNI EN 14351-1 applies to windows, glass doors, external pedestrian doors, external doors on escape routes, roof windows/skylights (including those resistant to external fire), ribbon windows, coupled windows and double windows. These doors/windows can have one or more leaves, with moving leaves and fixed parts, opening inwards or outwards, operated manually or automatically, completely or partially glazed, with or without a frame to contain the glass, with or without built-in shielding devices.

Standard UNI EN 14351-1 does not apply to:

- windows, glass doors and pedestrian doors with fire-resistant and smoke-proof characteristics
- internal doors (EN 14351-2)
- external obscuring shutters (UNI EN 13659)
- revolving doors
- windows situated on escape routes

The standard relates to certain voluntary and/or obligatory requirements:

- Watertightness
- Release of hazardous substances
- Impact resistance
- Wind resistance
- Load-bearing capacity of safety devices
- Sound insulation
- Thermal insulation
- Glass radiance (light transmission)
- Air permeability

Factory Production Control (FPC)

Factory production control is a system implemented by the manufacturer under its own responsibility, in order to ensure that the structural characteristics of the product are maintained over time within certain limits. The manufacturer must establish certain documented procedures, which indicate the methods that the personnel responsible for various controls must implement in order to monitor the process assigned to them frequently and accurately. The manufacturer is obliged to guarantee the traceability of the product by using codes or other methods. By means of a diagram, the manufacturer is also obliged to inform the purchaser of instructions relating to the use, handling, installation, maintenance and cleaning of the product. The installation characteristics, however, are not analysed. Refer to our Thermoposa manuals.

Laboratory Test (ITT)

The characteristics of the door/window are assessed on the finished product complete with its metal fittings, double glazing, panels and all the accessories and treatments that render it ready for use. Any manufacturer who requests it can obtain the results of the tests (ITT) on the doors/windows directly from Al sistem or from the local licensee, which grants the right to use the results of the certificates of the ITTs received from the Laboratory, by means of a cascading agreement between the parties. The manufacturer is responsible for the product's compliance with the European standards indicated in the draft standard and found in the national standards (UNI standards).

Installation

In order for the window to operate properly, it is very important to pay extremely close attention to the vertical positioning and levelling of the frame, and then to seal it using Thermoposa self-expanding tapes, following the advice in the example shown below, also checking that the openings are sufficiently filled (shimming the glass 1-2 mm out of square), so that, with the adjustment of the materials, there is no deterioration of operation over time.

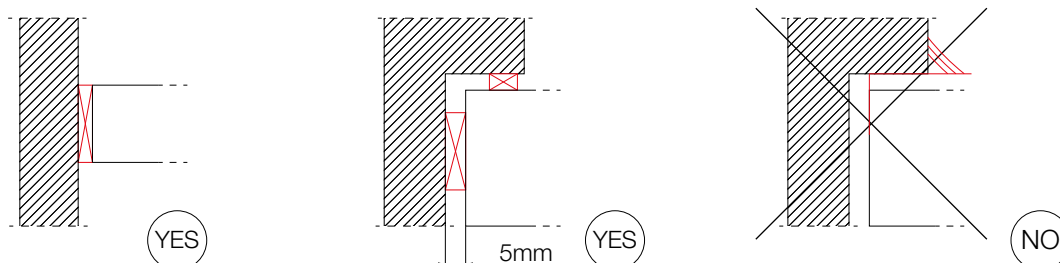

Our company, that in the field of exterior doors has always been ahead in research and development in the high-efficiency thermo-acoustic solutions, adopts Thermoposa system to guarantee a correct redevelopment of the window hole.

The **Thermoposa** System includes 3 main interventions: - Proper installation of the window

- Insulation of the box
- Cutting Marble, whether through

Maintenance of the aluminium surfaces

In view of the high amounts of pollution now reached in all countries, particularly in large cities and in coastal areas beaten by the sea wind, it is very important for aluminium surfaces that are in contact with the atmosphere to be cleaned regularly. Our intention is to raise the awareness of the manufacturers of doors and windows so that they can in turn advise THE CLIENT as well as possible.

It is good practice to take 3 fundamental points into consideration:

- 1- how often the cleaning operation must be carried out over the course of the year
- 2- the period
- 3- the product to be used

Here are the answers:

The number of cleaning operations depends on the level of pollution in the area in which the building is located, ranging from 1 to 3 times a year.

The period may be:

- at the end of winter
- in the middle of summer
- in the middle of autumn, depending on the number of cleaning operations

It is important that the product to be used for cleaning is neutral; using the wrong product could ruin the various different materials of which a door or window consists (gaskets, sealants, marble, etc) and cause damage that could compromise the efficiency and life of the product.

The characteristics of these products as well as the frequency of the cleaning to be adopted are defined in draft standards UNIMET12.04.270 and E12.04.277.0.

If no neutral product is available, it is preferable to use warm water with a nonabrasive cloth.

In order to install, maintain and clean the doors and windows correctly, we also suggest that you consult the instructions contained in the following Uncsaal technical notes: UX 42 guide to installing windows UX 10 cleaning of surfaces of doors/windows and continuous facades. Refer to our Thermoposa manuals.

Painting phases

1. The painting cycle offer the possibility of obtaining an excellent protective coating on the surface of the frames and a greater brightness of colour;
2. The layer must have a min. thickness of 60 micron on the visible parts;
3. the material shall be subjected to the following process:
 - removal of grease/dirt without etching
 - washing
 - alkaline (or acid) pickling with etching
 - washing
 - deoxidising
 - washing
 - chromate treatment
 - washing in demineralised water
 - drying at 75°C
 - painting in thermosetting powder coating
 - oven polymerisation

All operations carried out on aluminium must comply with the provisions of the “Qualicoat” quality label.

Anodisation phases

1. The oxide layer may vary from 15 to 20 micron (UNI4522-66), according to the area in which the door/window is located;
2. it can be normal or electro-colour;
3. the material shall be subjected to the following process:
 - removal of grease/dirt without etching
 - washing
 - alkaline pickling with etching (except for shiny finishes)
 - washing
 - deoxidising
 - washing
 - oxidation in sulphuric acid bath at 18/20°C, density of corrosion 1.5[A]dmq
 - inorganic or organic colouring or electro-colour (except for silver)
 - double washing
 - drying
 - hot fixing boiling with nickel salts, fixing 2.5/3 minutes for every micron of thickness

Observation

During the preliminary phase the project manager or fitter must determine the type of door/window to be used depending on the elements provided by the client. During the selection or inspection, the necessary moment of inertia must be considered depending on the wind pressure and the required profile chosen from the Slide range. Obviously, the appropriate accessories must be used from the original ALSistem accessories, provided for the Slide range.

Profile dimensions and weights

The dimensions and weights indicated on the drawings of the profiles in the catalogue are theoretical and can vary according to the extrusion dimensional tolerances (Standard UNI EN 12020-2) and to the type of finish. Painting also adds to the thickness, thus reducing the housings for inserting the gaskets and accessories. This variability could influence the dimensions of the cut and consequently those of the finished door/window. The differences in cut can increase also in proportion to the number of leaves per door/window. It is advisable, in initial works or in those with large quantities, to create a true sample to check that it works properly.

Cut dimensions

The theoretical dimensions of cut indicated in this catalogue must be altered according to the type and depending on the precision of the cutting machine being used, (e.g. for double-leaf doors opening outwards with panic exit bar, the space must be 8 mm rather than 5 mm etc.).

Advice for correct assembly

To obtain the best results when using Top Slide 160 profiles, it is advisable to pay careful attention to all of the following points, designed to reinforce all of the weak points of a normal window, thus optimising the performance offered by the window.

Correct procedure	Objective
seal the profiles together in the join at 45°	prevents water seepage, prevents corrosion
seal the profiles on the jamb when they are faced	prevents water seepage, prevents corrosion
use limit curves to select the profile	avoids choosing the wrong profile
seal the window or door on the perimeter between profile and counter-frame with Thermoposa self-expanding tapes	prevents water seepage
always use the wall spacer and the screw for fixing	facilitates installation, ensures better frame positioning, insulates materials and minimises the transmission of vibrations
protect all the work carried out on the profiles	prevents corrosion increasing the life of the frame over time
use counterprofile during the 45° cut	guarantees a correct cut in order to obtain a perfect angle joint
use multi-purpose corner brackets	guarantees high-quality joints and solid in time

Accessory certification



The painted aluminium products are certified according to the technical specifications of:
QUALICOAT



The anodised aluminium products are certified according to the technical specifications of:
EURAS EWAA QUALANOD



The accessories for the Top Slide 160 ranges are produced by ISO9001 and ISO14001 certified companies

Important

All the information provided in this catalogue is for guidance purposes only and in no way commits the company, which reserves the right to make improvements to its products whenever it deems this to be necessary. The company reserves the right of ownership of this catalogue and it is prohibited to reproduce or transfer it to third parties without written authorisation.

Determination of thermal transmittance of the sections of the Top Slide 160 Plus system

For the determination of the thermal transmittance of the profiles, the entire series Top Slide 160 Plus has been certified by the notified laboratory IRcCOS, according to the product standards EN 14351-1:2016, following the method of calculation by software "Flixo pro 8.0".

The reference of the document issued by the laboratory correspond to n° 1994-CPD-RP1824.

Methodology analysis used

The calculation of the thermal transmittance was performed according to the UNI EN ISO 10077-2:2017. For the calculations we used the software "Flixo pro 8.0". The choice of materials from the "Flixo pro 8.0" software library was based on the documentation provided by the client. In the case of absent materials in the library, these have been put in according to the specifications provided by the client.

Trend of temperatures and heat flows in the lateral section TT9003+TT90811

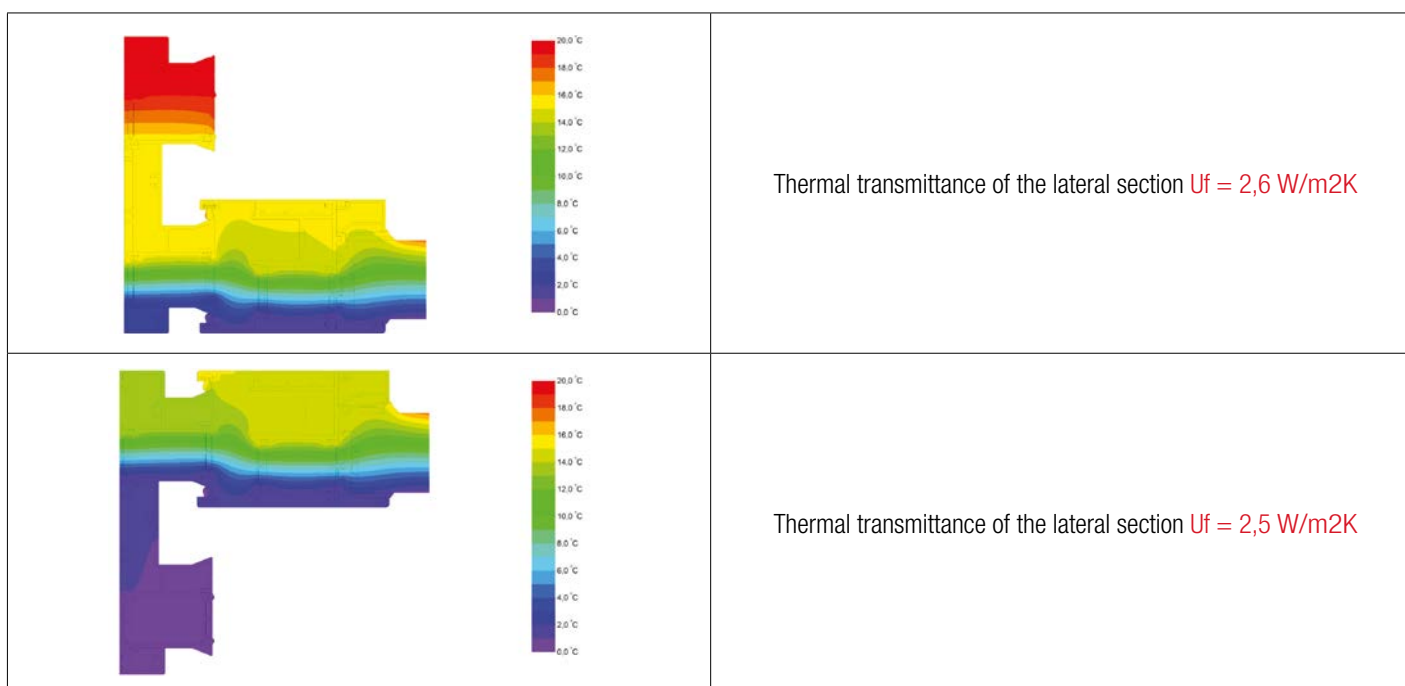

Trend of temperatures and heat flows in the central section TT90811 + TT 90811

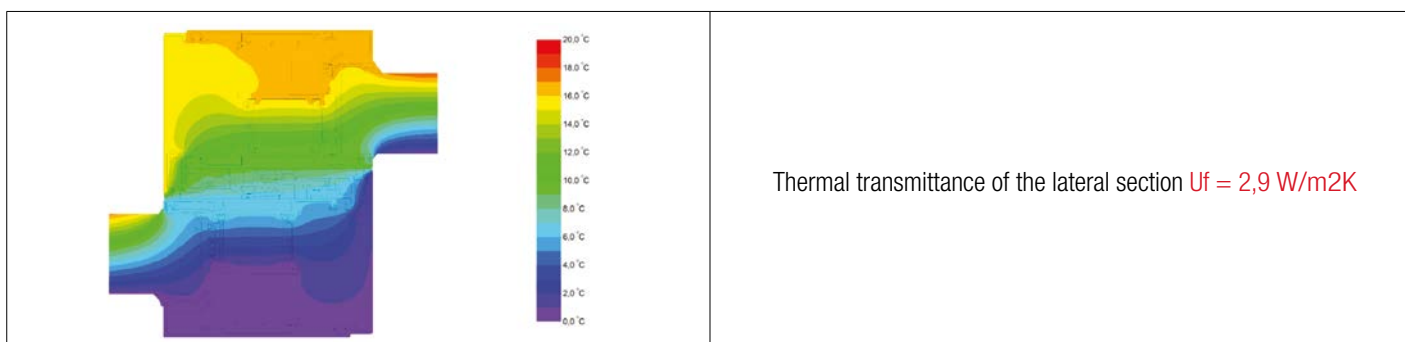

Top Slide 160 Plus range certifications

The Top Slide 160 Plus system has been subjected to the tests shown in the table for the different types of door and window.

CAPITOLATO
Specification

PROVE		TIPOLOGIE SERRAMENTI
		Franch door, 2-leaf, lift&slide
window size		H =2.400 mm L =4.400 mm
certificate number		1994-CPD-RP0784
permeability air value		classe 4
watertightness value		classe E1200
resistance to wind load value		classe C4

PROVA	TIPOLOGIA SERRAMENTO	MISURE SERRAMENTO	N° CERTIFICATO	VETROCAMERA	RISULTATO
acoustic value	Porta finestra 2 ante alzante scorrevole	H =2.400 mm L =2.200 mm	0016_DC_ACU_ 12_1	33PH/15/44PH da 44 dB	dB = 40 dB
acoustic value	Porta finestra 2 ante alzante scorrevole	H =2.400 mm L =2.200 mm	0016_DC_ACU_ 12_1	33PH/15/33PH da 42 dB	dB = 38 dB

PROVA	NORMA DI RIFERIMENTO	CLASSE	CICLI	MISURE SERRAMENTO	PESO ANTA	DIMENSIONI ANTA
Cycle test	UNE-EN 13126 - 16:2008	3	11000	H=2.200 W=2.400	327 Kg	H=2.000 W=1.200

CURVE LIMITE DI UTILIZZO
Limit curves

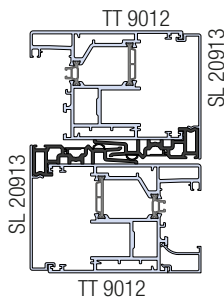
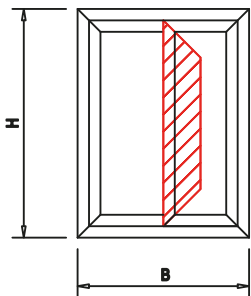

$J = 78.41 \text{ cm}^4$

freccia max 1/300

VERIFICARE CHE LA FRECCIA DEL PROFILO SIA COMPATIBILE COL VETRO IMPIEGATO

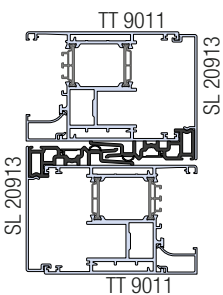
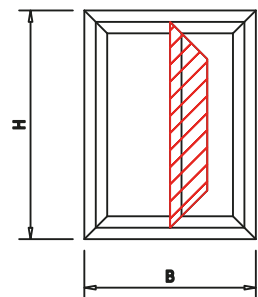
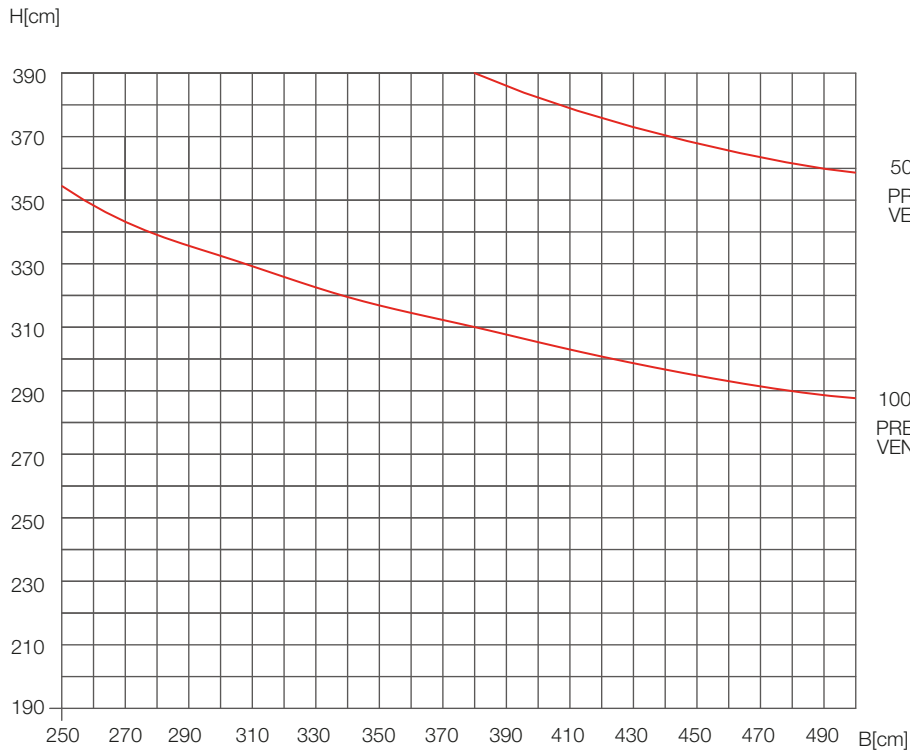

$J = 74.77 \text{ cm}^4$

freccia max 1/300

VERIFICARE CHE LA FRECCIA DEL PROFILO SIA COMPATIBILE COL VETRO IMPIEGATO

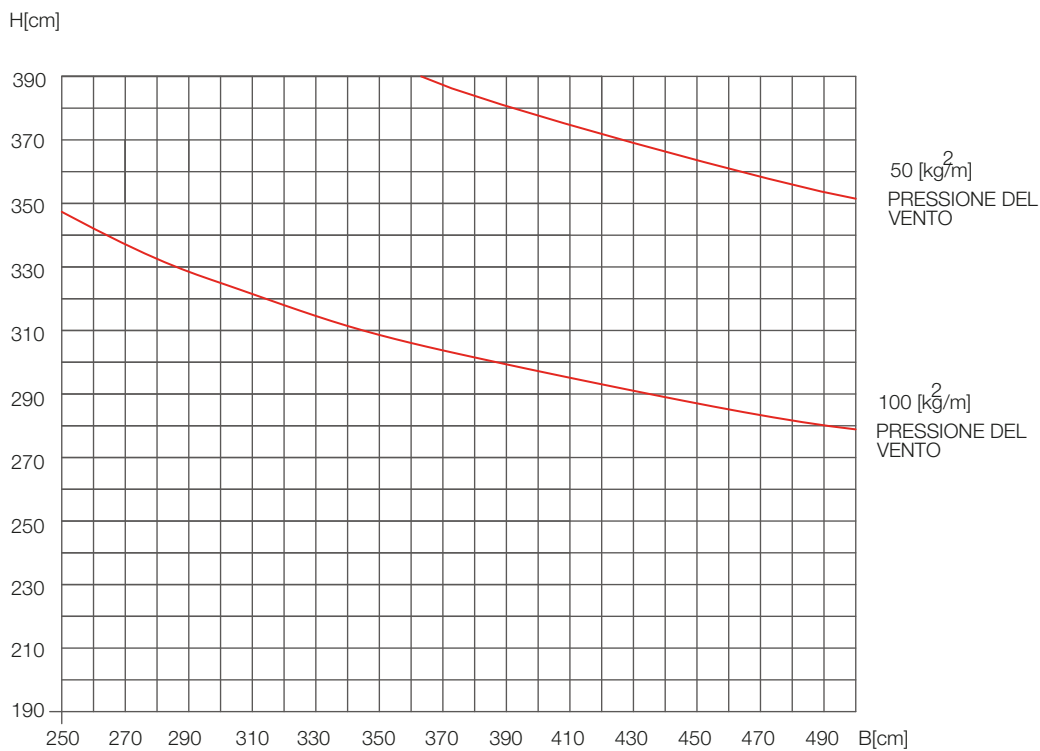

I DIAGRAMMI DI PORTATA SONO CALCOLATI SU BASE TEORICA IN FUNZIONE DELLE CARATTERISTICHE INERZIALI DEI PROFILI

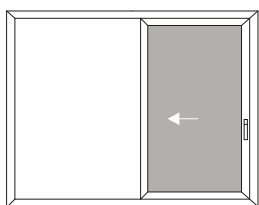

1A
monovia
1 rail

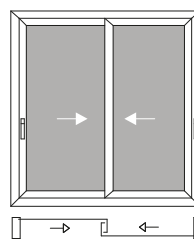

2A
2 vie - 2 ante
2 rail-2 sash

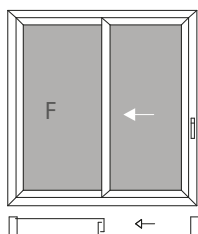

3A
2 vie - 1 anta+fisso
2 rail-1 sash+fixed

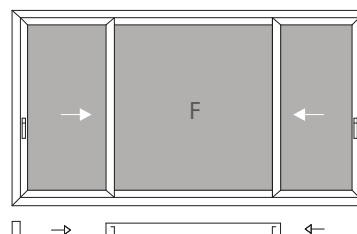

4A
2 vie - 2 anta+fisso
2 rail-2 sash+fixed

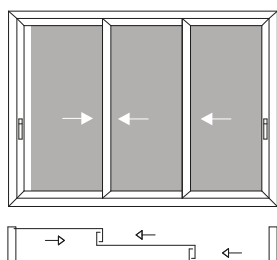

5A
3 vie - 3 ante
3 rail-3 sash

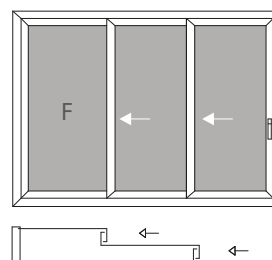

6A
3 vie - 2 ante+fisso
3 rail-2 sash+fixed

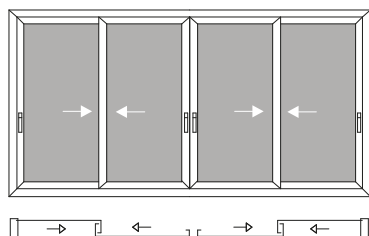

7A
2 vie - 4 ante
2 rail-4 sash

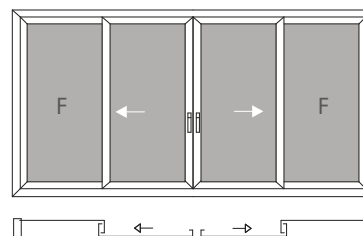



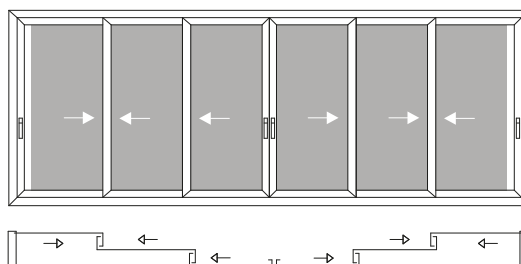



8A
2 vie - 2 ante+2 fissi
2 rail-2 sash+2 fixed



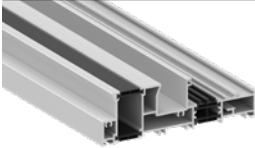
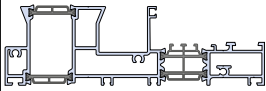
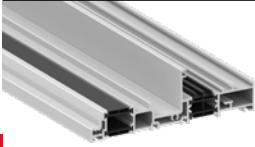
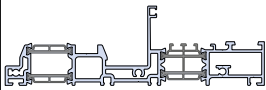
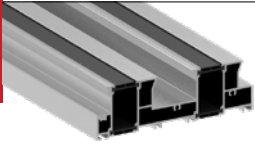
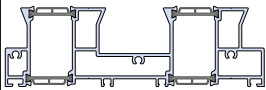

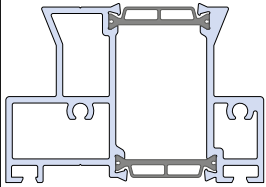

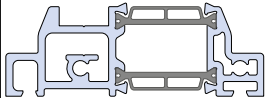
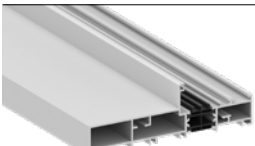
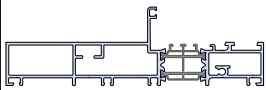
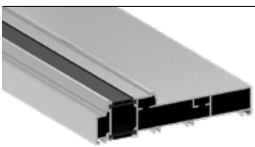
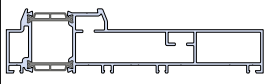
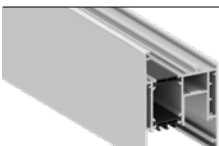
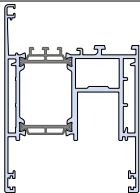

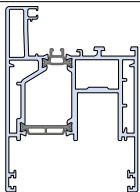
9A
3 vie - 6 ante
3 rail-6 sash

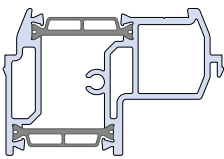
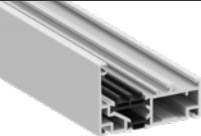
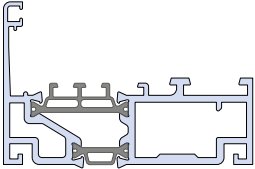

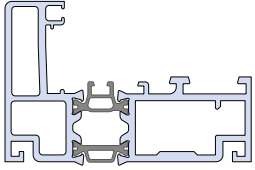
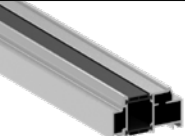
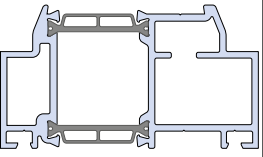

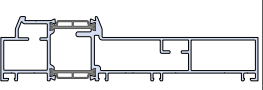
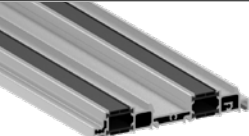
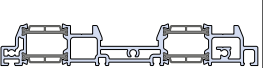
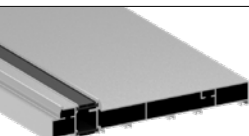
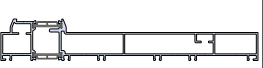
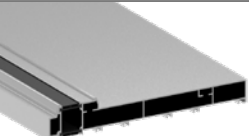
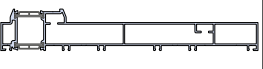
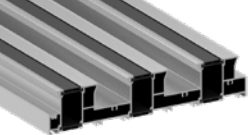
ANTA MINIMA realizzabile 700mm
ANTA MASSIMA realizzabile 3250mm
*Verificare carico spinta vento e peso vetro





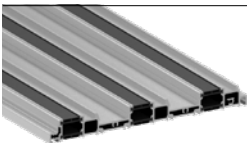
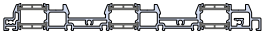

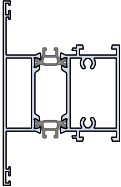
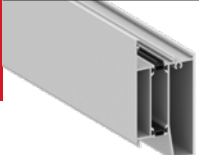
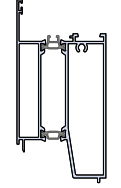
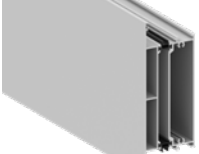
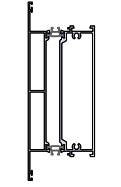
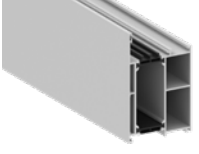
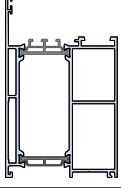
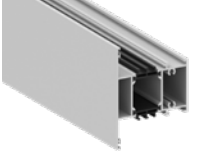
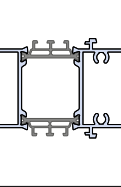

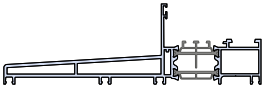
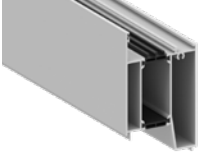
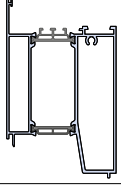
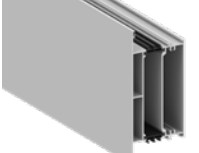
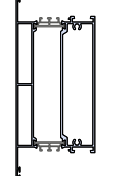
TIPOLOGIE
COSTRUTTIVE
Constructor type

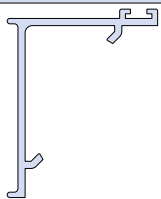
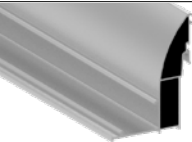
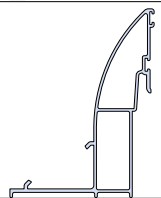
	Sagoma	Art.	Descrizione	Peso gr/m	Jxx cm ⁴ Jyy cm ⁴
		TT 90801	Telaio orizzontale superiore fisso più apribile <i>Horizontal upper frame fixed and openable</i>	3232	300,78 27,94
		TT 90802	Soglia fisso più apribile <i>Threshold fixed and openable</i>	2892	258,10 10,16
		TT 9003	Telaio orizzontale superiore 2 vie <i>2 ways horizontal upper frame</i>	3516	349,75 38,96
		TT 9004	Telaio orizzontale superiore monovia <i>Single way horizontal upper frame</i>	1797	33,71 19,61
		TT 9005	Soglia monovia <i>Single way threshold</i>	1347	24,87 3,27
		TT 90806	Telaio verticale fisso <i>Vertical fixed frame</i>	2485	213,84 10,11
		TT 9009	Telaio monobinario esterno verticale 2 vie <i>External single rail vertical frame 2 ways</i>	2501	241,56 14,61
		TT 90811	Anta liscia <i>Smooth sash</i>	2719	74,77 52,46
		TT 90812	Anta con aletta tubolare <i>Sash with tubular fin</i>	3044	78,41 65,61

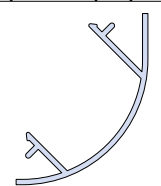
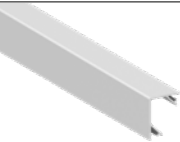
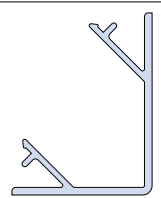
	Sagoma	Art.	Descrizione	Peso gr/m	Jxx cm ⁴ Jyy cm ⁴
		TT 9014	Incontro ante frontali <i>Frontal sash match</i>	1326	16,98 8,31
		TT 90821	Anta liscia nodo centrale ridotto <i>Smooth sash for lowered central section</i>	1583	34,33 6,77
		TT 90822	Anta con aletta tubolare nodo centrale ridotto <i>Sash with tubular fin for lowered central section</i>	1800	35,94 11,45
		TT 9023	Telaio verticale monovia <i>Single way vertical frame</i>	1541	32,42 11,11
		TT 9024	Telaio monobinario interno verticale 2 vie <i>Internal single rail vertical frame 2 ways</i>	2597	225,25 15,03
		TT 9025	Soglia 2 vie <i>2 ways threshold</i>	2812	36,13 15,00
		TT 9026	Telaio monobinario interno verticale 3 vie <i>Internal single rail vertical frame 3 ways</i>	3507	801,00 18,86
		TT 9027	Telaio monobinario esterno verticale 3 vie <i>External single rail vertical frame 3 ways</i>	3411	828,00 18,37
		TT 9033	Telaio orizzontale superiore 3 vie <i>3 ways horizontal upper frame</i>	5250	1224,00 58,32

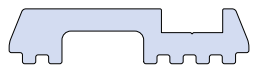
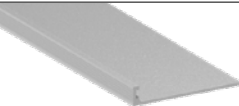
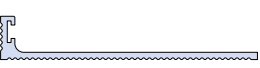
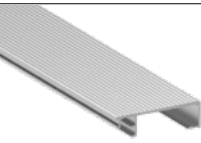
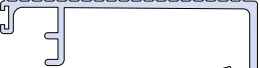
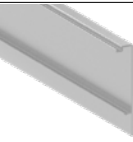





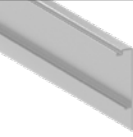

ELENCO PROFILI
List of profiles

	Sagoma	Art.	Descrizione	Peso gr/m	Jxx cm ⁴ Jyy cm ⁴
		TT 9035	Soglia 3 vie <i>3 ways threshold</i>	4277	970,18 10,08
		TT 51839	Traverso da 92mm per anta TT 90812 <i>92mm transom for TT 90812 sash</i>	1747	18,70 24,15
		TT 51848	Zoccolo riportato per anta TT 90812 <i>Fitted base for TT 90812 sash</i>	2259	25,50 75,50
		TT 51858	Fascia da 165mm per anta TT 90812 <i>165mm crossbeam for TT 90812 sash</i>	3259	44,00 200,00
		TT 61815	Telaio per fissi in abbinamento con monovia <i>Frame for fixed to be combined with single way</i>	1741	40,23 62,89
		TT 61839	Traverso da 92mm per anta TT 90811 <i>92mm transom for TT 90811 sash</i>	1829	39,51 26,30
		TT 61844	Telaio abbinamento Top Slide 160 con Planet 62Plus <i>Top Slide 160 Frame to be combined with Planet 62Plus</i>	2348	191,53 7,56
		TT 61848	Zoccolo riportato per anta TT 90811 <i>Fitted base for TT 90811 sash</i>	2332	51,15 84,50
		TT 61858	Fascia da 165mm per anta TT 90811 <i>165mm crossbeam for TT 90811 sash</i>	3341	74,93 241,63

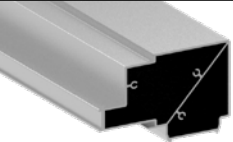
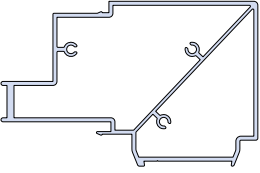
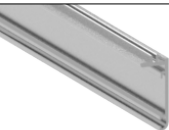
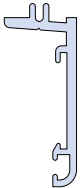
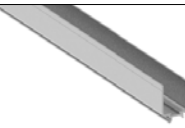
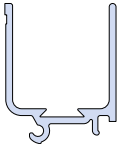

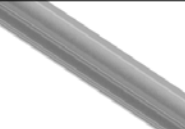

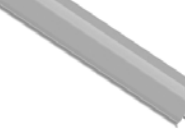
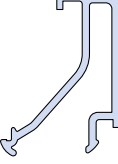

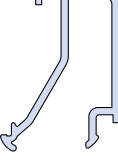
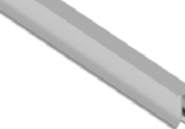
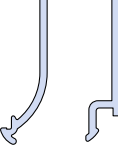
	Sagoma	Art.	Descrizione	Peso gr/m	Jxx cm ⁴ Jyy cm ⁴
		SL 20817	Profilo interno di chiusura monovia <i>Internal closing profile single way</i>	587	-
		SL 20818	Profilo esterno di chiusura monovia <i>External closing profile single way</i>	1532	-
		SL 20819	Profilo copri vite per SL 20817 e SL 20818 <i>Cover screw profile for SL 20817 and SL 20818</i>	450	-
		SL 20820	Profilo coprivite retto <i>Cover screw profile 90°</i>	626	-
		SL 20907	Soglia ribassata <i>Lowered threshold</i>	1072	-
		SL 20908*	Profilo per soglia a filo pavimento (disponibile su richiesta) <i>Threshold profile flush with the floor (available on request)</i>	804	-
		SL 20910	Profilo copri soglia <i>Threshold hiding profile</i>	926	-
		SL 20913	Labirinto centrale <i>Central maze</i>	438	-
		SL 20914	Coprifuga per unione fisso e monovia <i>Leak hiding to be combined with fixed and single way</i>	132	-

* UTILIZZARE SEMPRE CLIP ACP 50122/ * Use clip ACP 50122 always

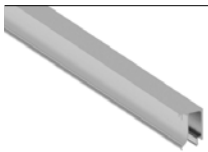
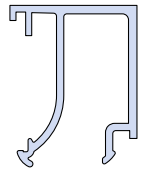
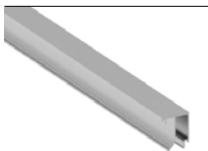
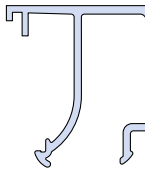

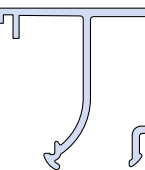
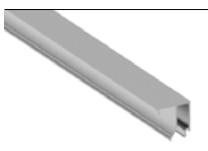
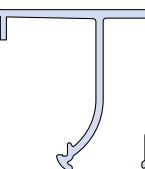
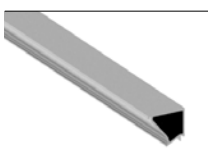
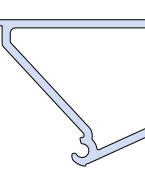
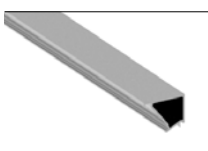
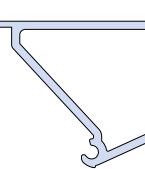
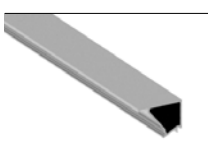
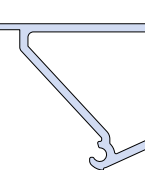

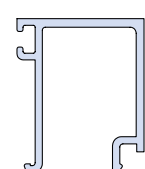

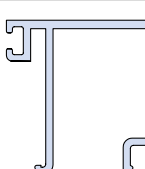

ELENCO PROFILI
List of profiles

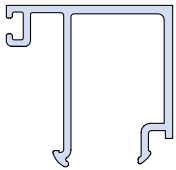
	Sagoma	Art.	Descrizione	Peso gr/m	Jxx cm ⁴ Jyy cm ⁴
		SL 20915	Labirinto centrale per unione fisso e monovia da abbinare a TT 6115 <i>Central maze for fixed and single way to be combined with TT 6115</i>	402	-
		SL 20916	Montante d'angolo per chiusura 90° <i>Corner mullion to 90° closing</i>	2880	190,97 83,72
		SL 20973	Battuta riportata da 30mm per telai <i>Fitted 30mm rabbet for frame</i>	226	-
		PL 1325*	Fermavetro Easysun da 24,5mm <i>24,5mm Easysun glazing bead</i>	348	-
		PL 1404*	Fermavetro retto da 3,5mm <i>3,5mm smooth glazing bead</i>	190	-
		PL 1407	Fermavetro retto da 7mm <i>7mm smooth glazing bead</i>	206	-
		PL 1411	Fermavetro retto da 10,5mm <i>10,5mm smooth glazing bead</i>	252	-
		PL 1414	Fermavetro retto da 14mm <i>14mm smooth glazing bead</i>	257	-
		PL 1418	Fermavetro retto da 17mm <i>17mm smooth glazing bead</i>	268	-

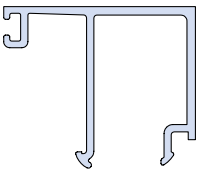
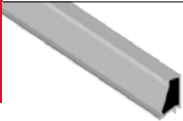
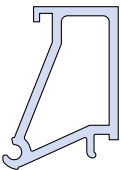
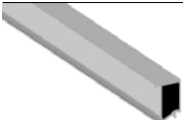
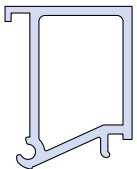
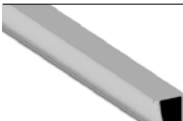
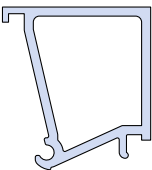
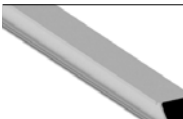
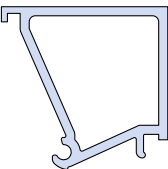

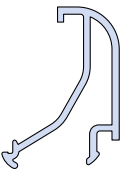
* UTILIZZARE SEMPRE ACP 5027/ * Use ACP 5027 always

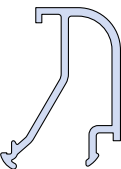
	Sagoma	Art.	Descrizione	Peso gr/m	Jxx cm ⁴ Jyy cm ⁴
		PL 1421	Fermavetro retto da 21mm <i>21mm smooth glazing bead</i>	290	-
		PL 1425	Fermavetro retto da 24,5mm <i>24,5mm smooth glazing bead</i>	304	-
		PL 1428	Fermavetro retto da 27,5mm <i>27,5mm smooth glazing bead</i>	312	-
		PL 1432*	Fermavetro retto da 31,5mm <i>31,5mm smooth glazing bead</i>	331	-
		PL 1435*	Fermavetro retto di sicurezza da 35mm <i>35mm tubular smooth glazing bead</i>	434	-
		PL 1439*	Fermavetro retto di sicurezza da 38,5mm <i>38,5mm tubular smooth glazing bead</i>	445	-
		PL 1442*	Fermavetro retto di sicurezza da 41,5mm <i>41,5mm tubular smooth glazing bead</i>	454	-
		PL 14121	Fermavetro retto con portaguarnizione da 21mm <i>Flat glazing bead for 21mm fixed</i>	280	-
		PL 14125	Fermavetro retto con portaguarnizione da 25mm <i>Flat glazing bead for 25mm fixed</i>	313	-

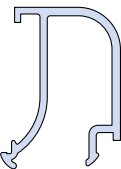



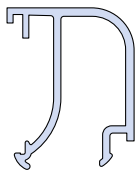

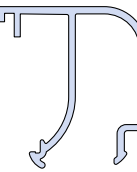
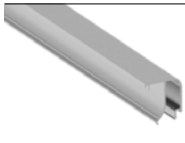
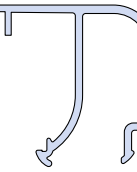
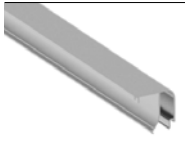
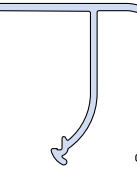
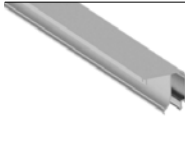
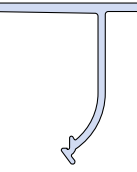
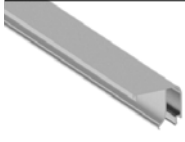
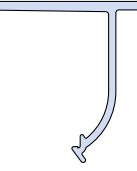
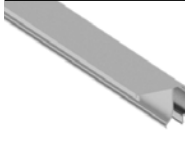
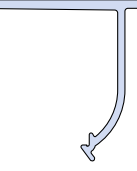
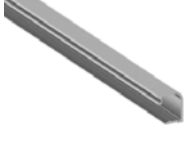
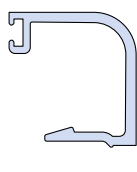
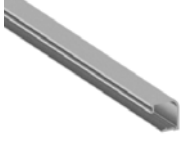
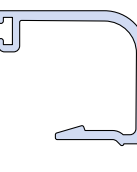

* UTILIZZARE SEMPRE ACP 5027/ * Use ACP 5027 always

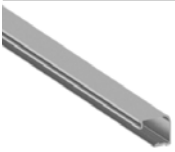
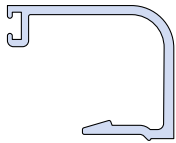
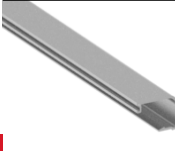
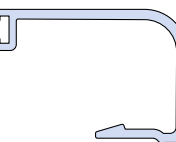
	Sagoma	Art.	Descrizione	Peso gr/m	Jxx cm ⁴ Jyy cm ⁴
		PL 14128	Fermavetro retto con portaguarnizione da 27,5mm <i>Flat glazing bead for 27,5mm fixed</i>	323	-
		PL 14132	Fermavetro retto con portaguarnizione da 32mm <i>Flat glazing bead for 32mm fixed</i>	338	-
		PL 14214*	Fermavetro retto di sicurezza da 14mm <i>14mm tubular smooth glazing bead</i>	329	-
		PL 14221*	Fermavetro retto di sicurezza da 21mm <i>21mm tubular smooth glazing bead</i>	353	-
		PL 14225*	Fermavetro retto di sicurezza da 24,5mm <i>24,5mm tubular smooth glazing bead</i>	370	-
		PL 14228	Fermavetro retto di sicurezza da 27,5mm <i>27,5mm tubular smooth glazing bead</i>	389	-
		PL 1511	Fermavetro arrotondato da 10mm <i>10mm rounded glazing bead</i>	238	-
		PL 1514	Fermavetro arrotondato da 14mm <i>14mm rounded glazing bead</i>	247	-
		PL 1518	Fermavetro arrotondato da 17,5mm <i>17,5mm rounded glazing bead</i>	257	-

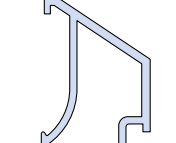
* UTILIZZARE SEMPRE ACP 5027/ * Use ACP 5027 always

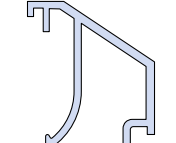
	Sagoma	Art.	Descrizione	Peso gr/m	Jxx cm ⁴ Jyy cm ⁴
		PL 1521	Fermavetro arrotondato da 21mm <i>21mm rounded glazing bead</i>	279	-
		PL 1525	Fermavetro arrotondato da 24,5mm <i>24,5mm rounded glazing bead</i>	290	-
		PL 1528	Fermavetro arrotondato da 27,5mm <i>27,5mm rounded glazing bead</i>	301	-
		PL 1532	Fermavetro arrotondato da 31,7mm <i>31,7mm rounded glazing bead</i>	317	-
		PL 1535	Fermavetro arrotondato da 35mm <i>35mm rounded glazing bead</i>	337	-
		PL 1539	Fermavetro arrotondato da 38,5mm <i>38,5mm rounded glazing bead</i>	352	-
		PL 1542	Fermavetro arrotondato da 41,5mm <i>41,5mm rounded glazing bead</i>	365	-
		PL 15221*	Fermavetro raggiato per clip da 21mm <i>21mm radial glazing bead</i>	259	-
		PL 15225*	Fermavetro raggiato per clip da 24,5mm <i>24,5mm radial glazing bead</i>	275	-

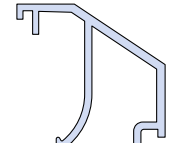
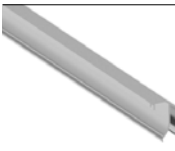
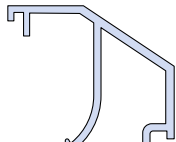
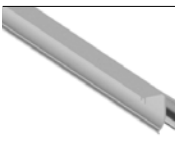
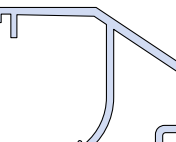
* UTILIZZARE SEMPRE CLIP ACP 50122/ * Use clip ACP 50122 always

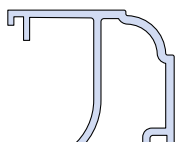
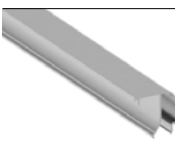
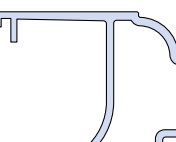
	Sagoma	Art.	Descrizione	Peso gr/m	Jxx cm ⁴ Jyy cm ⁴
		PL 15228*	Fermavetro raggiato per clip da 27,5mm <i>27,5mm radial glazing bead</i>	272	-
		PL 15232*	Fermavetro raggiato per clip da 31,7mm <i>31,7mm radial glazing bead</i>	305	-
		PL 1818	Fermavetro smussato da 17,5mm <i>17,5mm bevelled glazing bead</i>	236	-
		PL 1821	Fermavetro smussato da 21mm <i>21mm bevelled glazing bead</i>	258	-
		PL 1825	Fermavetro smussato da 24,5mm <i>24,5mm bevelled glazing bead</i>	270	-
		PL 1828	Fermavetro smussato da 27,5mm <i>27,5mm bevelled glazing bead</i>	279	-
		PL 1832	Fermavetro smussato da 31,7mm <i>31,7mm bevelled glazing bead</i>	296	-
		PL 1928	Fermavetro modanato da 27,5mm <i>27,5mm moulded glazing bead</i>	298	-
		PL 1932	Fermavetro modanato da 31,7mm <i>31,7mm moulded glazing bead</i>	317	-

* UTILIZZARE SEMPRE CLIP ACP 50122/ * Use clip ACP 50122 always

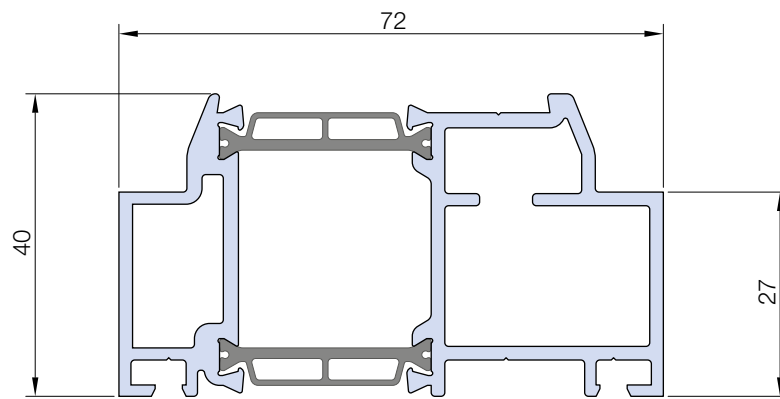

TT 9023

1541 gr/m

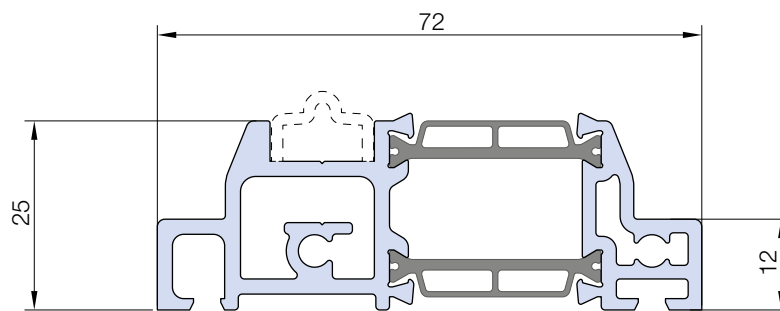

TT 9005

1347 gr/m

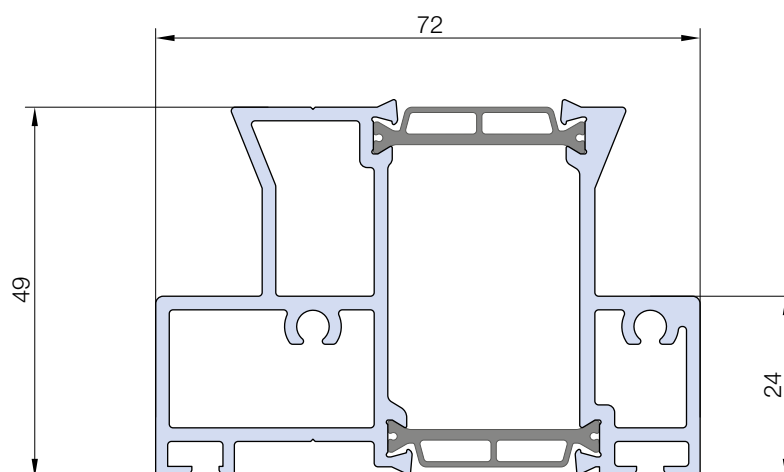

TT 9004

1797 gr/m

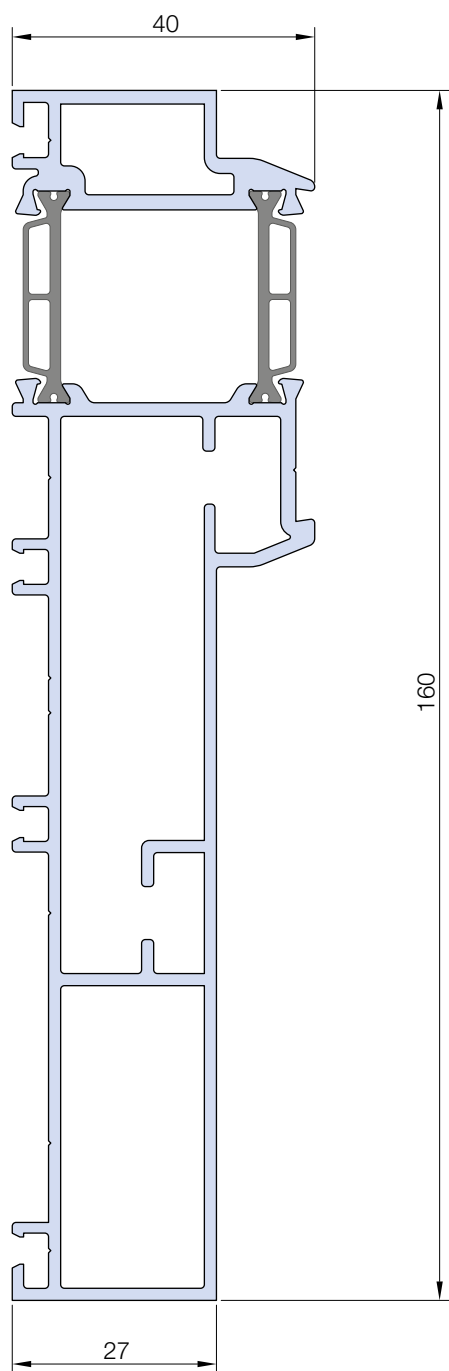

TT 9009
2501 gr/m

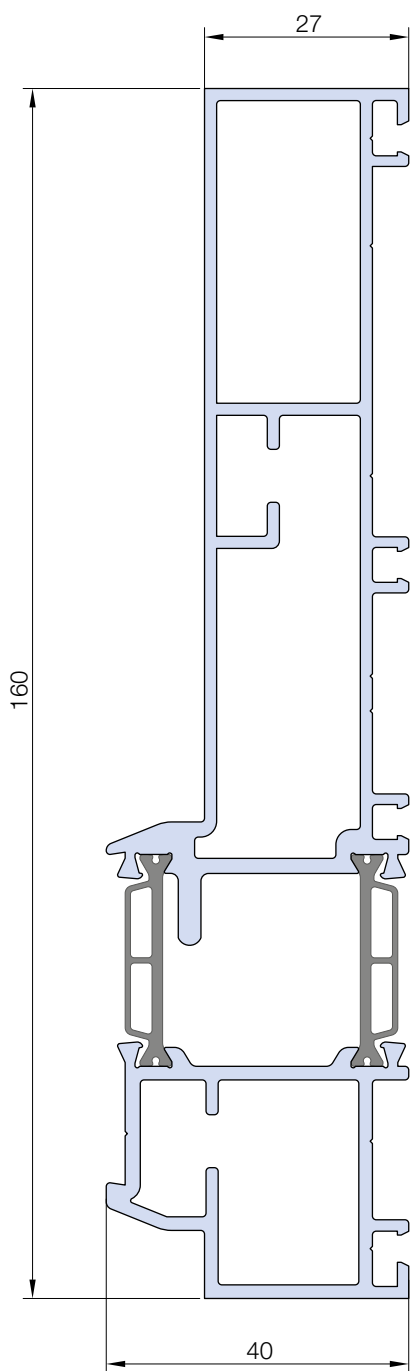

TT 9024
2597 gr/m

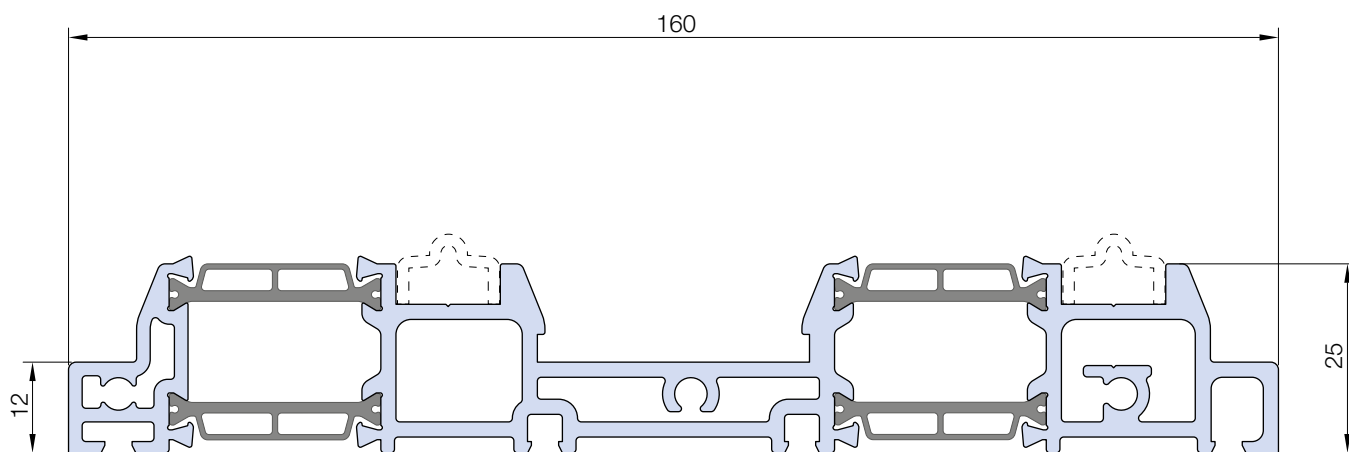

TT 9025

2812 gr/m

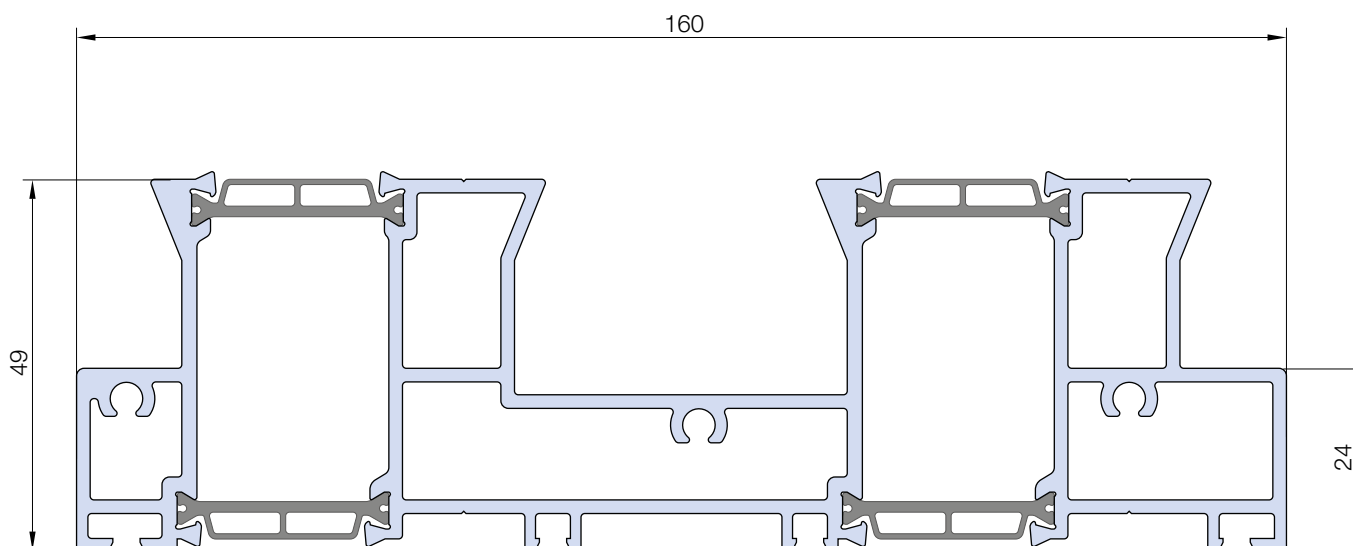

TT 9003

3516 gr/m

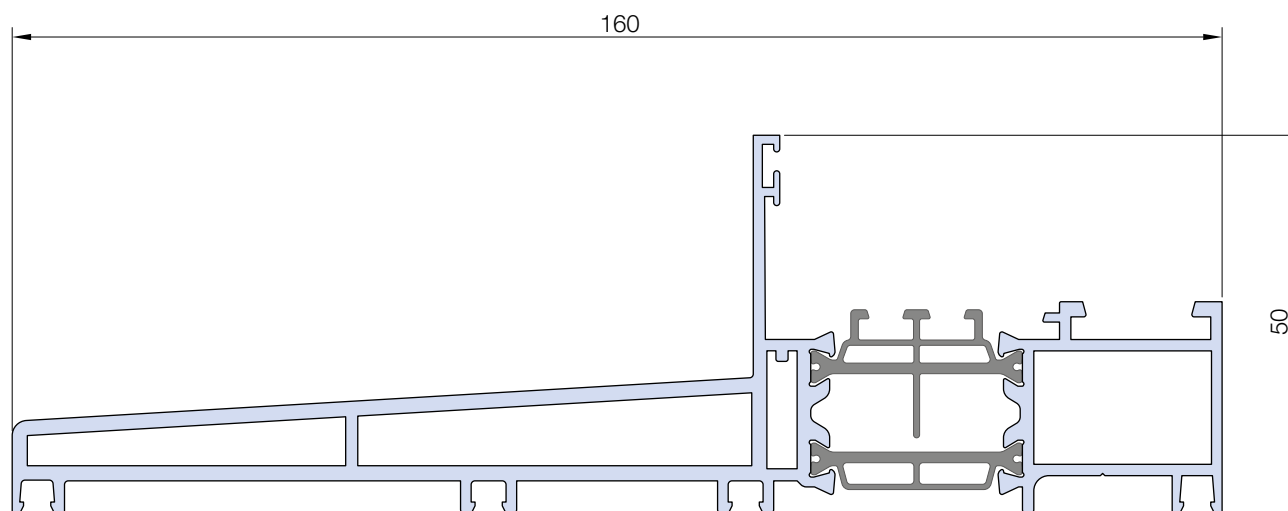

TT 61844

2362 gr/m

SAGOMARIO
Profile representation

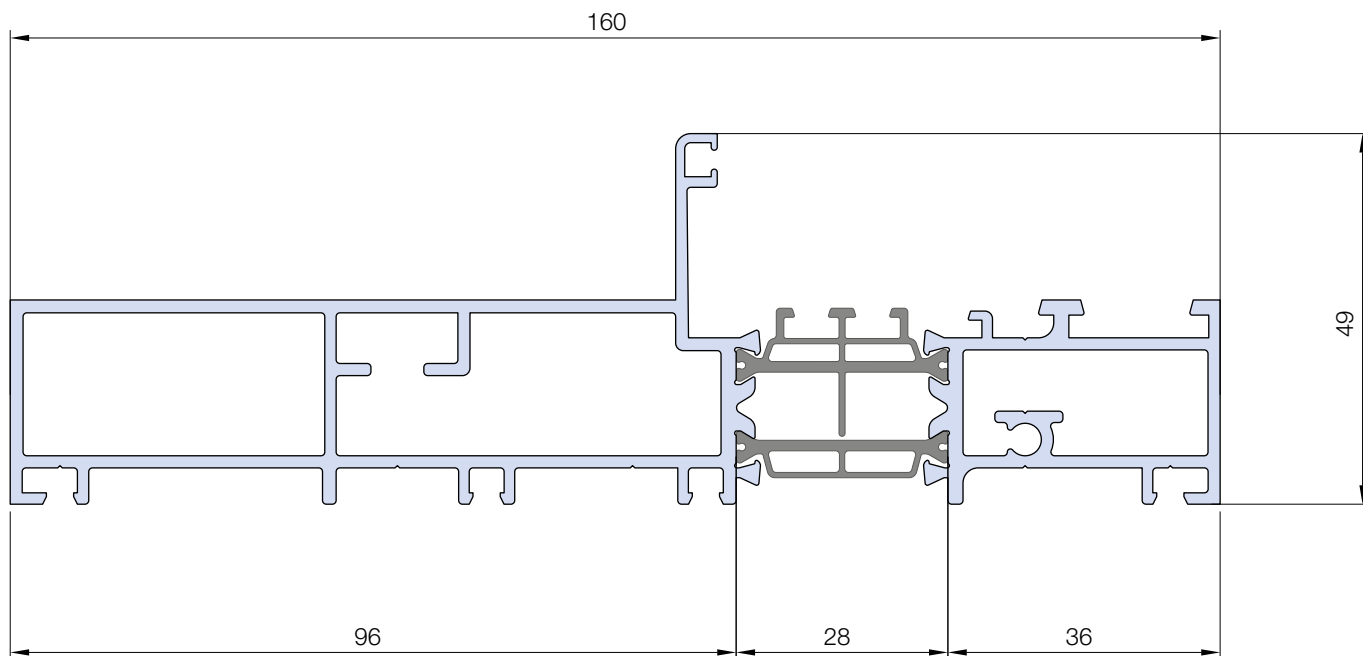

TT 90806

2499 gr/m

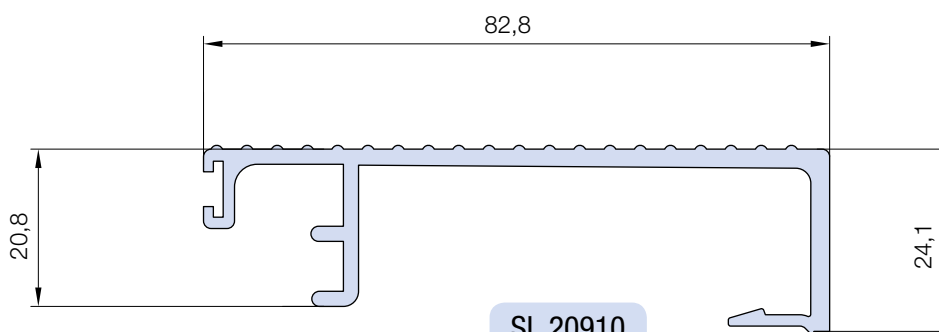

SL 20910

926 gr/m

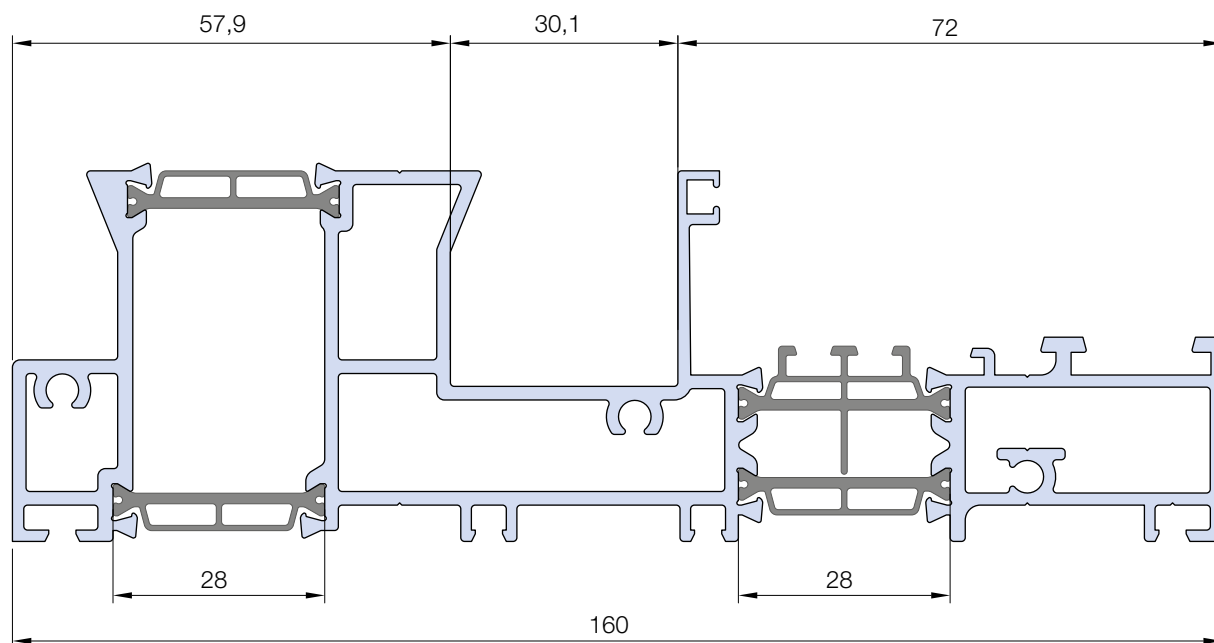

TT 90801

3246 gr/m

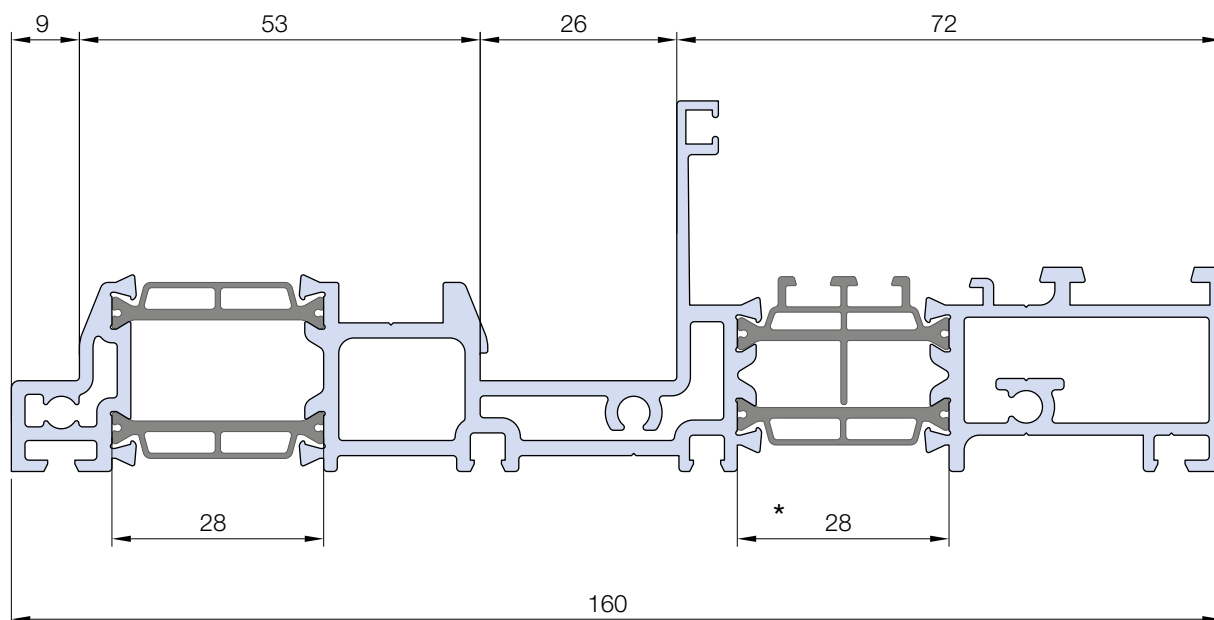

TT 90802

2906 gr/m

* UTILIZZARE SEMPRE CLIP ACP 50122/ * Use clip ACP 50122 always

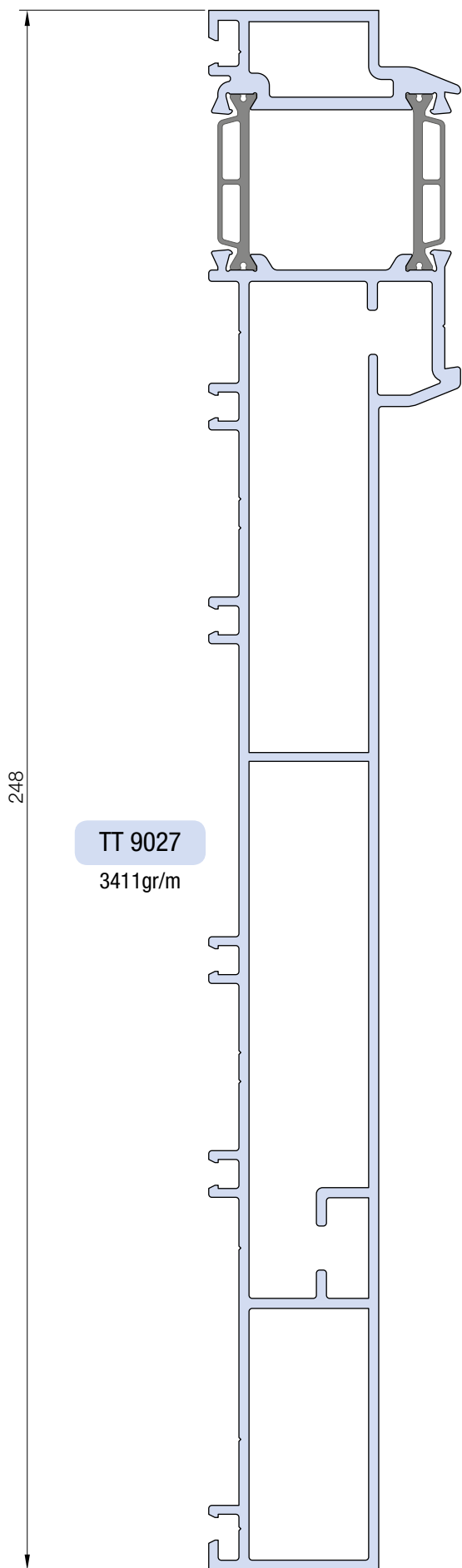

TT 9027
3411gr/m

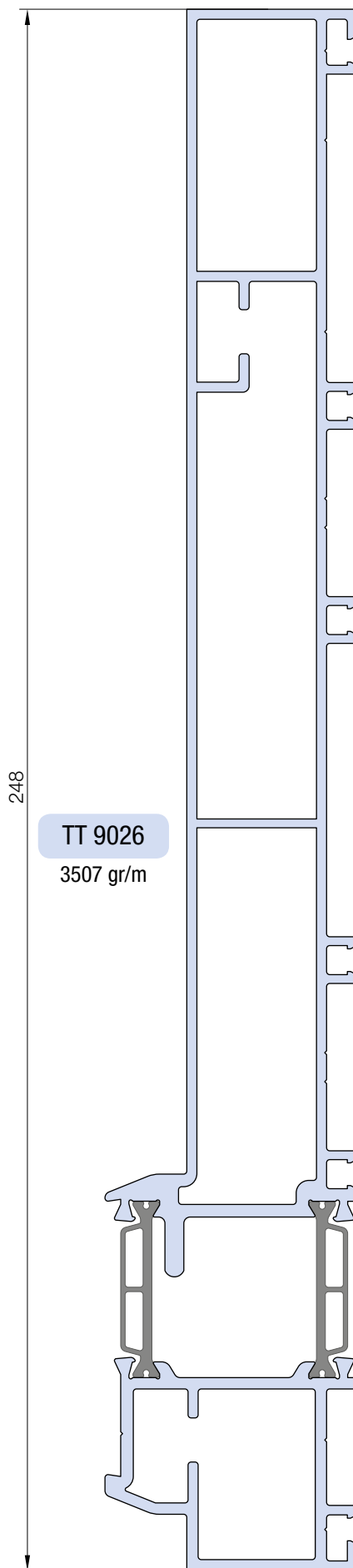

TT 9026
3507 gr/m

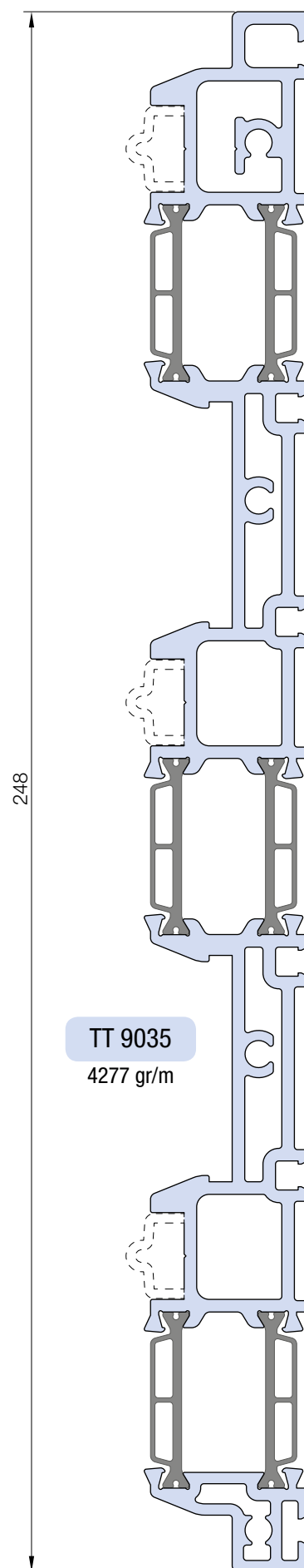
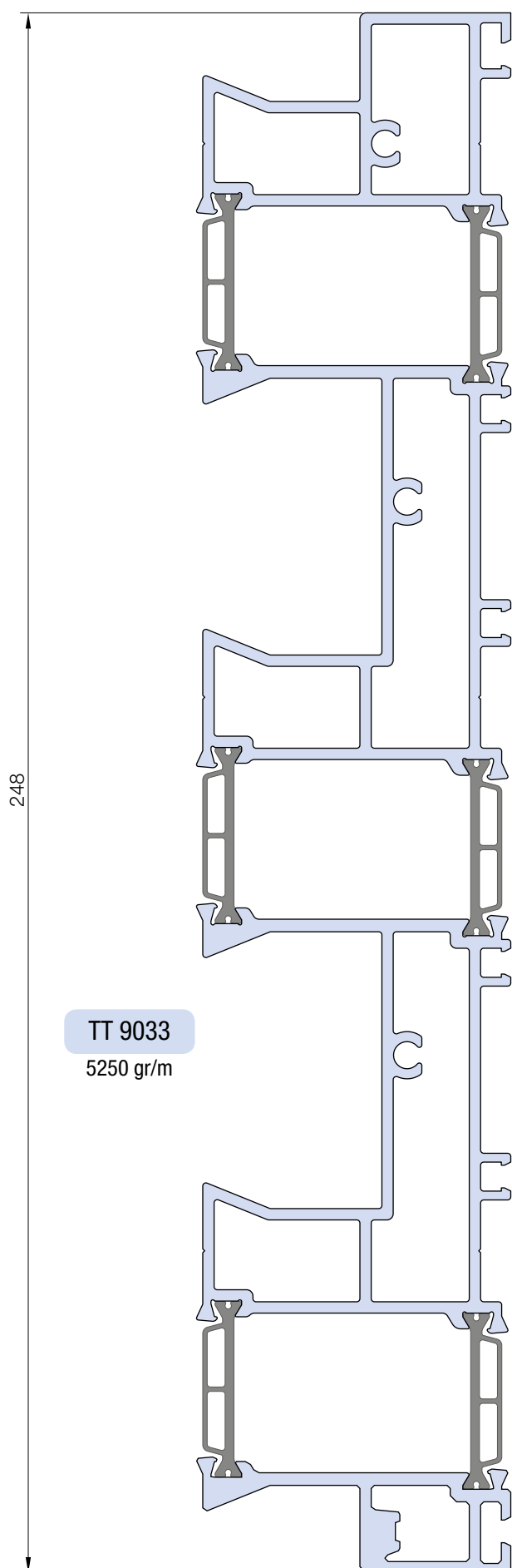

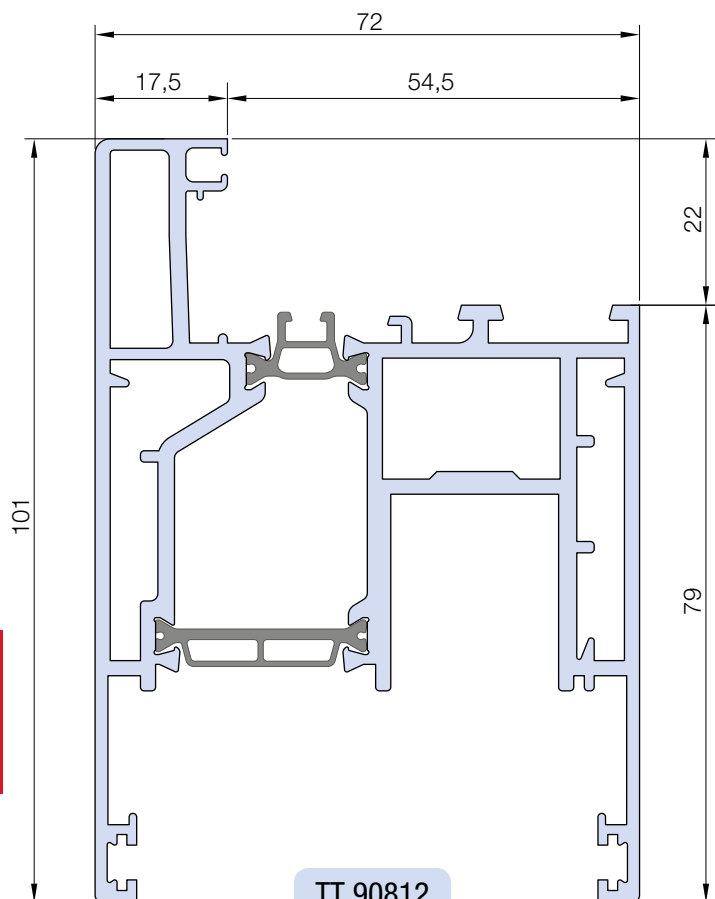

TT 90812

3031gr/m

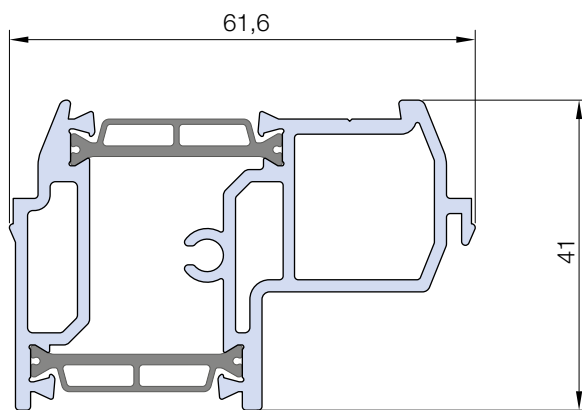

TT 9014

1326 gr/m

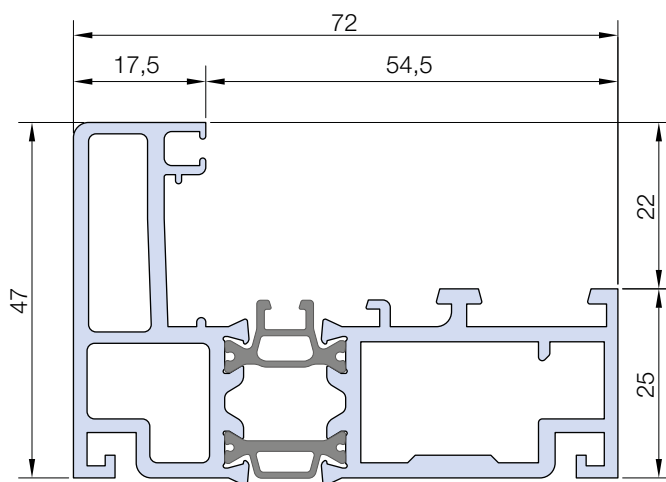

TT 90822

1800 gr/m

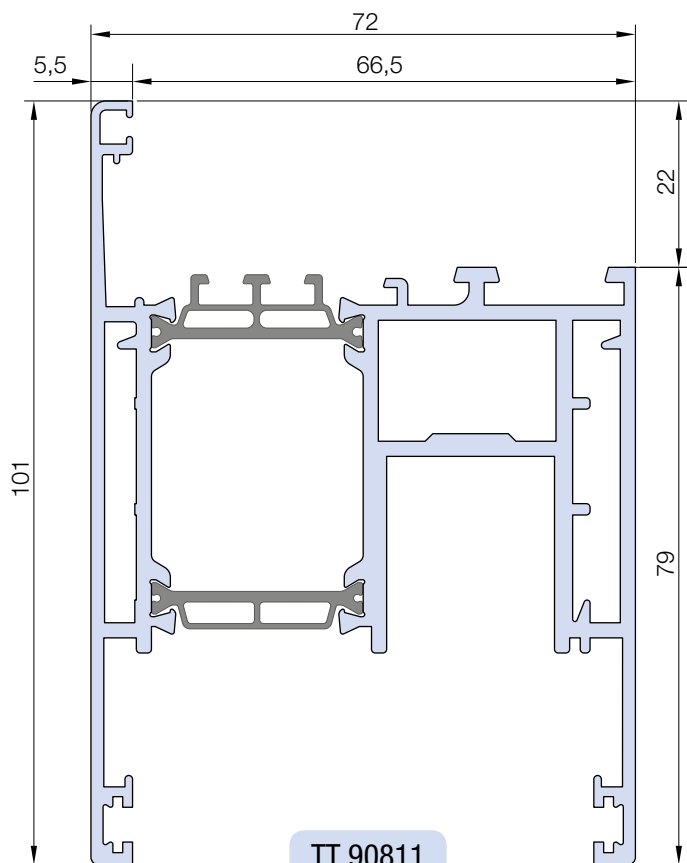

TT 90811

2707 gr/m

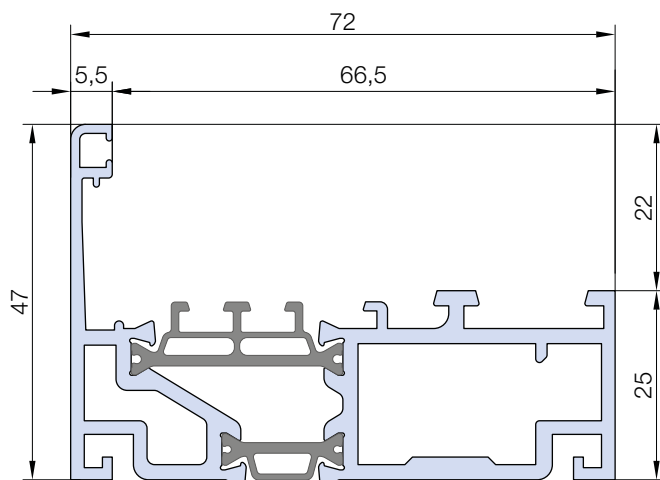

TT 90821

1583 gr/m

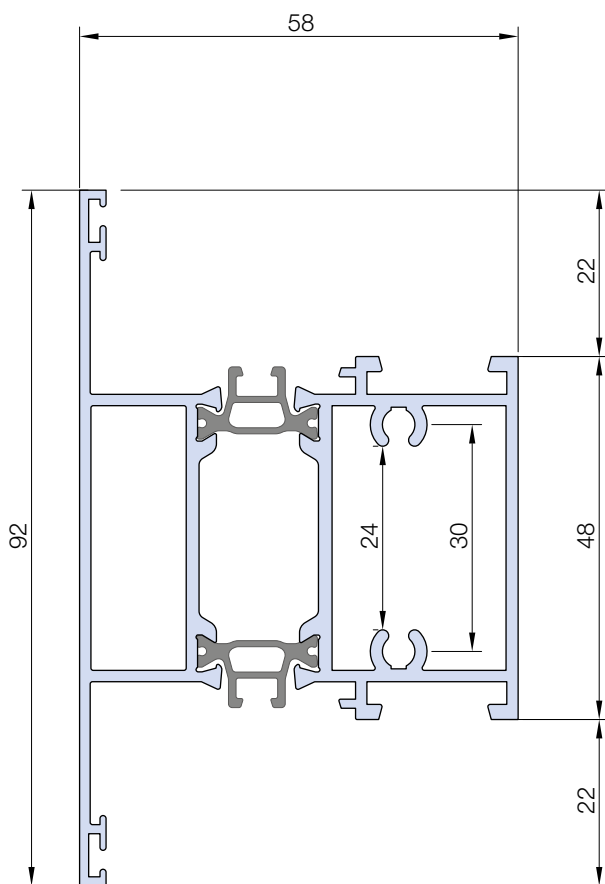

TT 51839

1747 gr/m

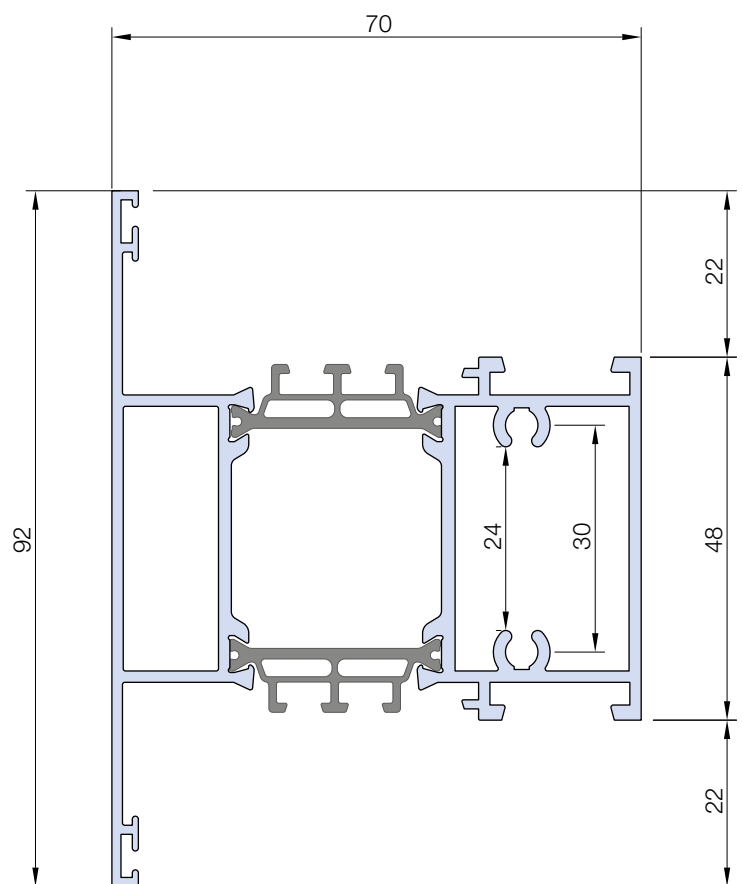

TT 61839

1829 gr/m

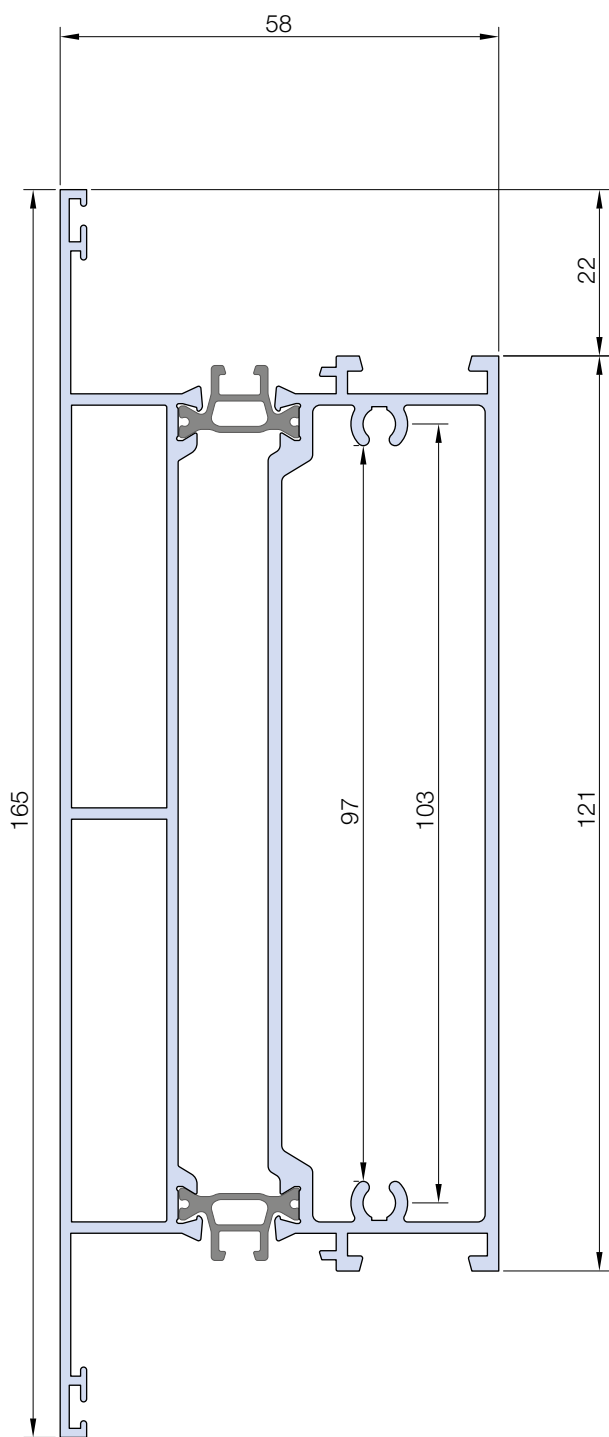

TT 51858
3259 gr/m

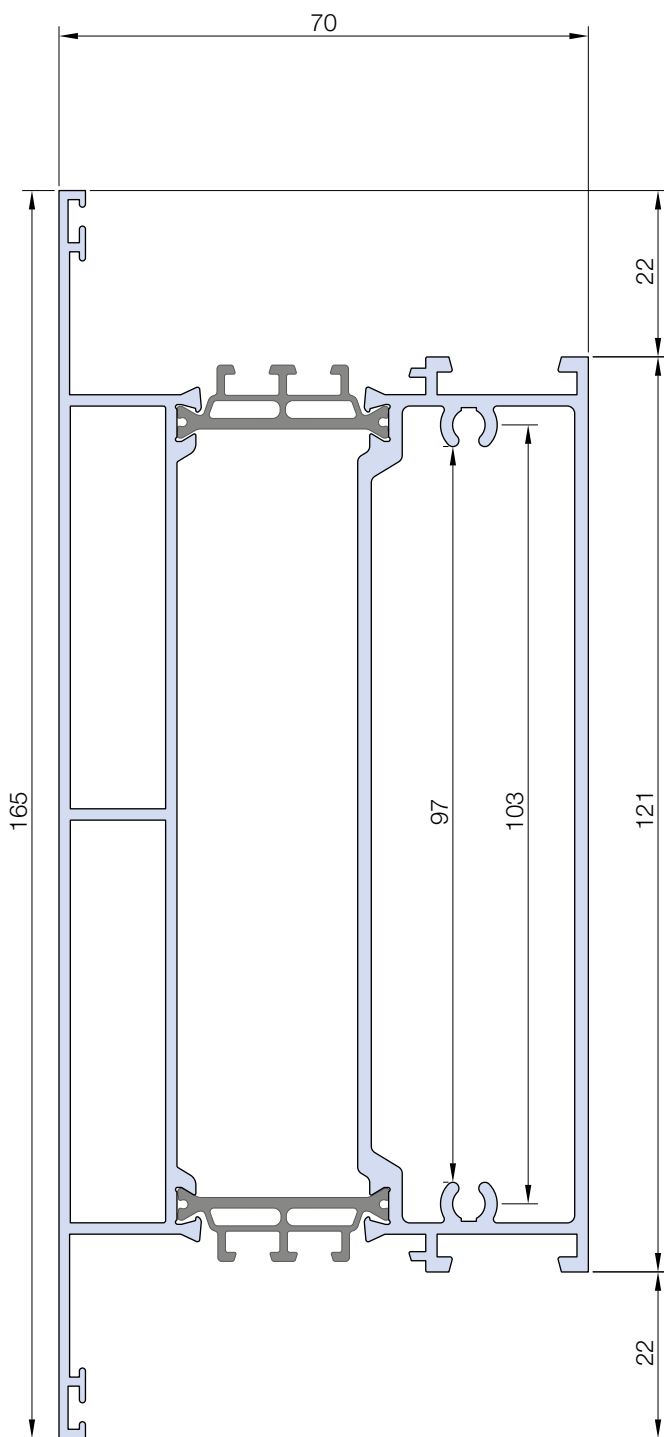

TT 61858
3341 gr/m

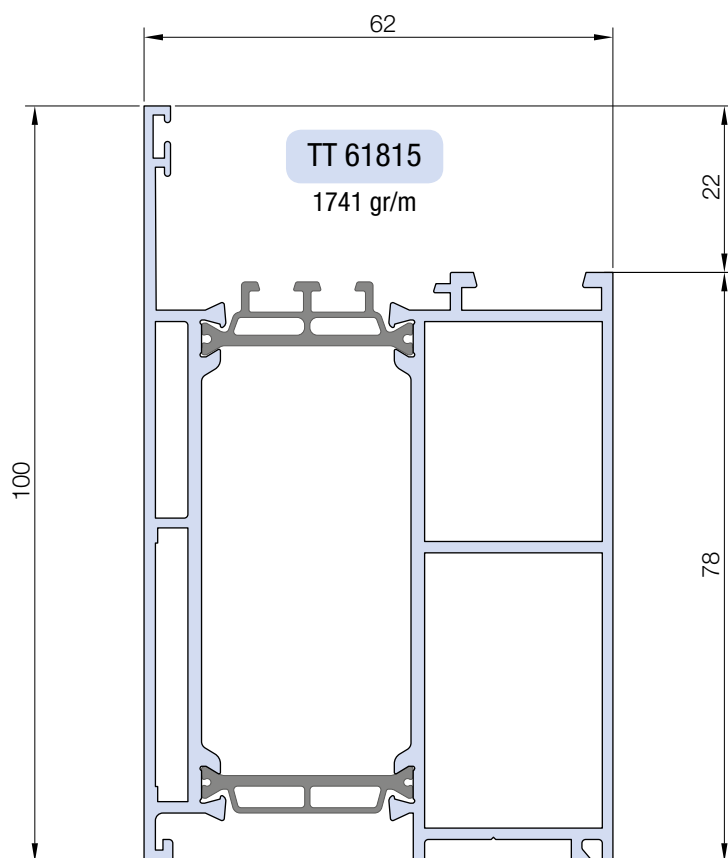
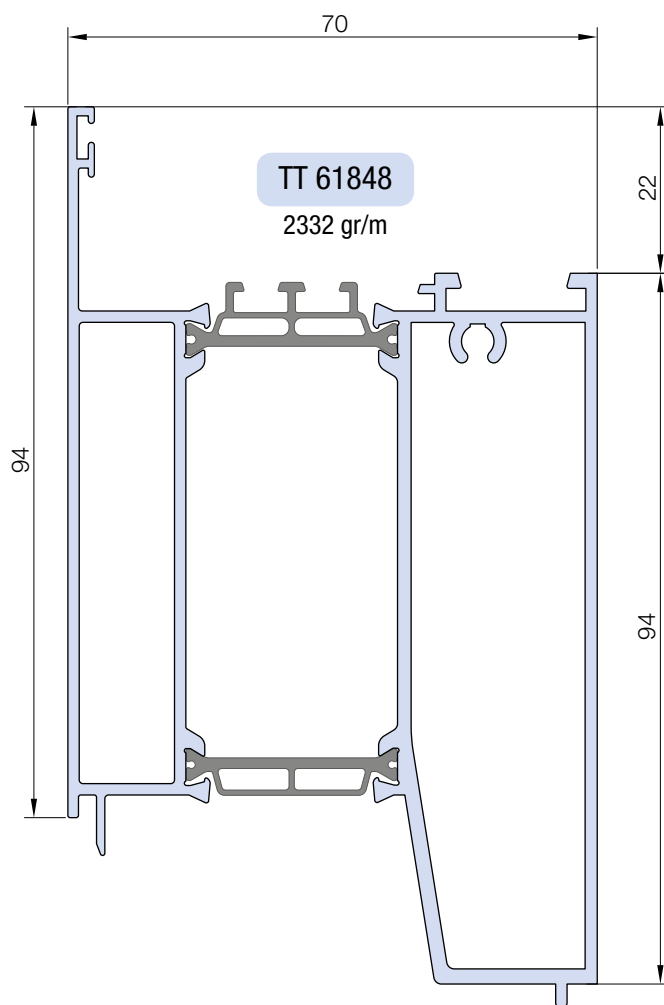
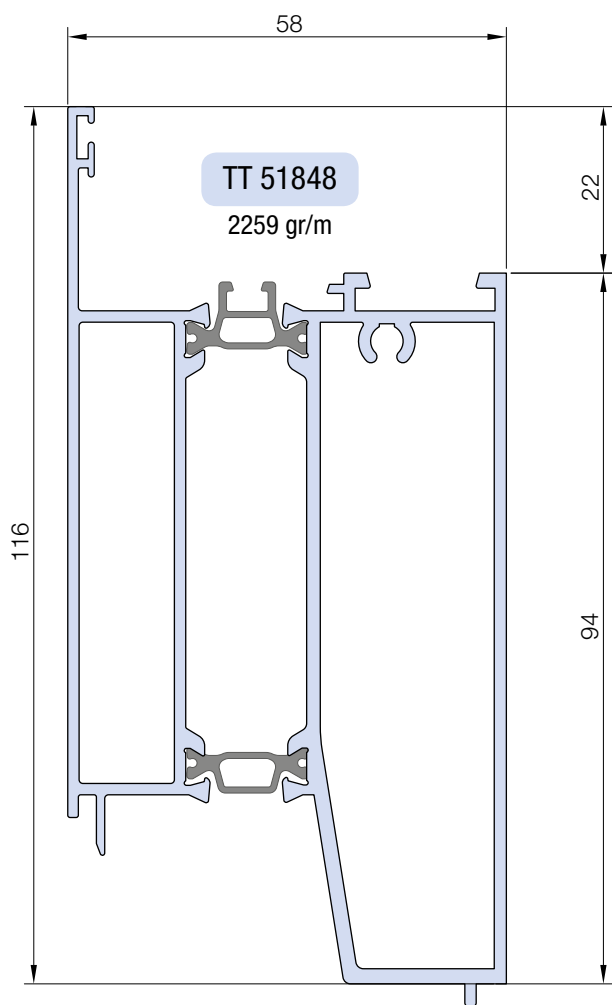

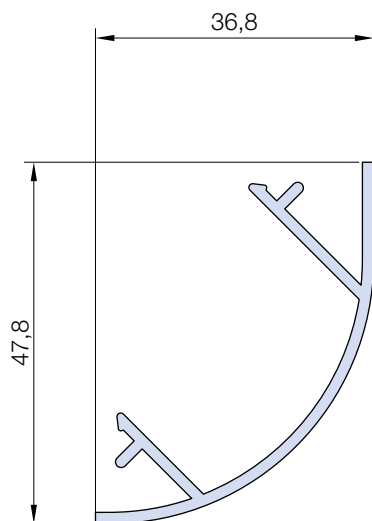

SL 20819

450 gr/m

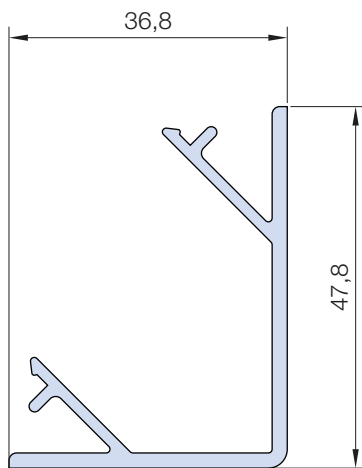

SL 20820

626 g/m

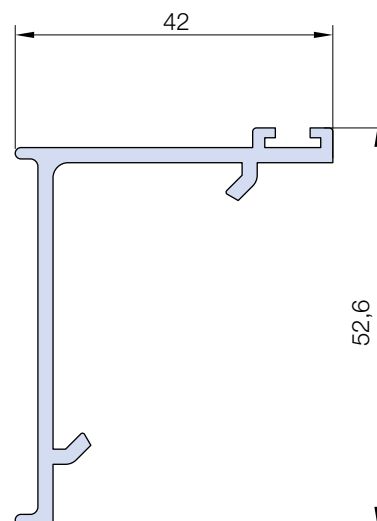

SL 20817

587 gr/m

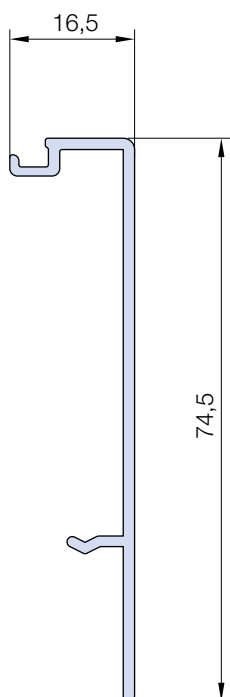

SL 20915

402 gr/m

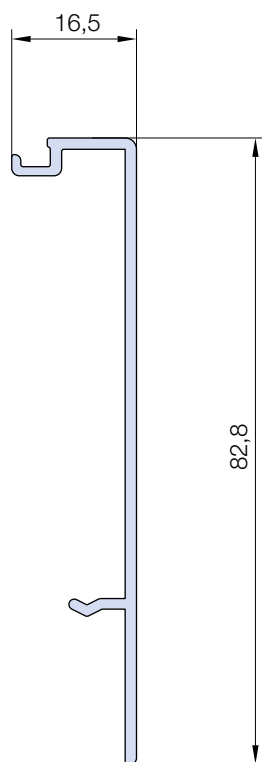

SL 20913

438 gr/m

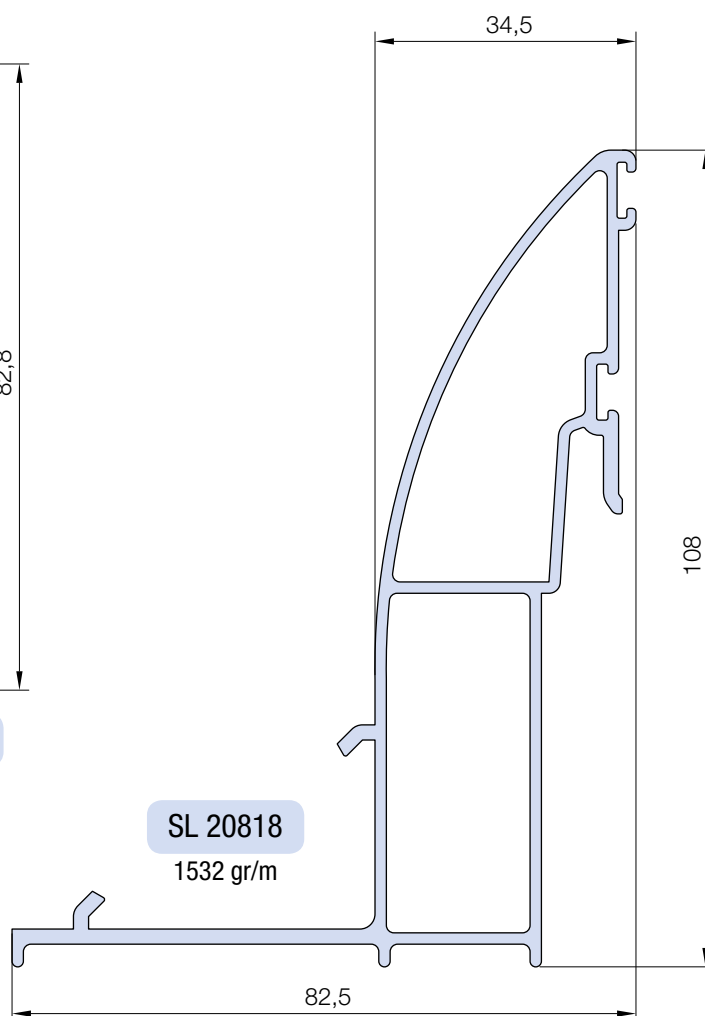

SL 20818

1532 gr/m

**ABBINARE CON
TT 6115**

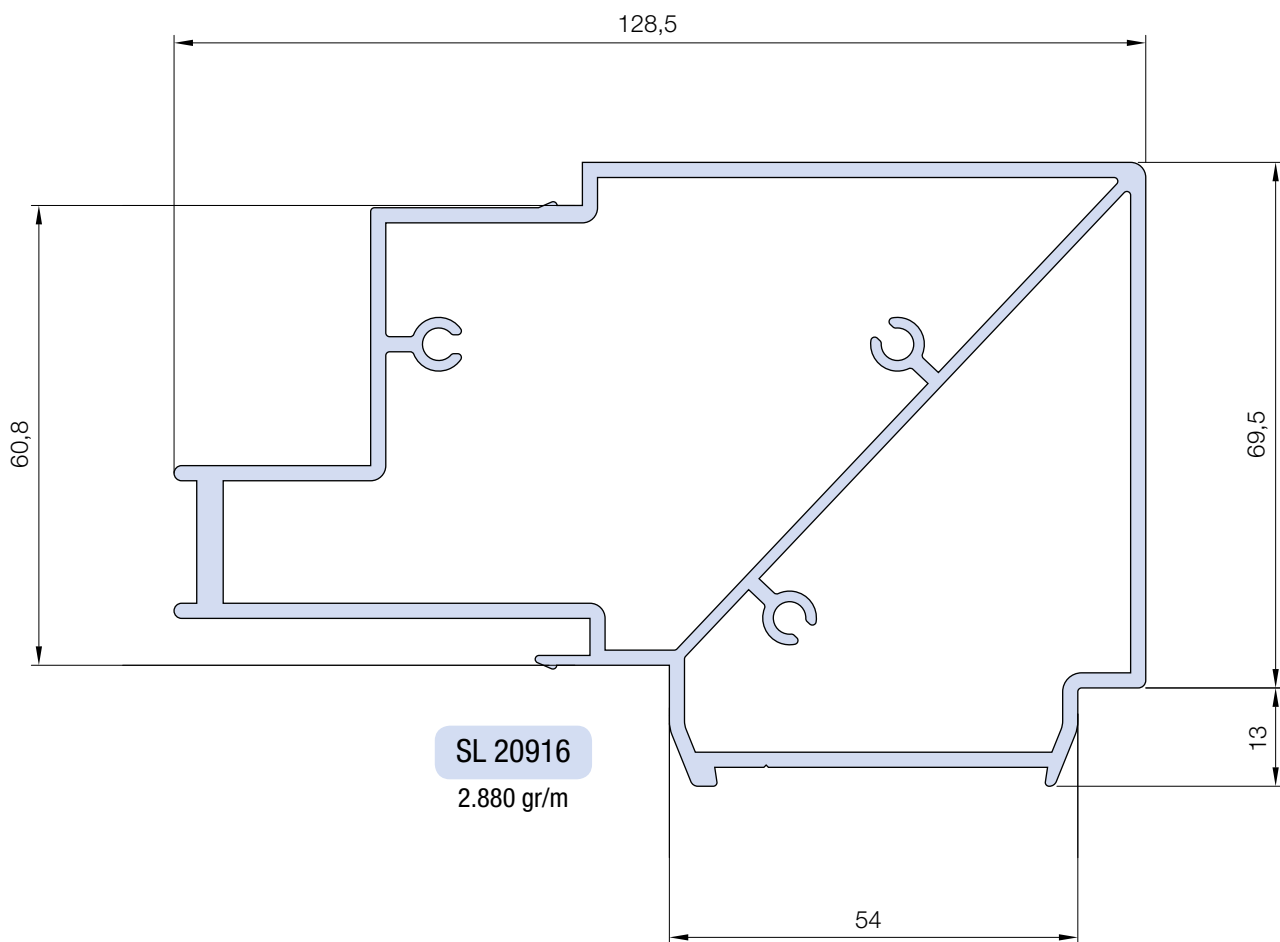

SX 9901
Acciaio inox AISI 316

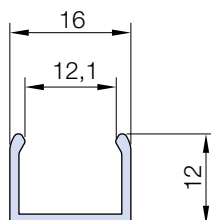

SL 20914
132 gr/m

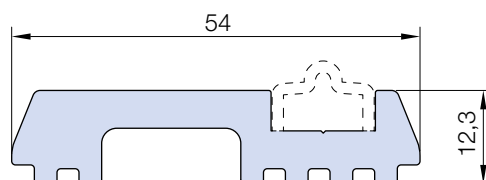

SL 20907
1072 gr/m

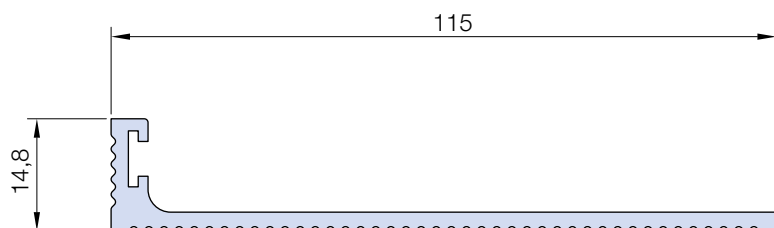

SL 20908
804 gr/m

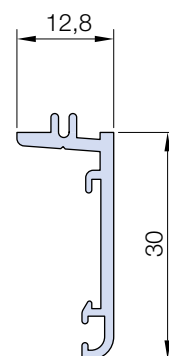

SL 20973
226 gr/m

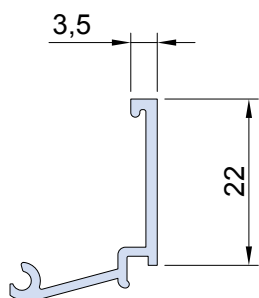

PL 1404*

190 gr/m

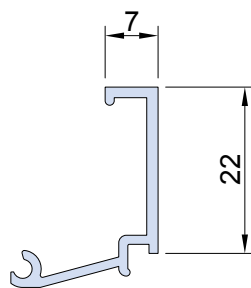

PL 1407*

206 gr/m

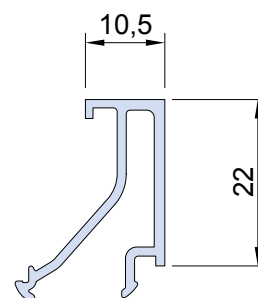

PL 1411

252 gr/m

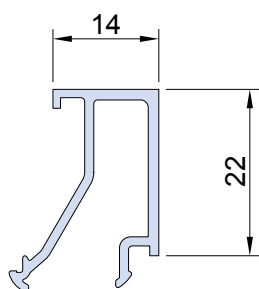

PL 1414

257 gr/m

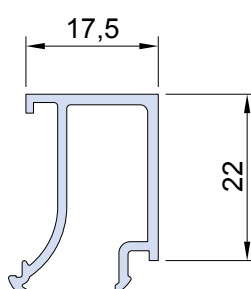

PL 1418

268 gr/m

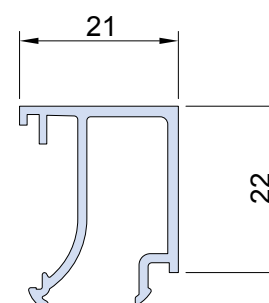

PL 1421

290 gr/m

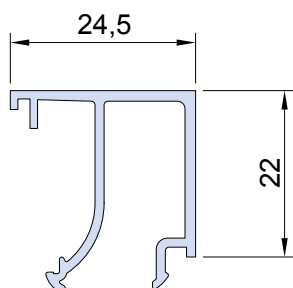

PL 1425

304 gr/m

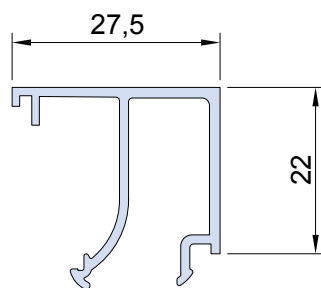

PL 1428

312 gr/m

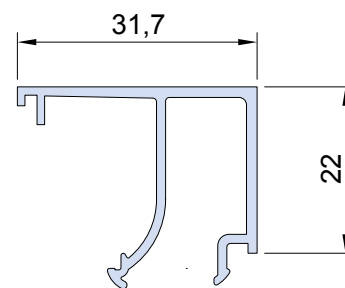

PL 1432

331 gr/m

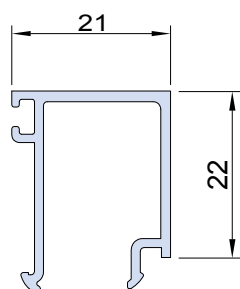

PL 14121

280 gr/m

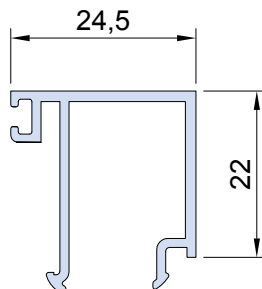

PL 14125

313 gr/m

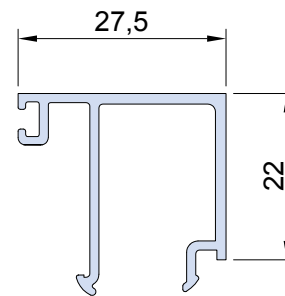

PL 14128

323 gr/m

* UTILIZZARE SEMPRE GOMMINO ACP 5027/ * Use rubber strip ACP 5027 always

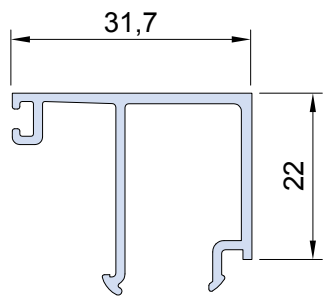

PL 14132

338 gr/m

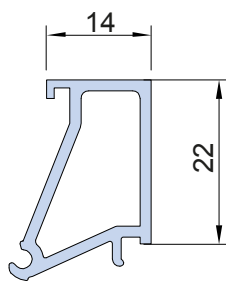

PL 14214*

329 g/m

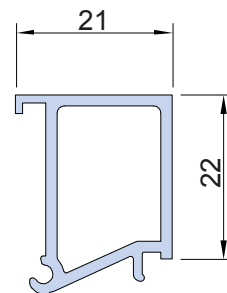

PL 14221*

353 g/m

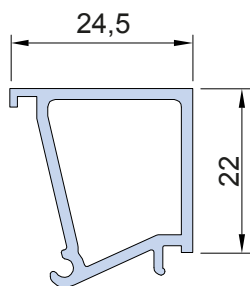

PL 14225*

370 g/m

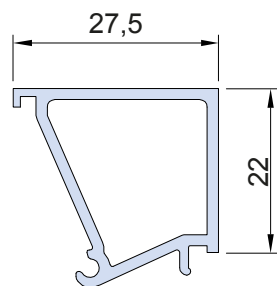

PL 14228*

389 g/m

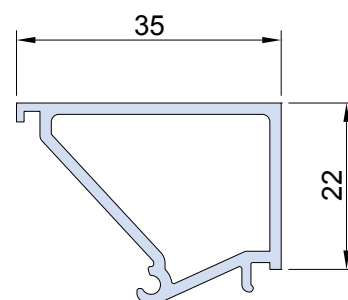

PL 1435*

434 gr/m

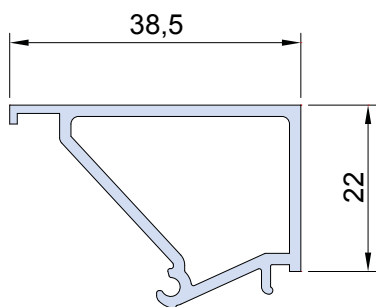

PL 1439*

445 gr/m

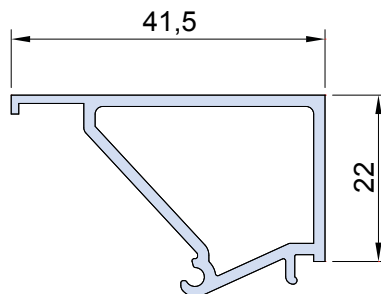

PL 1442*

454 gr/m

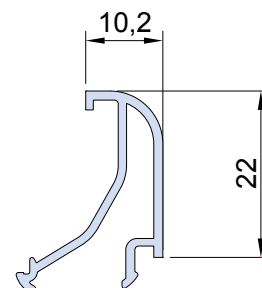

PL 1511

238 gr/m

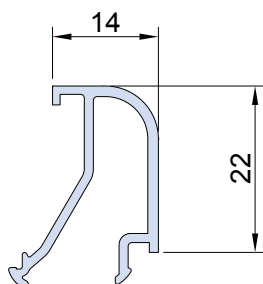

PL 1514

247 gr/m

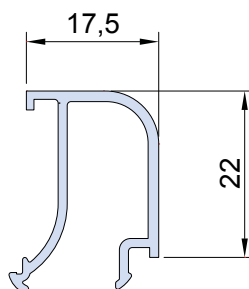

PL 1518

257 gr/m

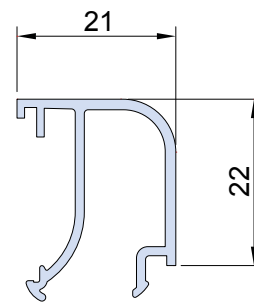

PL 1521

279 gr/m

* UTILIZZARE SEMPRE ACP 5027/ * Use ACP 5027 always

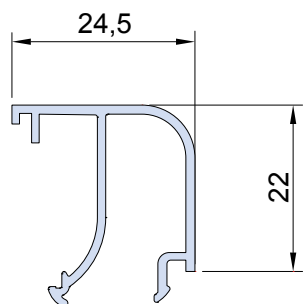

PL 1525

290 gr/m

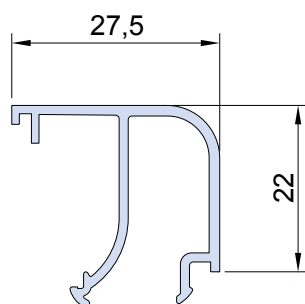

PL 1528

301 gr/m

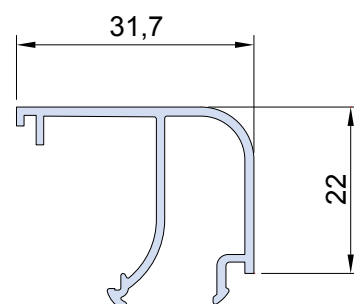

PL 1532

317 gr/m

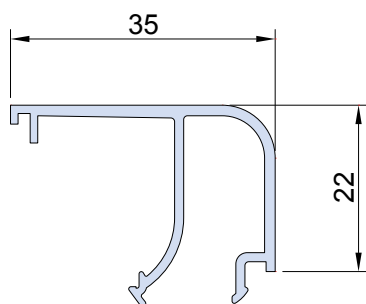

PL 1535

337 gr/m

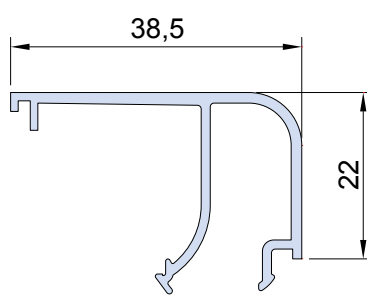

PL 1539

352 gr/m

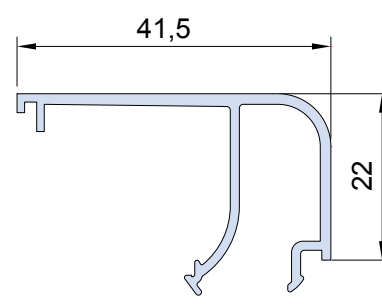

PL 1542

365 gr/m

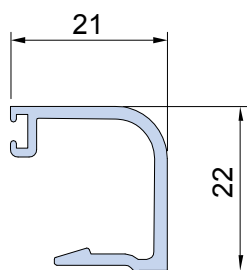

PL 15221*

259 g/m

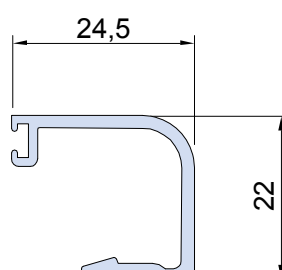

PL 15225*

0,275 g/m

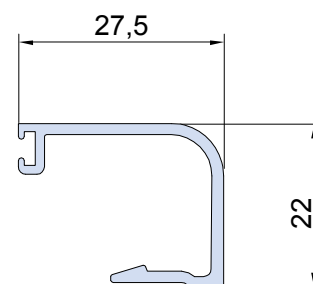

PL 15228*

272 g/m

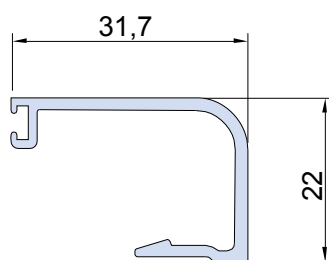

PL 15232*

305 g/m

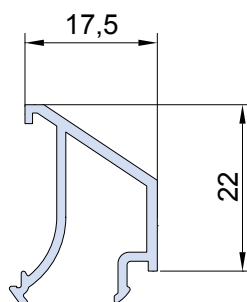

PL 1818

236 gr/m

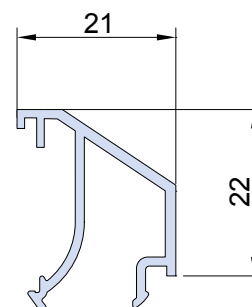

PL 1821

258 gr/m

* UTILIZZARE SEMPRE GOMMINO ACP 5027/ * Use rubber strip ACP 5027 always

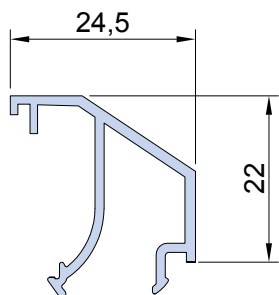

PL 1825
270 gr/m

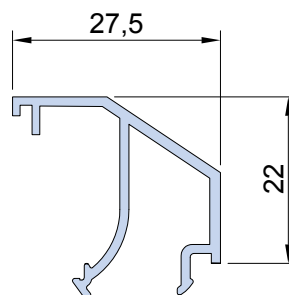

PL 1828
279 gr/m

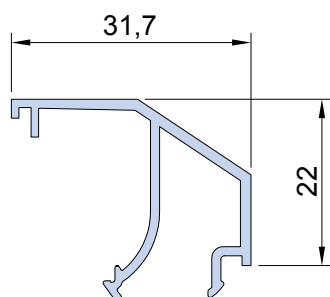

PL 1832
296 gr/m

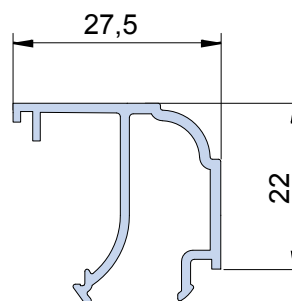

PL 1928
298 gr/m

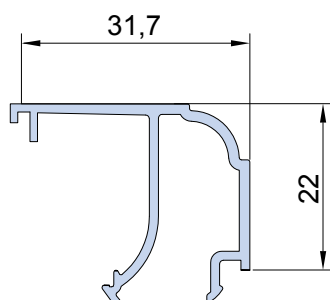

PL 1932
317 gr/m

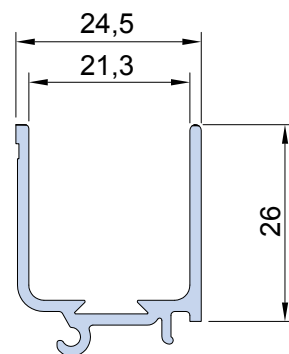



PL 1325*
348 gr/m

* UTILIZZARE SEMPRE ACP 5027/ * Use ACP 5027 always

Fermavetro	Anta TT 90812	Anta TT 90811
<p>PL 1442</p>		
<p>PL 1439</p>		
<p>PL 1435</p>		
<p>PL 1432</p>		
<p>PL 1428</p>		
<p>PL 1425</p>		
<p>PL 1421</p>		
<p>PL 1418</p>		

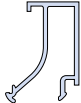
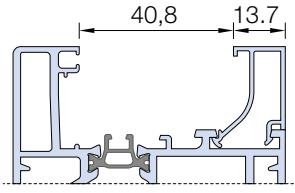
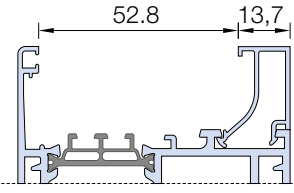
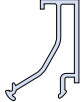
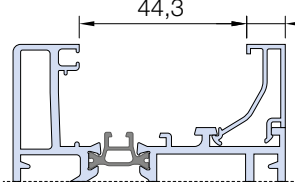
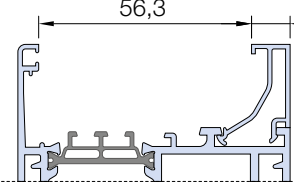
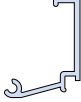
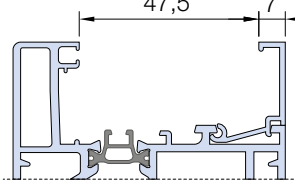
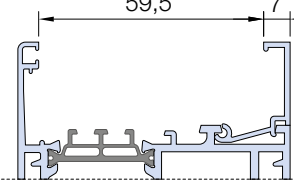
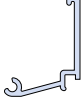
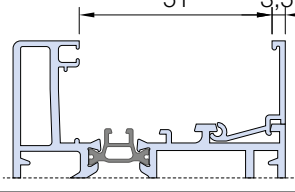
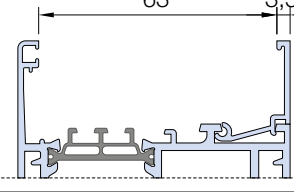
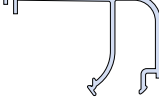
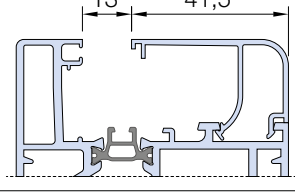
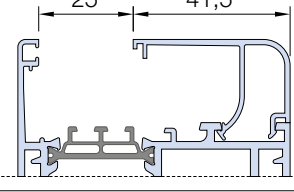
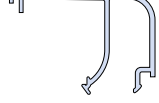
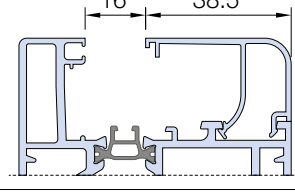
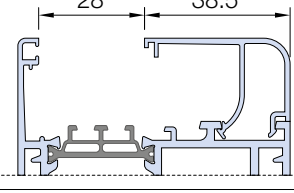

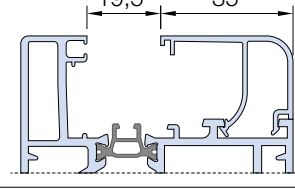
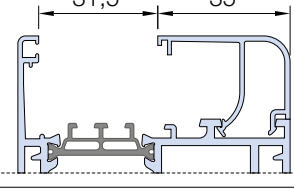
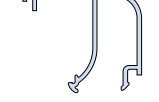
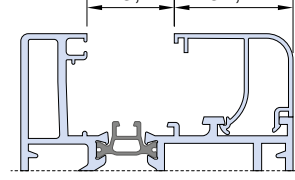
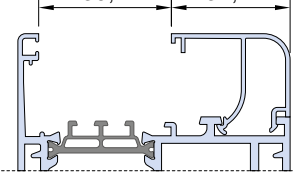
VETRAZIONI
 Design

Fermavetro	Anta TT 90812	Anta TT 90811
 PL 1414	 40,8 13,7	 52,8 13,7
 PL 1411	 44,3 10,2	 56,3 10,2
 PL 1407	 47,5 7	 59,5 7
 PL 1404	 51 3,5	 63 3,5
 PL 1542	 13 41,5	 25 41,5
 PL 1539	 16 38,5	 28 38,5
 PL 1536	 19,5 35	 31,5 35
 PL 1532	 23,1 31,4	 35,1 31,4

VETRAZIONI
 Glazing

Fermavetro	Anta TT 90812	Anta TT 90811
<p>PL 1528</p>	<p>27.3 27.2</p>	<p>38.9 27.2</p>
<p>PL 1525</p>	<p>30.3 24.2</p>	<p>41.9 24.2</p>
<p>PL 1521</p>	<p>33.8 20.7</p>	<p>45.4 20.7</p>
<p>PL 1518</p>	<p>37.3 17.2</p>	<p>48.9 17.2</p>
<p>PL 1514</p>	<p>40.8 13.7</p>	<p>52.3 13.7</p>
<p>PL 1511</p>	<p>44.3 10.2</p>	<p>56.2 10.2</p>
<p>PL 1932</p>	<p>22.8 31.7</p>	<p>34.9 31.7</p>
<p>PL 1928</p>	<p>27 27.5</p>	<p>39 27.5</p>

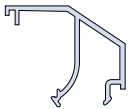
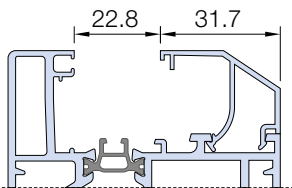
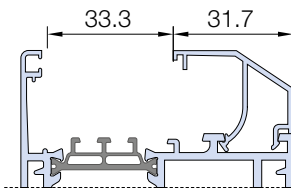
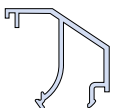
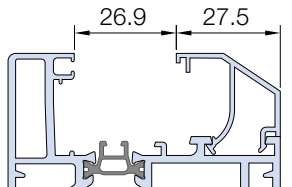
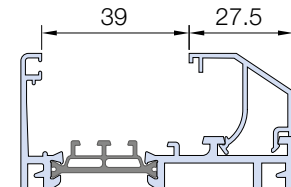
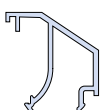
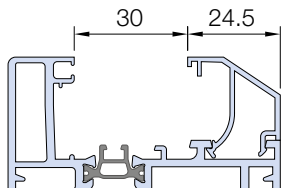
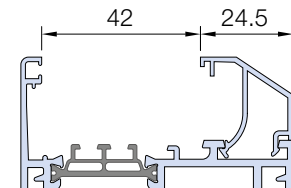
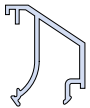
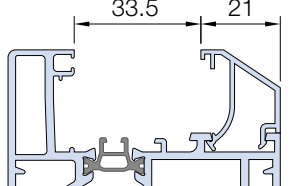
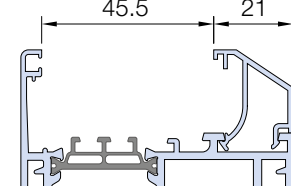
VETRAZIONI
Design

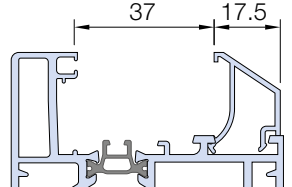
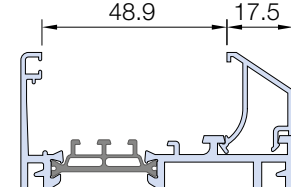
Fermavetro	Anta TT 90812	Anta TT 90811
 <p>PL 1832</p>	 <p>22.8 31.7</p>	 <p>33.3 31.7</p>
 <p>PL 1828</p>	 <p>26.9 27.5</p>	 <p>39 27.5</p>
 <p>PL 1825</p>	 <p>30 24.5</p>	 <p>42 24.5</p>
 <p>PL 1821</p>	 <p>33.5 21</p>	 <p>45.5 21</p>
 <p>PL 1818</p>	 <p>37 17.5</p>	 <p>48.9 17.5</p>

ACP 1000/50	THERMOPOSA Vite TORX testa cilindrica T30 7,5x50 <i>Screw with socket head</i>
ACP 1000/70	THERMOPOSA Vite TORX testa cilindrica T30 7,5x70 <i>Screw with socket head</i>
ACP 1000/80	THERMOPOSA Vite TORX testa cilindrica T30 7,5x80 <i>Screw with socket head</i>
ACP 1000/90	THERMOPOSA Vite TORX testa cilindrica T30 7,5x90 <i>Screw with socket head</i>
ACP 1000/100	THERMOPOSA Vite TORX testa cilindrica T30 7,5x100 <i>Screw with socket head</i>
ACP 1000/110	THERMOPOSA Vite TORX testa cilindrica T30 7,5x110 <i>Screw with socket head</i>
ACP 1000/120	THERMOPOSA Vite TORX testa cilindrica T30 7,5x120 <i>Screw with socket head</i>
ACP 1000/130	THERMOPOSA Vite TORX testa cilindrica T30 7,5x130 <i>Screw with socket head</i>
ACP 1000/150	THERMOPOSA Vite TORX testa cilindrica T30 7,5x150 <i>Screw with socket head</i>
ACP 1000/180	THERMOPOSA Vite TORX testa cilindrica T30 7,5x180 <i>Screw with socket head</i>
ACP 1000/210	THERMOPOSA Vite TORX testa cilindrica T30 7,5x210 <i>Screw with socket head</i>
ACP 1001/50	THERMOPOSA Vite TORX testa svasata T30 7,5x50 <i>Countersunk screw</i>
ACP 1001/70	THERMOPOSA Vite TORX testa svasata T30 7,5x70 <i>Countersunk screw</i>
ACP 1001/80	THERMOPOSA Vite TORX testa svasata T30 7,5x80 <i>Countersunk screw</i>
ACP 1001/90	THERMOPOSA Vite TORX testa svasata T30 7,5x90 <i>Countersunk screw</i>
ACP 1001/100	THERMOPOSA Vite TORX testa svasata T30 7,5x100 <i>Countersunk screw</i>
ACP 1001/110	THERMOPOSA Vite TORX testa svasata T30 7,5x110 <i>Countersunk screw</i>
ACP 1001/120	THERMOPOSA Vite TORX testa svasata T30 7,5x120 <i>Countersunk screw</i>
ACP 1001/130	THERMOPOSA Vite TORX testa svasata T30 7,5x130 <i>Countersunk screw</i>
ACP 1001/150	THERMOPOSA Vite TORX testa svasata T30 7,5x150 <i>Countersunk screw</i>
ACP 1001/180	THERMOPOSA Vite TORX testa svasata T30 7,5x180 <i>Countersunk screw</i>

ACP 1001/210	^{THERMOPOSA} Vite TORX testa svasata T30 7,5x210 <i>Countersunk screw</i>
ACP 5001	Vite Ø8mm per squadrette multifunzione ACP 5801 <i>Screw Ø8mm for multi-function corner cleat ACP 5801</i>
ACP 5008	Squadretta allineamento in acciaio inox <i>Alignment corner joint, stainless steel</i>
ACP 5014	Angolino fermavetro tondo <i>Round glazing bead angle</i>
ACP 5027	Gommino di bloccaggio fermavetro per PL 1404 e P 1407, PL 1439 e PL 1442 <i>Glazing bead locking rubber strip for PL 1404 and PL 1407, PL 1439 and PL 1442</i>
ACP 5030	Spina Ø3mm per squadretta con manico per ACP 50154 <i>Pin.Ø3mm, with grip for ACP 50154 multifunction corner cleat</i>
ACP 5035	Regolo muro in nylon <i>Nylon wall spacer</i>
ACP 5036	Regolo muro in metallo <i>Metal wall spacer</i>
ACP 50110	Squadretta allineamento con eccentrici di tiraggio per ante <i>Alignment corner bracket with tightening eccentrics</i>
ACP 50122	Clip fermavetro <i>Glazing bead clip</i>
ACP 50154	Squadretta multifunzione 4X36mm spinare, cianfrinare e avvitare <i>Multi-purpose bracket 4x36mm broaching-crimping and screwing</i>
ACP 50425	Cavallotto cava fermavetro per inglesine <i>Clamp glazing bead for inglesine</i>
ACP 5521	Cavallotto a pulsante 23X14mm in pressofuso <i>Cross junction 23x14mm, die-cast, with push-button</i>
ACP 5800	Spina per squadretta multifunzione ACP 5801, ACP 5802, ACP 7001 <i>Pin for multifunction corner cleat ACP 5801, ACP 5802, ACP 7001</i>
ACP 5801	Squadretta 23X14mm multifunzione, avvitare, spinare e cianfrinare <i>Multi-purpose bracket 23x14mm, screwing, broaching and crimping</i>
ACP 62130	Appoggio vetro <i>Glass support</i>
ACP 6220	^{THERMOPOSA} Traverso inferiore 20mm Thermopro in PVC <i>Thermopro PVC sill transom, 20mm</i>
ACP 6248/25	^{THERMOPOSA} Controtelaio Thermopro spalla 140mm, battuta 25 rifilabile <i>Thermopro subframe 140mm, beat 25</i>
ACP 6249	^{THERMOPOSA} Traverso inferiore 40mm Thermopro in PVC <i>Thermopro PVC sill transom</i>
ACP 6254	^{THERMOPOSA} Staffe per traverso ACP 6249 <i>Transom bracket for ACP 6249</i>
ACP 6255	^{THERMOPOSA} Zanche per fissaggio del controtelaio ACP 6248(25) <i>Clamps for fixing of subframe for ACP 6248/25</i>

ACP 6256	THERMOPOSA Squadretta angolare per controltaio ACP 6248/25 <i>Corner cleat for ACP 6248/25</i>
ACP 6257	THERMOPOSA Piastra di allineamento per controltaio ACP 6248/25 <i>Alignment plate for ACP 6248/25</i>
ACP 6258	THERMOPOSA Squadretta di rinforzo per controltaio ACP 6248/25 <i>Reinforced bracket for ACP 6248/25</i>
ACP 6259	THERMOPOSA Rinforzo tubolare aperto in acciaio 12x40mm per controltaio ACP 6248/25 <i>Steel tubular reinforcement 12x40mm for ACP 6248/25</i>
ACP 6260	THERMOPOSA Staffe per traverso ACP 6220 <i>Transom bracket for ACP 6220</i>
ACP 8042	Spugna di tenuta per soglia ribassata versione alzante <i>Foam for low threshold, lift&slide type</i>
ACP 8043	Dispositivo arresto anta. Disponibile nei colori bianco, nero e grigio <i>Stop sash. Available white, black and grey</i>
ACP 90101	Maniglione alluminio con vaschetta <i>Handle+recessed handle</i>
ACP 90102	Maniglione + vaschetta in alluminio con foro cilindro sagomato <i>Slide handle+recessed handle with cylinder hole</i>
ACP 90103	Vaschetta in alluminio <i>Recessed handle</i>
ACP 90105	Doppio maniglione in alluminio con foro per cilindro sagomato <i>Double slide handle+cylinder hole</i>
ACP 90112M /898	Asta collegamento carrelli 898mm, anta da 700mm a 1500mm <i>Rollers' connection bar, 898mm</i>
ACP 90112M /1898	Asta collegamento carrelli 1898mm, anta da 1501mm a 2500mm <i>Rollers' connection bar, 1898mm</i>
ACP 90112M /2898	Asta collegamento carrelli 2898mm, anta da 2501mm a 3250mm <i>Rollers' connection bar, 2898mm</i>
ACP 90113M /1785	Asta di comando 1785mm, dim. anta da 1200mm a 1785mm - HM 407mm <i>Control rod, 1785mm</i>
ACP 90113M /2100	Asta di comando 2100mm, dim. anta da 1786mm a 2100mm - HM 1007mm <i>Control rod, 2100mm</i>
ACP 90113M /2400	Asta di comando 2400mm, dim. anta da 2101mm a 2400mm - HM 1007mm <i>Control rod, 2400mm</i>
ACP 90113M /2685	Asta di comando 2685mm, dim. anta da 2401mm a 2700mm - HM 1007mm <i>Control rod, 2685mm</i>
ACP 90114M/P1	Prolunga asta di comando chiusura supplementare, altezza anta fino 3200mm <i>Control rod extension bar with supplementary locking point</i>
ACP 90114M/P2	Prolunga asta di comando, altezza anta fino 3200mm <i>Control rod extension bar</i>
ACP 90115M	Punto di chiusura supplementare per microventilazione 12,5mm <i>Locking point for microventilation, 12,5mm</i>

ACP 90116M/200-	Molla di trazione per asta comando, peso anta < 200Kg <i>Traction spring for control rod, leaf weight < 200Kg</i>
ACP 90116M/200+	Molla di trazione per asta comando, peso anta > 200Kg <i>Traction spring for control rod, leaf weight > 200Kg</i>
ACP 90118M	Kit carrelli 300Kg e spessori asta <i>300Kg roller's with rod shimming blocks</i>
ACP 90118M/R	Carrelli regolabili 300Kg e spessori asta <i>Adjustable 300Kg roller's with rod shimming blocks</i>
ACP 90119M	Punto di chiusura supplementare superiore 12,5mm <i>Locking point, 12,5mm</i>
ACP 90120M	Spessore asta di comando da 20mm <i>Shimming block for control rod 20mm</i>
ACP 90121	Kit antisollevamento <i>Anti-lift kit</i>
ACP 90122	Pistone d'ausilio per meccanismo di sollevamento alzante-scorrevole <i>Comfort lift piston</i>
ACP 90138	Carrelli supplementari, fino a 400Kg <i>Additional roller's, up to 400Kg</i>
ACP 90215	Catenaccio per micro ventilazione <i>Bolt for micro-ventilation</i>
ACP 9028	Cappetta scarico acqua - telaio 2 vie <i>Plug for water drainage - 2ways frames</i>
ACP 9029	Tappi di tenuta per ante frontali <i>Watertight plugs for frontal sash</i>
ACP 9030	Supporto vetro in alluminio estruso <i>Aluminium glass support</i>
ACP 9033M	Kit componenti plastici per 2 ante alzanti <i>Plastic elements for 2-sash</i>
ACP 9034	Cappetta scarico acqua - telaio 3 vie <i>Plug for water drainage - 3ways frames</i>
ACP 9035M	Kit componenti spugnosi per 2 ante alzanti <i>Seal elements for 2-sash</i>
ACP 9036	Distanziale per anta fissa <i>Top/bottom spacer for fixed sash</i>
ACP 9037	Blocchetto antieffrazione <i>Burglary block</i>
ACP 9040	Blocchetto per inserimento coprifuga <i>Frame spacer for fixed+1-rail</i>
ACP 9042	Kit isolamento acustico per raggiungere 40 dB <i>Acoustic insulating elements kit to reach the value 40 dB of noise reduction</i>
ACP 9043M	Kit componenti plastici per anta alzante + fisso <i>Plastic elements for 2-sash - window fix+open</i>

ACP 9044	Tappo per profilo chiusura 90° <i>Plug for profile closure 90°</i>
AGP 4000	Guarnizione di battuta in EPDM <i>EPDM rabbet seal</i>
AGP 4013	Guarnizione esterna in EPDM 2,5mm <i>EPDM external glazing seal 2,5mm</i>
AGP 4014	Guarnizione esterna in EPDM 4mm <i>EPDM external glazing seal 4mm</i>
AGP 40131	Guarnizione sottovetro in polietilene espanso <i>Expanded polystyrene glazing strip</i>
AGP 4103	Guarnizione vetro in EPDM 2.5/3.5 mm per isolamento acustico e termico <i>Internal glass gasket in EPDM 2.5-3.5 mm for sound and thermal insulation</i>
AGP 4106	Guarnizione vetro in EPDM 4/6 mm per isolamento acustico e termico <i>Internal glass gasket in EPDM 4-6 mm for sound and thermal insulation</i>
AGP 4113	Guarnizione vetro esterna in coestruso EPDM/SPUGNA da 2.5 mm per isolamento acustico e termico <i>External glass gasket in co-extruded EPDM/FOAM 2.5 mm for sound and thermal insulation</i>
AGP 4123	Guarnizione vetro esterna in EPDM da 2.5 mm a baffo per siliconare. Garantisce maggiore ermeticità <i>EPDM external glass gasket, 2.5mm Lip sealing strip for applying silicone sealant. Guarantees greater hermetic sealing</i>
AGP 4135	Guarnizione vetro esterna in EPDM da 3.5 mm a baffo per siliconare. Garantisce maggiore ermeticità <i>EPDM external glass gasket, 3.5mm Lip sealing strip for applying silicone sealant. Guarantees greater hermetic sealing</i>
AGP 4203	Guarnizione vetro interna 3 mm filo fermavetro. Consente la piega a 90° <i>3mm, inner glazing bead seal</i>
AGP 4204	Guarnizione vetro interna 4 mm filo fermavetro. Consente la piega a 90° <i>4mm, inner glazing bead seal</i>
AGP 4205	Guarnizione vetro interna 5 mm filo fermavetro. Consente la piega a 90° <i>5mm, inner glazing bead seal</i>
AGP 4206	Guarnizione vetro interna 6 mm filo fermavetro. Consente la piega a 90° <i>6mm, inner glazing bead seal</i>
AGP 5025	^{THERMOPOSA} Adesivo High Tack a base di MS polimero ad effetto ventosa bianco <i>High Tack MS Polymer adhesive sealant with suction effect - white</i>
AGP 5030/I	^{THERMOPOSA} Profilo portaintonaco per esterno con asole 250cm <i>Outdoor plaster profile</i>
AGP 5031	^{THERMOPOSA} Profilo portaintonaco per interno con asole 250cm <i>Inner plaster profile</i>
AGP 5032	^{THERMOPOSA} Barriera al vapore per controtelaio ACP 6246 <i>Vapor barrier for ACP 6246</i>
AGP 5033	^{THERMOPOSA} Nastro precompresso BG1 da 15mm per sigillatura della battuta <i>BG1 beat sealing, 15mm</i>
AGP 5034/725	^{THERMOPOSA} Nastro precompresso per posa in battuta per la sigillatura della spalla <i>Band for laying batting, wall sealing</i>
AGP 5035/...	^{THERMOPOSA} Sigillante MS Polimero bianco, marrone, grigio o nero, 290 ml <i>MS Polymer sealant</i>

AGP 5036	^{THERMOPOSA} Schiuma poliuretana elastica fissaggio controtelaio ACP 6246 <i>Elastic polyurethane foam for ACP 6246</i>
AGP 5037	^{THERMOPOSA} Nastro in schiuma di PVC per soglia e traverso inferiore <i>PVC foam band for transom and threshold</i>
AGP 6280	Guarnizione di giunzione telaio battente-telaio scorrevole <i>Side-hung frame/sliding frame interface seal</i>
AGP 7007	Guarnizione vetro esterna da 3 mm, filo alluminio, consente la piega a 90° senza taglio <i>External glazing seal, 3 mm, installed flush with aluminum. Can be bent at a 90° angle without cutting</i>
AGP 8005	Spazzolino con lamella in tessuto. Conf. metri: 100 <i>Door bottom seal brush. Mt: 100</i>
AGP 9005	Guarnizione di battuta in espanso rivestito 6,9x9,5 colore grigio, marrone e nero <i>Rebate gasket for lift&slide system / Brown, gray and black</i>
SA 2902 NG	Tassello per spessore tamponamento da 2mm, da abbinare ad ACP 9030 <i>Setting block for infill shimming of 2mm</i>
SA 2903 NR	Tassello per spessore tamponamento da 3mm, da abbinare ad ACP 9030 <i>Setting block for infill shimming of 3mm</i>
SA 2904 NB	Tassello per spessore tamponamento da 4mm, da abbinare ad ACP 9030 <i>Setting block for infill shimming of 4mm</i>
SA 2905 NN	Tassello per spessore tamponamento da 5mm, da abbinare ad ACP 9030 <i>Setting block for infill shimming of 5mm</i>
TAC 804	Profilo chicane ridotto in pvc barre da 3m <i>PVC profile for central rebate, bar of 3m</i>
TAC 903	Profilo chicane con viti a scomparsa <i>Chicane profile</i>

ELENCO GUARNIZIONI

	<p>AGP 4000</p> <p>Guarnizione di battuta in EPDM Cfz: 400m</p> <p><i>EPDM rabbet seal Pkg: 400m</i></p>		<p>AGP 4123</p> <p>Guarnizione vetro esterna in EPDM da 2.5mm a baffo per siliconare. Garantisce maggiore ermeticità Cfz: 150m</p> <p><i>EPDM external glass gasket, 2.5mm Lip sealing strip for applying silicone sealant. Guarantees greater hermetic sealing Pkg: 150m</i></p>
	<p>AGP 6280</p> <p>Guarnizione di giunzione telaio battente-telaio scorrevole Cfz: 300m</p> <p><i>Side-hung frame/sliding frame interface seal Pkg: 300m</i></p>		<p>AGP 4135</p> <p>Guarnizione vetro esterna in EPDM da 3,5mm a baffo per siliconare. Garantisce maggiore ermeticità Cfz: 150m</p> <p><i>EPDM external glass gasket, 3.5mm. Lip sealing strip for applying silicone sealant. Guarantees greater hermetic sealing Pkg: 150m</i></p>
	<p>AGP 4014</p> <p>Guarnizione esterna in EPDM 4mm Cfz: 200m</p> <p><i>EPDM external glazing seal 4mm Pkg: 200m</i></p>		<p>AGP 7007</p> <p>Guarnizione vetro esterna da 3 mm, filo alluminio, consente la piega a 90° senza taglio Cfz: 500m</p> <p><i>External glazing seal, 3 mm, installed flush with aluminum. Can be bent at a 90° angle without cutting Pkg: 500m</i></p>
	<p>AGP 4013</p> <p>Guarnizione esterna in EPDM 2,5mm Cfz: 200m</p> <p><i>EPDM external glazing seal 2,5mm Pkg: 200m</i></p>		<p>AGP 4103</p> <p>Guarnizione vetro in EPDM 2,5/3,5mm per isolamento acustico e termico Cfz: 100m</p> <p><i>Internal glass gasket in EPDM 2.5-3.5mm for sound and thermal insulation Pkg: 100m</i></p>
	<p>AGP 4113</p> <p>Guarnizione vetro esterna in coestruso EPDM/SPUGNA da 2,5mm per isolamento acustico e termico Cfz: 100m</p> <p><i>External glass glazing co-extruded EPDM/FOAM 2.5mm for sound and thermal insulation Pkg: 100m</i></p>		<p>AGP 4106</p> <p>Guarnizione vetro in EPDM 4/6mm per isolamento acustico e termico Cfz: 80m</p> <p><i>Internal glass gasket in EPDM 4-6mm for sound and thermal insulation Pkg: 80m</i></p>

	AGP 4203
	<p>Guarnizione vetro interna 3mm filo fermavetro. Consente la piega a 90° Cfz: 200m</p> <p><i>3mm, inner glazing bead seal Pkg: 200m</i></p>

	AGP 8005
	<p>Spazzolino con lamella in tessuto Cfz: 100m</p> <p><i>Door bottom seal brush Pkg: 100m</i></p>

	AGP 4204
	<p>Guarnizione vetro interna 4mm filo fermavetro. Consente la piega a 90° Cfz: 150m</p> <p><i>4mm, inner glazing bead seal Pkg: 150m</i></p>

	AGP 9005
	<p>Guarnizione di battuta in espanso rivestito 6,9x9,5 colore grigio, marrone e nero Cfz: 100m</p> <p><i>Rebate gasket for lift&slide system / Brown, gray and black Pkg: 100m</i></p>

	AGP 4205
	<p>Guarnizione vetro interna 5mm filo fermavetro. Consente la piega a 90° Cfz: 120m</p> <p><i>5mm, inner glazing bead seal Pkg: 120m</i></p>

	TAC 804
	<p>Profilo chicane ridotta per anta TT90822 Cfz: 3m</p> <p><i>Profile for central rebate for sash TT 90822 Pkg: 3m</i></p>

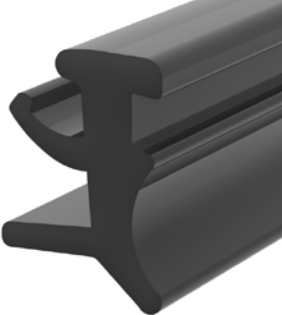





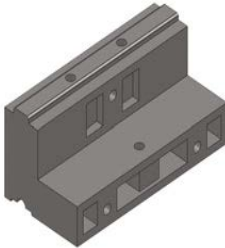

	AGP 4206
	<p>Guarnizione vetro interna 6mm filo fermavetro. Consente la piega a 90° Cfz: 100m</p> <p><i>6mm, inner glazing bead seal Pkg: 100m</i></p>

	TAC 903
	<p>Profilo chicane con viti a scomparsa Cfz: 3m</p> <p><i>Chicane profile Pkg: 3m</i></p>

	AGP 40131
	<p>Guarnizione sottovetro in polietilene espanso di 11x30mm Cfz: 100m</p> <p><i>Expanded polystyrene glazing strip Pkg: 100m</i></p>

	ACP 50122
	<p>Clip nylon per fermavetro inserimento frontale Cfz: 1000m</p> <p><i>Nylon clip for glazing bead Pkg: 1000m</i></p>

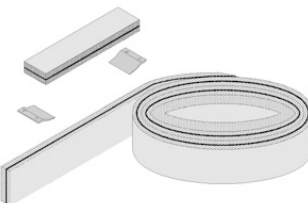
ELENCO ACCESSORI GENERICI

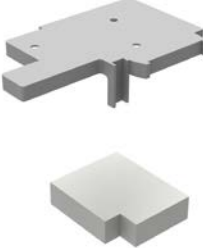
	<p align="center">ACP 5014</p> <p>Angolino fermavetro tondo Cfz: 160pz</p> <p><i>Round glazing bead angle Pkg: 160pcs</i></p>		<p align="center">ACP 9036</p> <p>Distanziale per anta fissa Cfz: 40pz</p> <p><i>Top/bottom spacer for fixed sash Pkg: 40pcs</i></p>
	<p align="center">ACP 5027</p> <p>Gommino di bloccaggio fermavetro per PL 1404 e P 1407, PL 1439 e PL 1442 Cfz: 100pz</p> <p><i>Gleazing bead locking rubber strip for PL 1404 and PL 1407, PL 1439 and PL 1442 Pkg: 100pcs</i></p>		<p align="center">ACP 9037</p> <p>Blocchetto antisollevamento Cfz: 100pz</p> <p><i>Burglary block Pkg: 100pcs</i></p>
	<p align="center">ACP 5035</p> <p>Regolo muro in nylon Cfz: 100pz</p> <p><i>Nylon wall spacer Pkg: 100pcs</i></p>		<p align="center">ACP 9040</p> <p>Blocchetto per inserimento coprifuga Cfz: 400pz</p> <p><i>Frame spacer for fixed+1-rail Pkg: 400pcs</i></p>
	<p align="center">ACP 5036</p> <p>Regolo muro in metallo Cfz: 100pz</p> <p><i>Metal wall spacer Pkg: 100pcs</i></p>		<p align="center">ACP 9042</p> <p>Kit isolamento acustico per raggiungere 40 dB Cfz: 1kit, disponibile solo su ordinazione</p> <p><i>Acoustic insulating elements kit to reach the value 40 dB of noise reduction Pkg: 1kit</i></p>
	<p align="center">ACP 9029</p> <p>Tappi di tenuta per TT 9014 Cfz: 20pz</p> <p><i>Watertight plugs for TT 9014 Pkg: 20pcs</i></p>		<p align="center">ACP 9044</p> <p>Kit tappi per profilo SL 20916 chiusura 90° Cfz: 1kit, disponibile solo su ordinazione</p> <p><i>Plug for profile SL 20916 closure 90° Pkg: 1kit</i></p>

	ACP 62130
	<p>Appoggio vetro Cfz: 100pz</p> <p><i>Glass support Pkg: 100pcs</i></p>

	SA 2905NN
	<p>Tassello per spessore tamponamento da 5mm, da abbinare ad ACP 9030 Cfz: 100pz</p> <p><i>Setting block for infill shimming of 5mm Pkg: 100pcs</i></p>

	ACP 9030
	<p>Supporto vetro in alluminio estruso Cfz: 200pz</p> <p><i>Aluminum glass support Pkg: 200pcs</i></p>

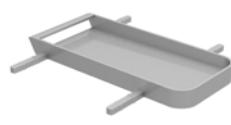
	ACP 9028
	<p>Cappetta scarico acqua - telaio 2 vie Cfz: 100pz</p> <p><i>Plug for water drainage - 2ways frames Pkg: 100pcs</i></p>

	SA 2902NG
	<p>Tassello per spessore tamponamento da 2mm, da abbinare ad ACP 9030 Cfz: 100pz</p> <p><i>Setting block for infill shimming of 2mm Pkg: 100pcs</i></p>

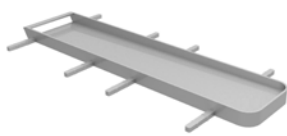
	ACP 9034
	<p>Cappetta scarico acqua - telaio 3 vie Cfz: 40pz</p> <p><i>Plug for water drainage - 3ways frames Pkg: 40pcs</i></p>

	SA 2903NR
	<p>Tassello per spessore tamponamento da 3mm, da abbinare ad ACP 9030 Cfz: 100pz</p> <p><i>Setting block for infill shimming of 3mm Pkg: 100pcs</i></p>





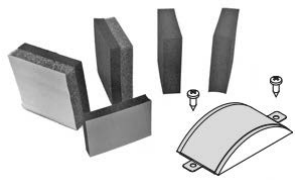





	ACP 8042
	<p>Spugna di tenuta per soglia ribassata versione alzante Cfz: 5pz</p> <p><i>Foam for low threshold, lift&slide type Pkg: 5pcs</i></p>

	SA 2904NB
	<p>Tassello per spessore tamponamento da 4mm, da abbinare ad ACP 9030 Cfz: 100pz</p> <p><i>Setting block for infill shimming of 4mm Pkg: 100pcs</i></p>

	ACP 9035M
	<p>Kit componenti spugnosi per 2 ante alzanti Cfz: 1kit</p> <p><i>Seal elements for 2-sash Pkg: 1kit</i></p>











ACCESSORI
Fittings

ELENCO ACCESSORI DI GIUNZIONE

ACP 9033M	
 x 1 pz.	Kit componenti plastici per 2 ante alzanti Cfz: 1kit <i>Plastic elements for 2-sash</i> <i>Pkg: 1kit</i>
 x 1 pz.	
 x 1 pz.	
 x 1 pz.	
 x 4 pz.	
 x 2 + 2 pz.	
 x 16 pz.	
 x 4 pz.	
 x 4 pz.	
 x 8 pz.	

ACP 5001	
	Vite Ø8mm per squadrette multifunzione ACP 5801 Cfz: 1000pz <i>Screw Ø8mm for multi-function corner cleat ACP 5801</i> <i>Pkg: 1000pcs</i>

ACP 5008	
	Squadretta allineamento in acciaio inox Cfz: 400pz <i>Alignment corner joint, stainless steel</i> <i>Pkg: 400pcs</i>









ACP 9043M	
 x 1 pz.	Kit componenti plastici per anta alzante + fisso Cfz: 1kit <i>Plastic elements for 2-sash - window fix+open</i> <i>Pkg: 1kit</i>
 x 1 pz.	
 x 1 pz.	
 x 1 pz.	
 x 2 pz.	
 x 1 + 1 pz.	
 x 8 pz.	
 x 2 pz.	
 x 2 pz.	
 x 4 pz.	

ACP 50110	
	Squadretta allineamento con eccentrici di tiraggio per ante Cfz: 250pz <i>Alignment corner bracket with tightening eccentrics</i> <i>Pkg: 250pcs</i>

ACP 50154	
	Squadretta multifunzione 4X36mm spinare, cianfrinare e avvitare Cfz: 200pz <i>Multi-purpose bracket 4x36mm broaching-crimping and screwing</i> <i>Pkg: 200pcs</i>

ACP 5030	
	Spina Ø3mm per squadretta con manico per ACP 50154 Cfz: 400pz <i>Pin. Ø3mm, with grip for ACP 50154 multifunction corner cleat</i> <i>Pkg: 400pcs</i>

ELENCO ACCESSORI DI CHIUSURA

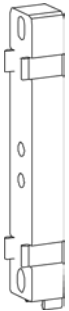
	<p>ACP 50425</p> <p>Cavallotto cava fermavetro per inglesine Cfz: 250pz</p> <p><i>Clamp glazing bead for inglesine Pkg: 250pcs</i></p>		<p>ACP 90101</p> <p>Maniglione alluminio con vaschetta Cfz: 1pz</p> <p><i>Handle+recessed handle Pkg: 1pcs</i></p>
	<p>ACP 5521</p> <p>Cavallotto a pulsante 23X14mm in pressofuso Cfz: 250pz</p> <p><i>Cross junction 23x14mm, die-cast, with push-button Pkg: 250pcs</i></p>		<p>ACP 90102</p> <p>Maniglione + vaschetta in alluminio con foro cilindro sagomato Cfz: 1pz</p> <p><i>Slide handle+recessed handle with cylinder hole Pkg: 1pcs</i></p>
	<p>ACP 5800</p> <p>Spina per squadretta multifunzione ACP 5801 Cfz: 1000pz</p> <p><i>Pin for multifunction corner cleat ACP 5801 Pkg: 1000pcs</i></p>		<p>ACP 90103</p> <p>Vaschetta in alluminio Cfz: 5pz</p> <p><i>Recessed handle Pkg: 5pcs</i></p>
	<p>ACP 5801</p> <p>Squadretta 23X14mm multifunzione, avvitare, spinare e cianfrinare Cfz: 200pz</p> <p><i>Multi-purpose bracket 23x14mm, screwing, broaching and crimping Pkg: 200pcs</i></p>		<p>ACP 90105</p> <p>Maniglione doppio per cilindro sagomato Cfz: 1pz</p> <p><i>Double slide handle+cylinder hole Pkg: 1pcs</i></p>
	<p>ACP 90120M</p> <p>Spessore asta di comando da 20mm Cfz: 50pz</p> <p><i>Shimming block for control rod 20mm Pkg: 50pcs</i></p>		

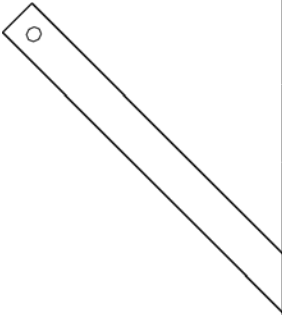
	<p>ACP 90112M/898</p> <p>Asta collegamento carrelli 898mm, anta da 700mm a 1500mm Cfz: 1pz</p> <p><i>Rollers' connection bar, 898mm Pkg: 1pcs</i></p>
	<p>ACP 90112M/1898</p> <p>Asta collegamento carrelli 1898mm, anta da 1501mm a 2500mm Cfz: 1pz</p> <p><i>Rollers' connection bar, 1898mm Pkg: 1pcs</i></p>
	<p>ACP 90112M/2898</p> <p>Asta collegamento carrelli 2898mm, anta da 2501mm a 3250mm Cfz: 1pz</p> <p><i>Rollers' connection bar, 2898mm Pkg: 1pcs</i></p>

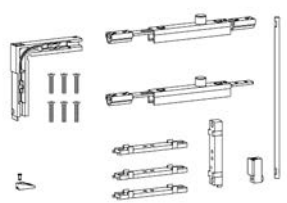
	<p>ACP 90121</p> <p>Kit antisollevamento Cfz: 1pz</p> <p><i>Anti-lift kit Pkg: 1pcs</i></p>
--	--

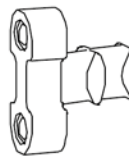
	<p>ACP 90115M</p> <p>Punto di chiusura supplementare per microventilazione 12,5mm Cfz: 10pz</p> <p><i>Locking point for microventilation, 12,5mm Pkg: 10pcs</i></p>
--	--

	<p>ACP 90119M</p> <p>Punto di chiusura supplementare superiore 12,5mm Cfz: 10pz</p> <p><i>Locking point, 12,5mm Pkg: 10pcs</i></p>
--	---

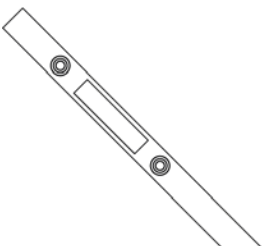
	<p>ACP 90114M/P1</p> <p>Prolunga asta di comando con punto di chiusura supplementare, altezza anta fino 3200mm Cfz: 1pz</p> <p><i>Control rod extension bar with supplementary locking point Pkg: 1pcs</i></p>
---	---

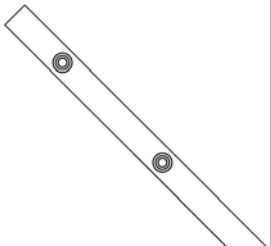
	<p>ACP 90114M/P2</p> <p>Prolunga asta di comando, altezza anta fino 3200mm Cfz: 1pz</p> <p><i>Control rod extension bar Pkg: 1pcs</i></p>
---	--

	<p>ACP 90116M/200-</p> <p>Molla di trazione per asta comando, peso anta < 200Kg Cfz: 1pz</p> <p><i>Traction spring for control rod, leaf weight < 200Kg Pkg: 5pcs</i></p>
--	--

	<p>ACP 90116M/200+</p> <p>Molla di trazione per asta comando, peso anta > 200Kg Cfz: 1pz</p> <p><i>Traction spring for control rod, leaf weight > 200Kg Pkg: 1pcs</i></p>
--	--

	<p>ACP 90113M /1785</p> <p>Asta di comando 1785mm, dim. anta da 1200mm a 1785mm - HM 407mm Cfz: 1pz</p> <p><i>Control rod, 1785mm Pkg: 1pcs</i></p>
	<p>ACP 90113M /2100</p> <p>Asta di comando 2100mm, dim. anta da 1786mm a 2100mm - HM 1007mm Cfz: 1pz</p> <p><i>Control rod, 2100mm Pkg: 1pcs</i></p>
	<p>ACP 90113M /2400</p> <p>Asta di comando 2400mm, dim. anta da 2101mm a 2400mm - HM 1007mm Cfz: 1pz</p> <p><i>Control rod, 2400mm Pkg: 1pcs</i></p>
	<p>ACP 90113M /2685</p> <p>Asta di comando 2685mm, dim. anta da 2401mm a 2700mm - HM 1007mm Cfz: 1pz</p> <p><i>Control rod, 2685mm Pkg: 1pcs</i></p>

	<p>ACP 90122</p> <p>Pistone d'ausilio per meccanismo di sollevamento alzante-scorrevole Cfz: 1pz</p> <p><i>Comfort lift piston Pkg: 1pcs</i></p>
--	---

	<p>ACP 90118M</p> <p>Kit carrelli 300Kg e spessori asta Cfz: 1kit</p> <p><i>300Kg roller's with rod shimming blocks Pkg: 1kit</i></p>
--	--









	<p>ACP 90118M/R</p> <p>Kit carrelli regolabili 300Kg e spessori asta Cfz: 1kit</p> <p><i>Adjustable 300Kg roller's with rod shimming blocks Pkg: 1kit</i></p>
--	--

	<p>ACP 90138</p> <p>Coppia di carrelli aggiuntivi per 400Kg Cfz: 1kit</p> <p><i>Additional roller's, up to 400Kg Pkg: 1kit</i></p>
--	---

	<p>ACP 90215</p> <p>Catenaccio per micro ventilazione Cfz: 1pz</p> <p><i>Bolt for micro-ventilation Pkg: 1pcs</i></p>
--	--

	<p>ACP 8043</p> <p>Dispositivo arresto anta. Disponibile nei colori bianco, nero e grigio Cfz: 10pz</p> <p><i>Stop sash. Available white, black and grey Pkg: 10pcs</i></p>
--	--

ELENCO ACCESSORI THERMOPOSA

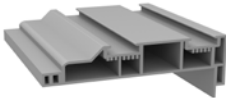
	<p>AGP 5030/I</p> <p>Profilo portaintonaco per esterno con asole 250cm Cfz: 1br</p> <p><i>Outdoor plaster profile Pkg: 1rod</i></p>		<p>AGP 5036</p> <p>Schiuma poliuretanic elastica fissaggio controtelaio ACP 6246 Cfz: 1pz</p> <p><i>Elastic polyurethane foam for ACO 6246 Pkg: 1pcs</i></p>
	<p>AGP 5031</p> <p>Profilo portaintonaco per interno con asole 250cm Cfz: 1br</p> <p><i>Inner plaster profile Pkg: 1rod</i></p>		<p>AGP 5037</p> <p>Nastro in schiuma di PVC per soglia e traverso inferiore Cfz: 20m</p> <p><i>PVC foam band for tramson and threshold Pkg: 20m</i></p>
	<p>AGP 5032</p> <p>Barriera vapore per controtelaio ACP 6246 Cfz: 30m</p> <p><i>Vapor barrier for ACP 6246 Pkg: 30m</i></p>		<p>AGP 5035/...</p> <p>Sigillante MS Polimero bianco, marrone, grigio o nero Cfz: 1pz</p> <p><i>MS Polymer Sealant Pkg: 1pcs</i></p>
	<p>AGP 5033</p> <p>Nastro precompresso BG1 da 15mm per sigillatura della battuta Cfz: 15m</p> <p><i>BG1 beat sealing, 15mm Pkg: 15m</i></p>		<p>AGP 5025</p> <p>Adesivo High Tack a base di MS polimero ad effetto ventosa bianco Cfz: 12pz</p> <p><i>High Tack MS Polymer adhesive sealant with suction effect - white Pkg: 12pcs</i></p>
	<p>AGP 5034/25</p> <p>Nastro precompresso per la sigillatura della spalla Cfz: 7m</p> <p><i>Band for laying batting, wall sealing Pkg: 7m</i></p>		<p>ACP 6248/25</p> <p>Controtelaio Thermopro 140mm, battuta 25 rifilabile Cfz: 3m</p> <p><i>Thermopro Subframe 140mm, beat 25 Pkg: 3m</i></p>

	ACP 6249
	<p>Traverso inferiore 40mm Thermopro in PVC Cfz: 3m</p> <p><i>Thermopro PVC sill transom Pkg: 3m</i></p>

	ACP 6255
	<p>Zanche per fissaggio del controtelaio per ACP 6248/25 Cfz: 1pz</p> <p><i>Clamps for fixing of subframe for ACP 6248/25 Pkg: 1pcs</i></p>

	ACP 6220
	<p>Traverso inferiore 20mm Thermopro in PVC Cfz: 3m</p> <p><i>Thermopro PVC sill transom 20mm Pkg: 3m</i></p>

	ACP 6258
	<p>Squadretta di rinforzo per controtelaio ACP 6248/25 Cfz: 1pz</p> <p><i>Reinforced bracket for ACP 6248/25 Pkg: 1pcs</i></p>

	ACP 6254
	<p>Staffe per traverso ACP 6249 Cfz: 1pz</p> <p><i>Transom bracket for ACP 6249 Pkg: 1pcs</i></p>

	ACP 6256
	<p>Squadretta angolare per controtelaio ACP 6248/25 Cfz: 1pz</p> <p><i>Corner cleat for ACP 6248/25 Pkg: 1pcs</i></p>

	ACP 6260
	<p>Staffe per traverso ACP 6220 Cfz: 1pz</p> <p><i>Transom bracket for ACP 6220 Pkg: 1pcs</i></p>

	ACP 6259
	<p>Rinforzo tubolare aperto in acciaio 12x40mm per controtelaio ACP 6248/25 Cfz: 1pz</p> <p><i>Steel tubular reinforcement 12x40mm for ACP 6248/25 Pkg: 1pcs</i></p>

	ACP 6257
	<p>Piastra di allineamento per controtelaio ACP 6248/25 Cfz: 1pz</p> <p><i>Alignment plate for ACP 6248/25 Pkg: 1pcs</i></p>

	ACP 1000/50	ACP 1000/70	ACP 1000/80	ACP 1000/90
	Vite TORX testa cilindrica T30 7,5x50 Cfz: 100pz <i>Screw with socket head Pkg: 100pcs</i>	Vite TORX testa cilindrica T30 7,5x70 Cfz: 100pz <i>Screw with socket head Pkg: 100pcs</i>	Vite TORX testa cilindrica T30 7,5x80 Cfz: 100pz <i>Screw with socket head Pkg: 100pcs</i>	Vite TORX testa cilindrica T30 7,5x90 Cfz: 100pz <i>Screw with socket head Pkg: 100pcs</i>
	ACP 1000/100	ACP 1000/110	ACP 1000/120	ACP 1000/130
	Vite TORX testa cilindrica T30 7,5x100 Cfz: 100pz <i>Screw with socket head Pkg: 100pcs</i>	Vite TORX testa cilindrica T30 7,5x110 Cfz: 100pz <i>Screw with socket head Pkg: 100pcs</i>	Vite TORX testa cilindrica T30 7,5x120 Cfz: 100pz <i>Screw with socket head Pkg: 100pcs</i>	Vite TORX testa cilindrica T30 7,5x130 Cfz: 100pz <i>Screw with socket head Pkg: 100pcs</i>
	ACP 1000/150	ACP 1000/180	ACP 1000/210	
Vite TORX testa cilindrica T30 7,5x150 Cfz: 100pz <i>Screw with socket head Pkg: 100pcs</i>	Vite TORX testa cilindrica T30 7,5x180 Cfz: 100pz <i>Screw with socket head Pkg: 100pcs</i>	Vite TORX testa cilindrica T30 7,5x210 Cfz: 100pz <i>Screw with socket head Pkg: 100pcs</i>		

	ACP 1001/50	ACP 1001/70	ACP 1001/80	ACP 1001/90
	Vite TORX testa svasata T30 7,5x50 Cfz: 100pz <i>Countersunk screw Pkg: 100pcs</i>	Vite TORX testa svasata T30 7,5x70 Cfz: 100pz <i>Countersunk screw Pkg: 100pcs</i>	Vite TORX testa svasata T30 7,5x80 Cfz: 100pz <i>Countersunk screw Pkg: 100pcs</i>	Vite TORX testa svasata T30 7,5x90 Cfz: 100pz <i>Countersunk screw Pkg: 100pcs</i>
	ACP 1001/100	ACP 1001/110	ACP 1001/120	ACP 1001/130
	Vite TORX testa svasata T30 7,5x100 Cfz: 100pz <i>Countersunk screw Pkg: 100pcs</i>	Vite TORX testa svasata T30 7,5x110 Cfz: 100pz <i>Countersunk screw Pkg: 100pcs</i>	Vite TORX testa svasata T30 7,5x120 Cfz: 100pz <i>Countersunk screw Pkg: 100pcs</i>	Vite TORX testa svasata T30 7,5x130 Cfz: 100pz <i>Countersunk screw Pkg: 100pcs</i>
	ACP 1001/150	ACP 1001/180	ACP 1001/210	
Vite TORX testa svasata T30 7,5x150 Cfz: 100pz <i>Countersunk screw Pkg: 100pcs</i>	Vite TORX testa svasata T30 7,5x180 Cfz: 100pz <i>Countersunk screw Pkg: 100pcs</i>	Vite TORX testa svasata T30 7,5x210 Cfz: 100pz <i>Countersunk screw Pkg: 100pcs</i>		

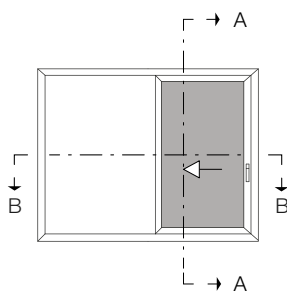

Slide window
1 rail 1 sash

Scorrevole alzante
monovia 1 anta

Glass list

Distinta vetri

Pezzi	L	H
1	L-219	H-226

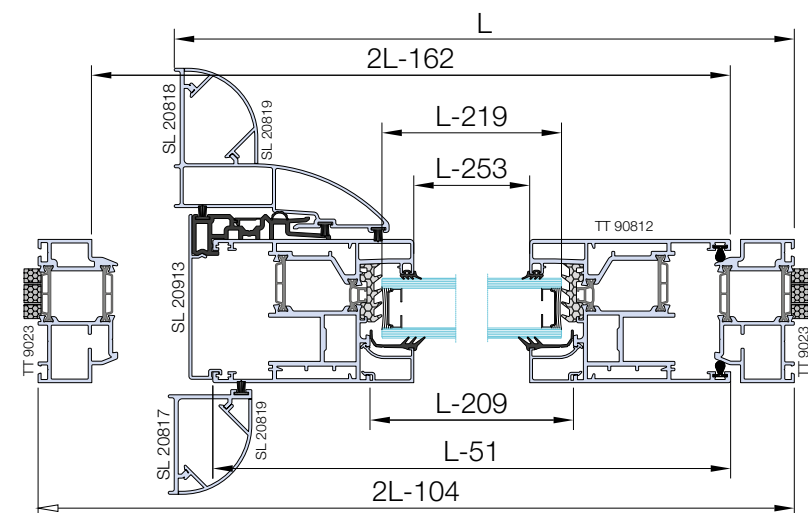

Sez. B-B

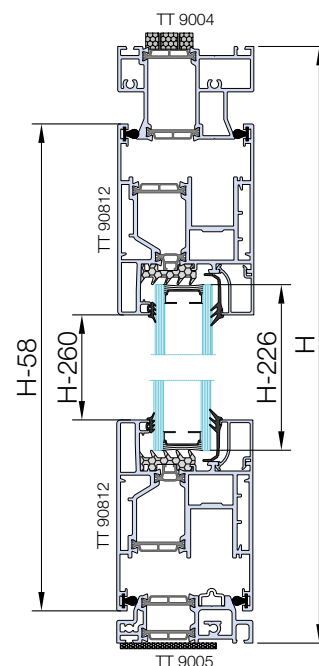

Sez. A-A

Art.	Descrizione	q.tà	Misura	Taglio	Distinta profili
TT 9023	Montante telaio Mullion frame	2	H		Distinta profili
TT 9005	Traverso inferiore telaio Bottom transom frame	1	2L-162		
TT 9004	Traverso superiore telaio Top transom frame	1	2L-162		
TT 90812	Traverso anta Transom sash	2	L-51		
	Montante anta Mullion sash	2	H-58		
SL 20913	Montante riporto cen. Mullion astragal	1	H-58		
SL 20817	Mont. chiusura monovia Mullion closure rail	1	H		
SL 20818	Mont. chiusura monovia Mullion closure rail	1	H		
SL 20819	Montante coprivite Mullion cover screw	2	H		
SX 9901	Binario in inox Stainless steel guide	1	2L-125		
PL 1418	Fermavetro Glazing bead	2	H-260		
		2	L-209		

Art.	Descrizione	q.tà	Distinta accessori
ACP 5801	Squadretta Multifunzione Multifunction corner cleat	4	Distinta accessori
ACP 5001	Vite per ACP 5801 Screw for ACP 5801	8	
ACP 50154	Squadretta Multifunzione Multifunction corner cleat	8	
ACP 5030	Spina per ACP 50154 Dowel pin for ACP 50154	16	
ACP 9030	Supporto vetro in alluminio Aluminium glass support	2	
SA 2904 NB	Appoggio vetro 4mm 4mm glass backing	2	
ACP 50110	Squadretta allineamento anta Alignment corner bracket	4	
ACP 90101	Maniglione alluminio con vaschetta Handle+recessed handle	1	
ACP 90112M	Asta collegamento Connection rod	1	
ACP 90113M	Asta di comando Control rod	1	
ACP 5036	Regolo muro Wall spacer	9	
ACP 90118M	Kit base carrelli Roller base kit	1	
ACP 9033M	Kit componenti plastici Plastic elements kit	1	
ACP 90115M	Punto di chiusura Locking point	1	

Art.	Descrizione	q.tà	Misura	Distinta guarnizioni
AGP 9005	Battuta Rabbit gasket	4	L-51	Distinta guarnizioni
		2	H-58	
AGP 4013	Vetro esterna External glass gasket	2	L-219	
AGP 4106	Vetro interna Internal glass gasket	2	L-219	
		2	H-226	
AGP 5034/25	Isolamento spalla Abutment insulation	2	H	
		1	L	
TAC 903	Incontro centrale Incontro centrale	2	H-58	
AGP 8005	Spazzolino Brush	4	H-58	
AGP 40131	Sotto vetro Glazing strip	2	L-206	
		2	H-206	
AGP 5037	Isolamento muro Wall insulation	4	L	

DISTINTE DITAGLIO

Cutting lists

Lift & side window
2 rail / 2 sash

Scorrevole alzante
2 vie 2 ante
Distinta vetri

Glass list

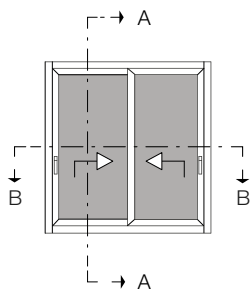

Pezzi	L	H
2	L/2-156	H-226

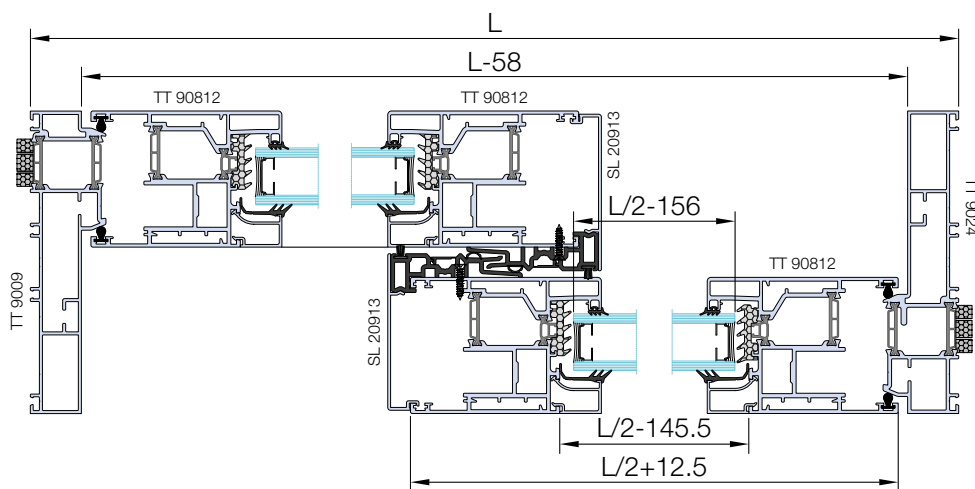

Sez. B-B

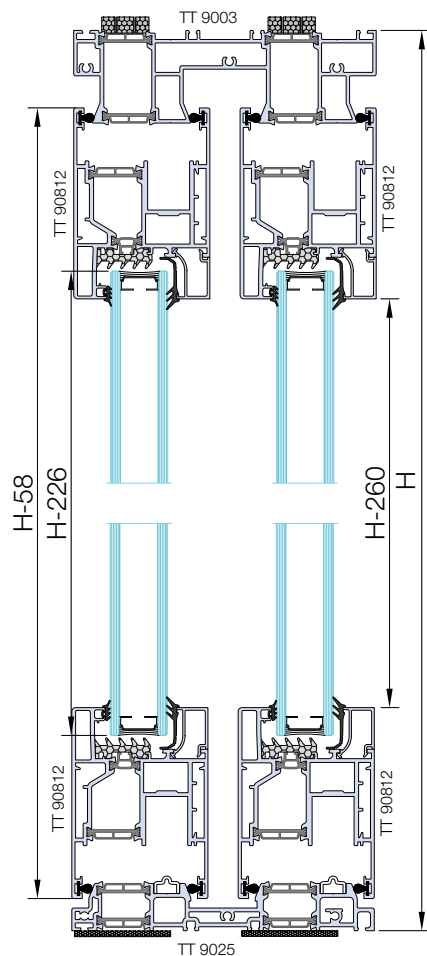

Sez. A-A

Art.	Descrizione	q.tà	Misura	Taglio
TT 9009	Montante telaio <i>Mullion frame</i>	1	H	
TT 9024	Montante telaio <i>Mullion frame</i>	1	H	
TT 90812	Traverso anta <i>Transom sash</i>	4	L/2+12.5	
	Montante anta <i>Mullion sash</i>	4	H-58	
SL 20913	Montante riporto centrale <i>Mullion astragal</i>	2	H-58	
TT 9025	Traverso telaio inferiore <i>Bottom transom frame</i>	1	L-58	
TT 9003	Traverso telaio superiore <i>Top transom frame</i>	1	L-58	
SX 9901	Binario in inox <i>Stainless steel guide</i>	2	L-69	
PL 1418	Fermavetro <i>Glazing bead</i>	4	H-260	
		4	L/2-145.5	

Distinta profili

Profiles list

DISTINTE DI TAGLIO

Cutting lists

Art.	Descrizione	q.tà	Misura
AGP 9005	Battuta <i>Rabbit gasket</i>	8	L/2+12.5
		4	H+58
AGP 4013	Vetro esterna <i>External glass gasket</i>	4	L/2-156
		4	H-226
AGP 4106	Vetro interna <i>Internal glass gasket</i>	4	L/2-156
		4	H226
AGP 5034/25	Isolamento spalla <i>Abutment insulation</i>	2	H
		2	L
TAC 903	Incontro centrale <i>Incontro centrale</i>	2	H-58
AGP 8005	Spazzolino <i>Brush</i>	2	H-58
AGP 40131	Sotto vetro <i>Galzing strip</i>	4	L/2-136
		4	H-206
AGP 5037	Isolamento muro <i>Wall insulation</i>	2	L

Distinta guarnizioni

Gaskets list

Distinta accessori

Accessories

Art.	Descrizione	q.tà
ACP 5801	Squadretta Multifunzione <i>Multifunction corner cleat</i>	8
ACP 5001	Vite per ACP 5801 <i>Screw for ACP 5801</i>	16
ACP 50154	Squadretta Multifunzione <i>Multifunction corner cleat</i>	16
ACP 5030	Spina per ACP 50154 <i>Dowel pin for ACP 50154</i>	32
ACP 9030	Supporto vetro in alluminio <i>Aluminium glass support</i>	4
SA 2904 NB	Appoggio vetro 4mm <i>4mm glass backing</i>	4
ACP 50110	Squadretta allineamento anta <i>Alignment corner bracket</i>	8
ACP 90101	Maniglia alluminio con vaschetta <i>Handle+recessed handle</i>	2
ACP 90112M	Asta collegamento <i>Connection rod</i>	2
ACP 90113M	Asta di comando <i>Control rod</i>	2
ACP 5036	Regolo muro metallo <i>Metal wall spacer</i>	18
ACP 9035M	Kit spugne <i>Kit seal elements</i>	1
ACP 90118M	Kit base carrelli <i>Rail base kit</i>	2
ACP 9033M	Kit componenti plastici <i>Plastic element kit</i>	1
ACP 90115M	Punto di chiusura <i>Locking point</i>	2
ACP 8043	Paracolpo <i>Bumper</i>	1
ACP 9028	Cappetta scarico acqua <i>Plug for water drainage</i>	2

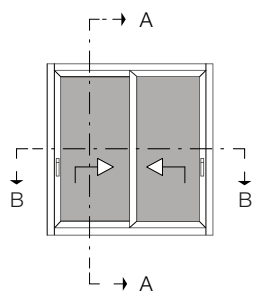

Lift & side window+low threshold
2 rail / 2 sash

Scorrevole alzante
2 vie 2 ante con soglia ribassata

Glass list

Distinta vetri

Pezzi	L	H
2	L/2-156	H-213.5

Sez. A-A

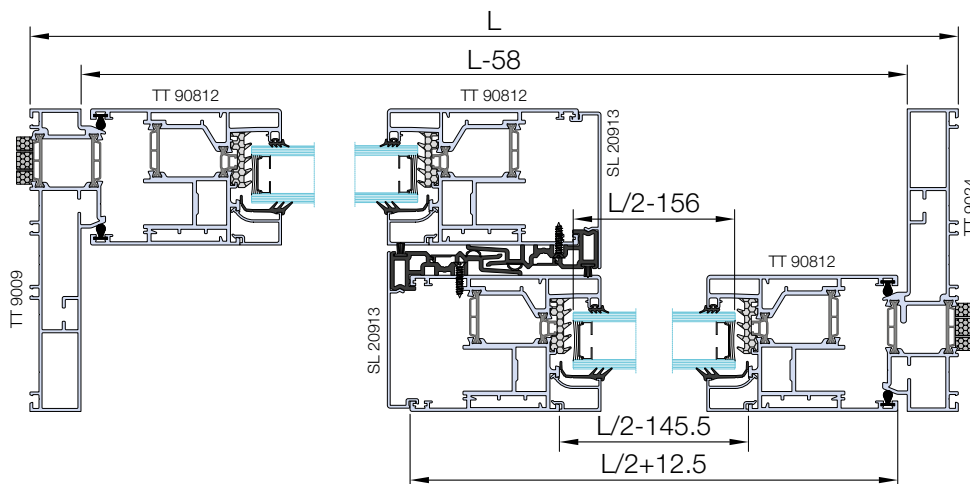
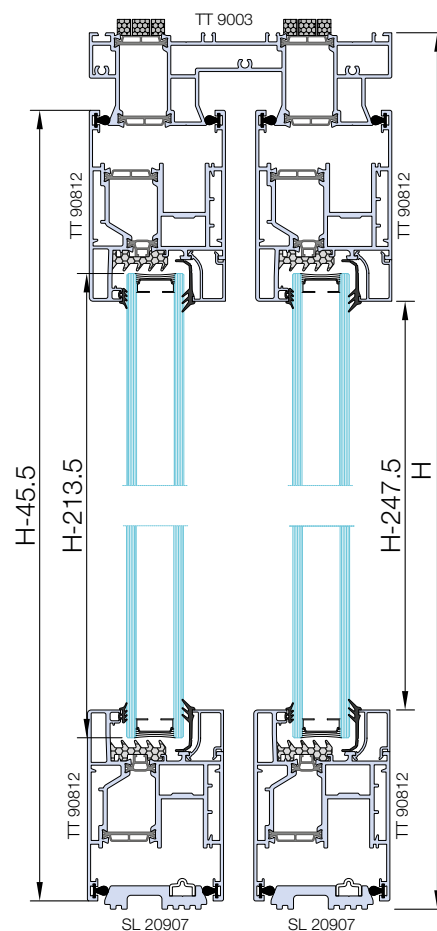

Sez. B-B

Art.	Descrizione	q.tà	Misura	Taglio
TT 9009	Montante telaio <i>Mullion frame</i>	1	H	
TT 9024	Montante telaio <i>Mullion frame</i>	1	H	
TT 90812	Traverso anta <i>Transom sash</i>	4	L/2+12.5	
	Montante anta <i>Mullion sash</i>	4	H-45.5	
SL 20913	Montante riporto centrale <i>Mullion astragal</i>	2	H-45.5	
SL 90907	Soglia ribassata <i>Low threshold</i>	2	L-54	
TT 9003	Traverso telaio superiore <i>Top transom frame</i>	1	L-58	
SX 9901	Binario in inox <i>Stainless steel guide</i>	2	L-69	
PL 1418	Fermavetro <i>Glazing bead</i>	4	H-247.5	
		4	L/2-145.5	

Art.	Descrizione	q.tà
ACP 5801	Squadretta Multifunzione <i>Multifunction corner cleat</i>	8
ACP 5001	Vite per ACP 5801 <i>Screw for ACP 5801</i>	16
ACP 50154	Squadretta Multifunzione <i>Multifunction corner cleat</i>	16
ACP 5030	Spina per ACP 50154 <i>Dowel pin for ACP 50154</i>	32
ACP 9030	Supporto vetro in alluminio <i>Aluminium glass support</i>	4
SA 2904 NB	Appoggio vetro 4mm <i>4mm glass backing</i>	4
ACP 50110	Squadretta allineamento anta <i>Alignment corner bracket</i>	8
ACP 90101	Maniglione alluminio con vaschetta <i>Handle+recessed handle</i>	2
ACP 90112M	Asta collegamento <i>Connection rod</i>	2
ACP 90113M	Asta di comando <i>Control rod</i>	2
ACP 5036	Regolo muro metallo <i>Metal wall spacer</i>	18
ACP 9035M	Kit spugne <i>Sponge kit</i>	1
ACP 90118M	Kit base carrelli <i>Rail base kit</i>	2
ACP 9033M	Kit componenti plastici <i>Plastic element kit</i>	1
ACP 90115M	Punto di chiusura <i>Locking point</i>	2
ACP 8043	Paracolpo <i>Bumper</i>	1
ACP 8042	Spugna di tenuta <i>Foam for low threshold</i>	2

Distinta accessori

Accessories

Art.	Descrizione	q.tà	Misura
AGP 9005	Battuta <i>Rabbit gasket</i>	8	L/2+12.5
		4	H-58
AGP 4013	Vetro esterna <i>External glass gasket</i>	4	L/2-156
		4	H-213.5
AGP 4106	Vetro interna <i>Internal glass gasket</i>	4	L/2-156
		4	H-213.5
AGP 4099	Isolamento spalla <i>Abutment insulation</i>	4	H
		4	L
TAC 903	Incontro centrale <i>Incontro centrale</i>	2	H-45.5
AGP 8005	Spazzolino <i>Brush</i>	2	H-45.5
AGP 40131	Sotto vetro <i>Glazing strip</i>	4	L/2-136
		4	H-203.5

Distinta guarnizioni

Gaskets list

DISTINTE DITAGLIO

Cutting lists

Lift & side window
3 rail / 3 sash

Scorrevole alzante
3 vie 3 ante
Distinta vetri

Glass list

Pezzi	L	H
3	L/3-130	H-226

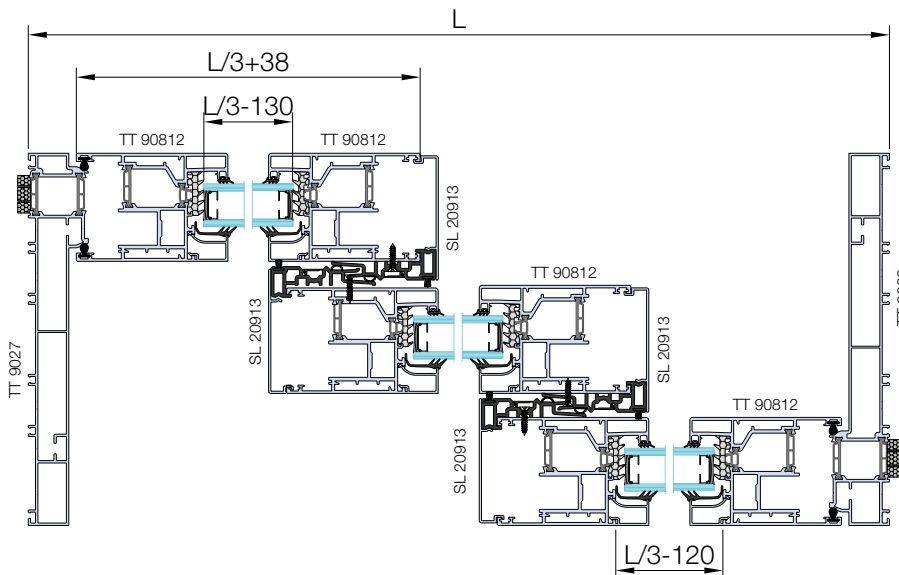
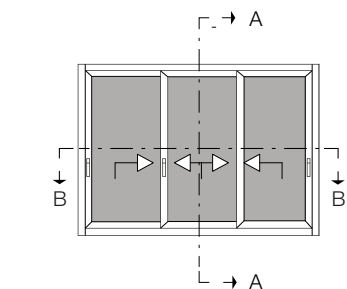

Sez. B-B

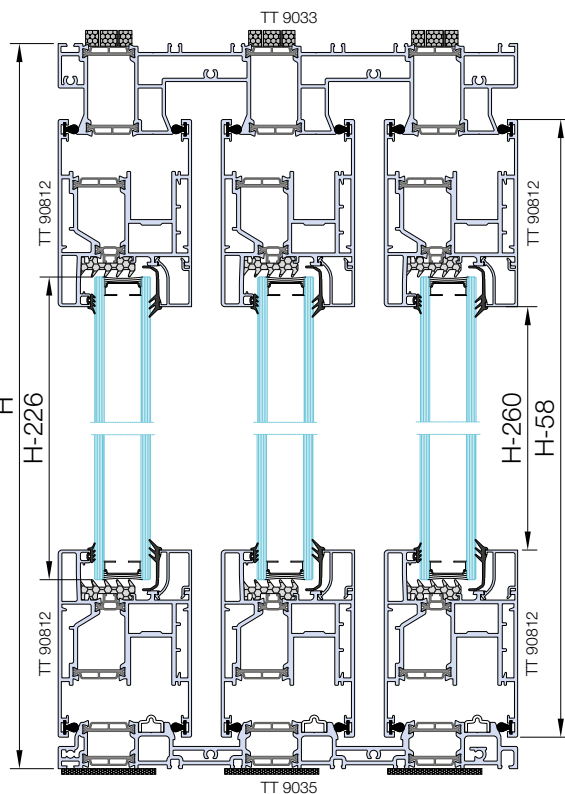

Sez. A-A

Distinta profili

Profiles list

Art.	Descrizione	q.tà	Misura	Taglio
TT 9026	Montante telaio Mullion frame	1	H	
TT 9027	Montante telaio Mullion frame	1	H	
TT 90812	Traverso anta Transom sash	6	L/3+38	
	Montante anta Mullion sash	6	H-58	
SL 20913	Montante riporto centrale Mullion astragal	4	H-58	
TT 9035	Traverso telaio inferiore Bottom transom frame	1	L-58	
TT 9033	Traverso telaio superiore Top transom frame	1	L-58	
SX 9901	Binario in inox Stainless steel guide	3	L-69	
PL 1418	Fermavetro Glazing bead	6	H-260	
		6	L/3-120	

Distinta accessori

Accessories

Art.	Descrizione	q.tà
ACP 5801	Squadretta Multifunzione Multifunction corner cleat	12
ACP 5001	Vite per ACP 5801 Screw for ACP 5801	24
ACP 50154	Squadretta Multifunzione Multifunction corner cleat	24
ACP 5030	Spina per ACP 50154 Dowel pin for ACP 50154	48
ACP 9030	Supporto vetro in alluminio Aluminium glass support	6
SA 2904 NB	Appoggio vetro 4mm 4mm glass backing	6
ACP 50110	Squadretta allineamento anta Alignment corner bracket	12
ACP 90101	Maniglione alluminio con vaschetta Handle+recessed handle	3
ACP 90112M	Asta collegamento Connection rod	3
ACP 90113M	Asta di comando Control rod	3
ACP 5036	Regolo muro metallo Metal wall spacer	18
ACP 9035M	Kit spugne Kit seal elements	2
ACP 90118M	Kit base carrelli Rail base kit	3
ACP 9033M	Kit componenti plastici Plastic element kit	2
ACP 90115M	Punto di chiusura Locking point	2
ACP 8043	Paracolpo Bumper	2
ACP 9028	Cappetta scarico acqua, 2 vie Plug for water drainage, 2 rails	2
ACP 9034	Cappetta scarico acqua, 3 vie Plug for water drainage, 3 rails	2

Distinta guarnizioni

Gaskets list

Art.	Descrizione	q.tà	Misura
AGP 9005	Battuta Rabbit gasket	12	L/3+38
		4	H-58
AGP 4013	Vetro esterna External glass gasket	6	L/3-130
		6	H-226
AGP 4106	Vetro interna Internal glass gasket	6	L/3-130
		6	H226
AGP 5034/25	Isolamento spalla Abutment insulation	2	H
		3	L
TAC 903	Incontro centrale Incontro centrale	4	H-58
AGP 8005	Spazzolino Brush	4	H-58
AGP 40131	Sotto vetro Glazing strip	6	L/3-130
		6	H-206
AGP 5037	Isolamento muro Wall insulation	3	L

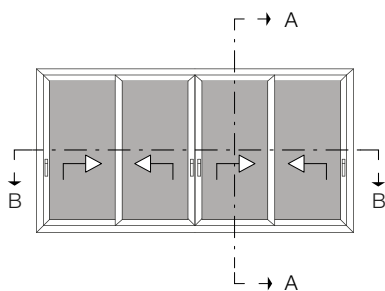

Lift & side window
2 rail / 4 sash

Glass list

Scorrevole alzante
2 vie 4 ante
Distinta vetri

Pezzi	L	H
4	L/4-141	H-226

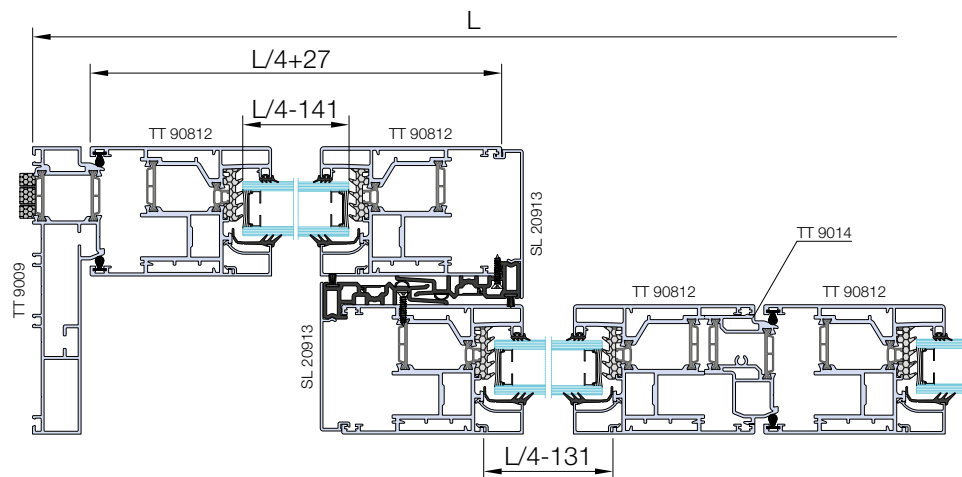

Sez. B-B

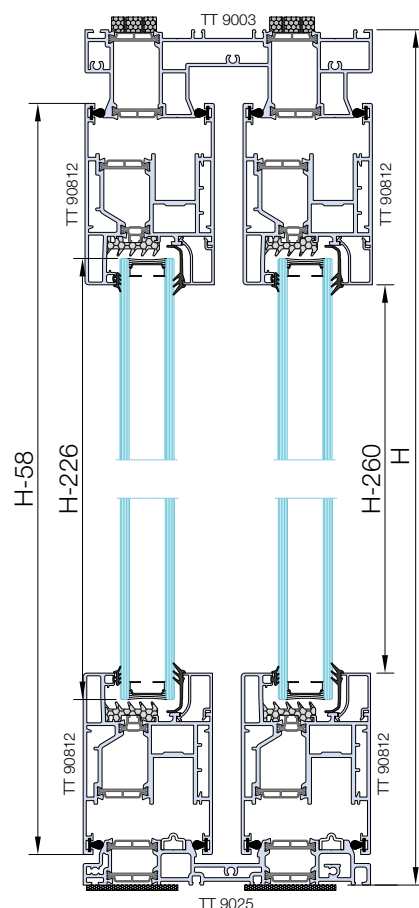

Sez. A-A

Art.	Descrizione	q.tà	Misura	Taglio	Distinta profili
TT 9009	Montante telaio <i>Mullion frame</i>	2	H		Profili list
TT 9025	Traverso telaio inferiore <i>Bottom transom frame</i>	1	L-58		
TT 90812	Traverso anta <i>Transom sash</i>	8	L/4+27		
	Montante anta <i>Mullion sash</i>	8	H-58		
SL 20913	Montante riporto centrale <i>Mullion astragal</i>	4	H-58		
TT 9014	Incontro ante <i>Closure profile</i>	1	H-104		
TT 9003	Traverso telaio superiore <i>Top transom frame</i>	1	L-58		
SX 9901	Binario in inox <i>Stainless steel guide</i>	2	L-69		
PL 1418	Fermavetro <i>Glazing bead</i>	8	L/4-131		
		8	H-260		

Art.	Descrizione	q.tà	Distinta accessori
ACP 5801	Squadretta Multifunzione <i>Multifunction corner cleat</i>	16	Accessories
ACP 5001	Vite per ACP 5801 <i>Screw for ACP 5801</i>	32	
ACP 50154	Squadretta Multifunzione <i>Multifunction corner cleat</i>	32	
ACP 5030	Spina per ACP 50154 <i>Dowel pin for ACP 50154</i>	64	
ACP 9030	Supporto vetro in alluminio <i>Aluminium glass support</i>	8	
SA 2904 NB	Appoggio vetro 4mm <i>4mm glass backing</i>	8	
ACP 50110	Squadretta allineamento anta <i>Alignment corner bracket</i>	16	
ACP 90101	Maniglione alluminio con vaschetta <i>Handle+recessed handle</i>	4	
ACP 90112M	Asta collegamento <i>Connection rod</i>	4	
ACP 90113M	Asta di comando <i>Control rod</i>	4	
ACP 5036	Regolo muro metallo <i>Metal wall spacer</i>	20	
ACP 9035M	Kit spugne <i>Sponge kit</i>	2	
ACP 90118M	Kit base carrelli <i>Rail base kit</i>	4	
ACP 9033M	Kit componenti plastici <i>Plastic element kit</i>	2	
ACP 90115M	Punto di chiusura <i>Locking point</i>	3	
ACP 8043	Paracolpo <i>Bumper</i>	4	
ACP 9028	Cappetta scarico acqua, 2 vie <i>Plug for water drainage, 2rails</i>	4	
ACP 9029	Tappi ante frontali <i>Plug for frontal sash</i>	1 cp.	

Art.	Descrizione	q.tà	Misura	Distinta guarnizioni
AGP 9005	Battuta <i>Rabbit gasket</i>	6	H-58	Gaskets list
		8	L/4+27	
AGP 4014	Vetro esterna <i>External glass gasket</i>	8	L/4-141	
AGP 4106	Vetro interna <i>Internal glass gasket</i>	8	L/4-141	
		8	H-226	
AGP 5034/25	Isolamento spalla <i>Abutment insulation</i>	2	H	
		2	L	
TAC 903	Incontro centrale <i>Incontro centrale</i>	4	H-58	
AGP 8005	Spazzolino <i>Brush</i>	4	H-58	
AGP 40131	Sotto vetro <i>Galzing strip</i>	8	L/4-141	
		8	H-206	
AGP 5037	Isolamento muro <i>Wall insulation</i>	2	L	

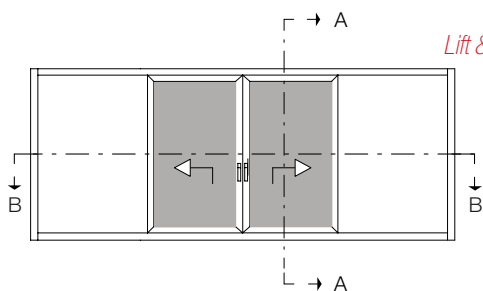

Lift & side widown
1 rail / 2 sash

Scorrevole alzante
monovia 2 ante
Distinta vetri

Glass list

Pezzi	L	H
2	L/2-190	H-213

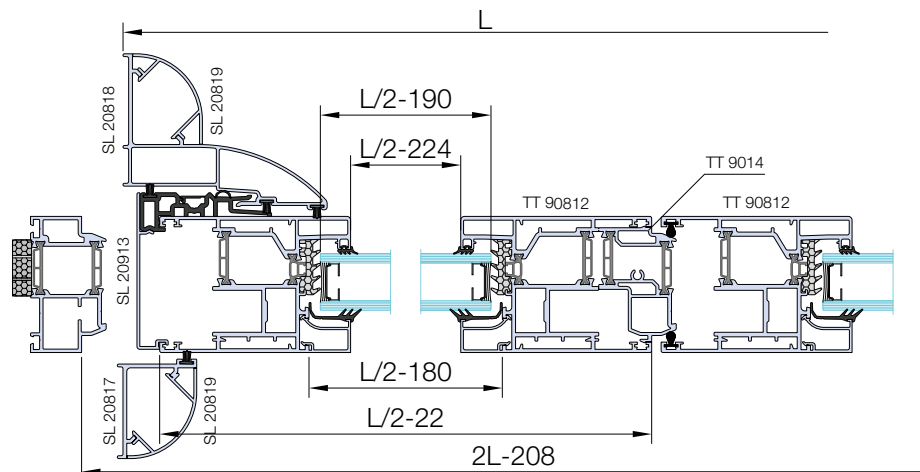

Sez. B-B

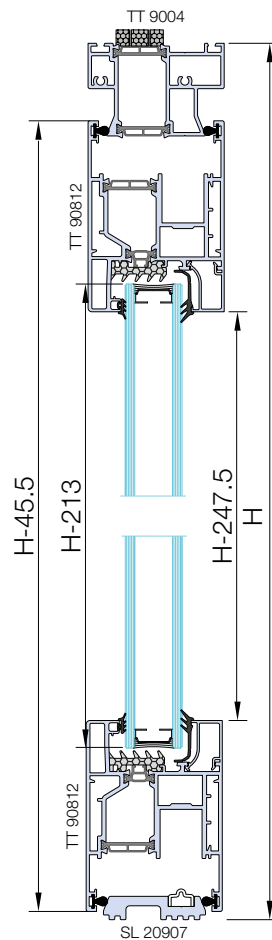

Sez. A-A

Distinta profili

Profiles list

Art.	Descrizione	q.tà	Misura	Taglio
TT 9023	Montante telaio Mullion frame	2	H	
SL 20907	Traverso telaio inferiore Bottom transom frame	1	2L-204	
TT 90812	Traverso anta Transom sash	4	L/2-22	
	Montante anta Mullion sash	4	H-45.5	
SL 20913	Montante riporto centrale Mullion astragal	1	H-45.5	
TT 9004	Traverso telaio superiore Top transom frame	1	2L-208	
SL 20817	Montante chiusura monovia Mullion closure rail	1	H	
SL 20818	Montante chiusura monovia Mullion closure rail	1	H	
SL 20819	Montante coprivite Mullion cover screw	2	H	
SX 9901	Binario in inox Stainless steel guide	1	2L-208	
PL 1418	Fermavetro Glazing bead	2	H-247.5	
		2	L/2-224	
TT 9014	Incontro ante Closure profile	1	H-91.5	

Distinta accessori

Accessories

Art.	Descrizione	q.tà
ACP 5801	Squadretta Multifunzione Multifunction corner cleat	8
ACP 5001	Vite per ACP 5801 Screw for ACP 5801	16
ACP 50154	Squadretta Multifunzione Multifunction corner cleat	16
ACP 5030	Spina per ACP 50154 Dowel pin for ACP 50154	32
ACP 9030	Supporto vetro in alluminio Aluminium glass support	4
SA 2904 NB	Appoggio vetro 4mm 4mm glass backing	4
ACP 50110	Squadretta allineamento anta Alignment corner bracket	8
ACP 90101	Maniglione alluminio con vaschetta Handle+recessed handle	2
ACP 90112M	Asta collegamento Connection rod	2
ACP 90113M	Asta di comando Control rod	2
ACP 5036	Regolo muro metallo Metal wall spacer	10
ACP 90118M	Kit base carrelli Rail base kit	2
ACP 9033M	Kit componenti plastici Plastic element kit	1
ACP 90115M	Punto di chiusura Locking point	1
ACP 8043	Paracolpo Bumper	2
ACP 9029	Tappi ante frontali Plug for frontal sash	1 cp.

Distinta guarnizioni

Gaskets list

Art.	Descrizione	q.tà	Misura
AGP 9005	Battuta Rabbit gasket	4	L/2-41
		2	H-45.5
AGP 4013	Vetro esterna External glass gasket	2	L/2-190
		2	H-213
AGP 4106	Vetro interna Internal glass gasket	2	L/2-190
		2	H-213
AGP 5034/25	Isolamento spalla Abutment insulation	2	H
		1	L
TAC 903	Incontro centrale Incontro centrale	2	H-45.5
AGP 8005	Spazzolino Brush	6	H-45.5
AGP 40131	Sotto vetro Galzing strip	2	L/2-178
		2	H-203.5

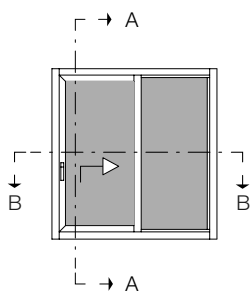

Lift & side window
1 rail + fixed

Scorrevole alzante
monovia + fisso 1 anta

Glass list

Distinta vetri

Pezzi	L	H
1	L/2-156	H-226
1	L/2-72	H-64

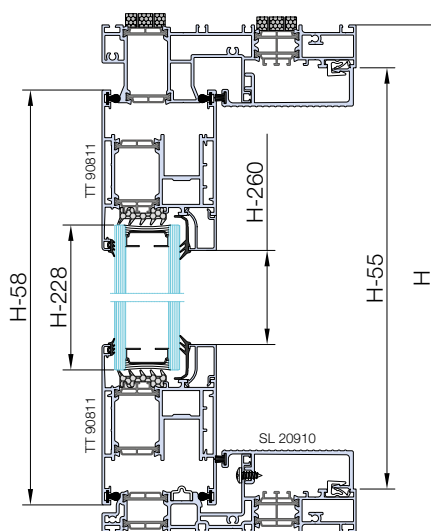

Sez. A-A

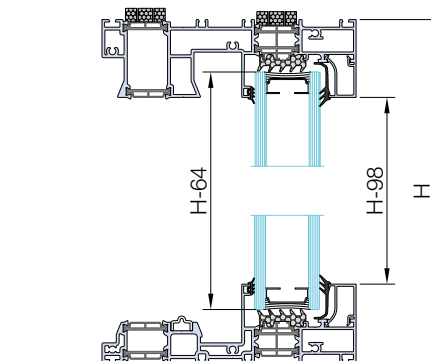

Sez. B-B

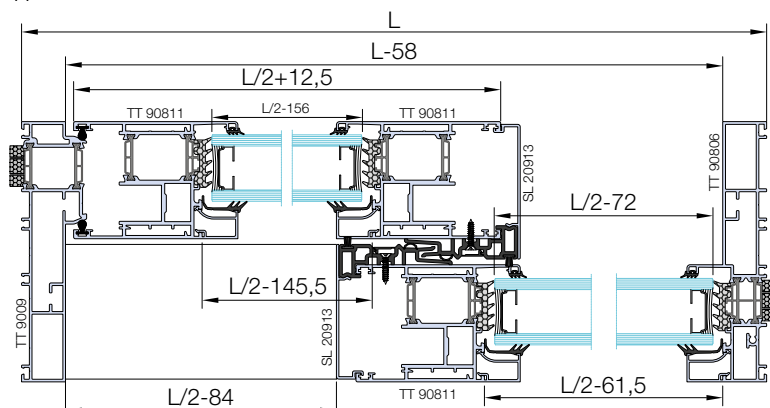

Art.	Descrizione	q.tà	Misura	Taglio
TT 9009	Montante telaio <i>Mullion frame</i>	1	H	
TT 90806	Montante telaio <i>Mullion frame</i>	1	H	
TT 90811	Traverso anta <i>Transom sash</i>	2	L/2+12,5	
	Montante anta <i>Mullion sash</i>	2	H-58	
	Montante anta <i>Mullion sash</i>	1	H-45	
SL 20913	Montante riporto centrale <i>Mullion astragal</i>	1	H-58	
SL 20913	Montante riporto centrale <i>Mullion astragal</i>	1	H-54	
SL 20910	Coprisoglia <i>Threshold cover</i>	2	L/2-84	
TT 90801	Traverso telaio superiore <i>Top transom frame</i>	1	L-58	
TT 90802	Traverso telaio inferiore <i>Bottom transom frame</i>	1	L-58	
SX 9901	Binario in inox <i>Stainless steel guide</i>	1	L-69	
PL 1418	Fermavetro <i>Glazing bead</i>	2	L/2-145,5	
		2	L/2-61,5	
		2	H-260	
		2	H-98	

Art.	Descrizione	q.tà	Misura
AGP 9005	Battuta <i>Rabbit gasket</i>	4	L/2+12,5
		2	H-58
AGP 4013	Vetro esterna <i>External glass gasket</i>	2	L/2-156
		2	L/2-72
		2	H-226
		2	H-64
AGP 4106	Vetro interna <i>Internal glass gasket</i>	2	L/2-156
		2	L/2-72
		2	H-226
		2	H-64
AGP 5034/25	Isolamento spalla <i>Abutment insulation</i>	2	H
		2	L
TAC 903	Incontro centrale <i>Incontro centrale</i>	1	H-74
		1	H-58
AGP 8005	Spazzolino <i>Brush</i>	2	H-58
		2	L/2-84
		2	L/2-156
AGP 40131	Sotto vetro <i>Galzing strip</i>	2	L/2-72
		2	H-226
		2	H-64
AGP 5037	Isolamento muro <i>Wall insulation</i>	2	L

Art.	Descrizione	q.tà
ACP 5801	Squadretta Multifunzione <i>Multifunction corner cleat</i>	4
ACP 5001	Vite per ACP 5801 <i>Screw for ACP 5801</i>	8
ACP 50154	Squadretta Multifunzione <i>Multifunction corner cleat</i>	8
ACP 5030	Spina per ACP 50154 <i>Dowel pin for ACP 50154</i>	16
ACP 9030	Supporto vetro in alluminio <i>Aluminium glass support</i>	2
SA 2904 NB	Appoggio vetro 4mm <i>4mm glass backing</i>	2
ACP 50110	Squadretta allineamento anta <i>Alignment corner bracket</i>	4
ACP 90101	Maniglione alluminio con vaschetta <i>Handle+recessed handle</i>	1
ACP 90112M	Asta collegamento <i>Connection rod</i>	1
ACP 90113M	Asta di comando <i>Control rod</i>	1
ACP 5036	Regolo muro metallo <i>Metal wall spacer</i>	18
ACP 9035M	Kit spugne <i>Sponge kit</i>	1
ACP 90118M	Kit base carrelli <i>Rail base kit</i>	1
ACP 9043M	Kit componenti plastici <i>Plastic element kit</i>	1
ACP 90115M	Punto di chiusura <i>Locking point</i>	1
ACP 8043	Paracolpo <i>Bumper</i>	1
ACP 9028	Cappetta scarico acqua, 2 vie <i>Plug for water drainage, 2rails</i>	2
ACP 62130	Appoggio vetro <i>Glass support</i>	2

Accessories Distinta accessori

DISTINTE DITAGLIO

Cutting lists

Lift & side window
2 rail + 2 fixed

Scorrevole alzante
monovia + 2 fissi 2 ante

Glass list

Distinta vetri

Pezzi	L	H
2	L/4-74	H-64
2	L/4-128	H-226

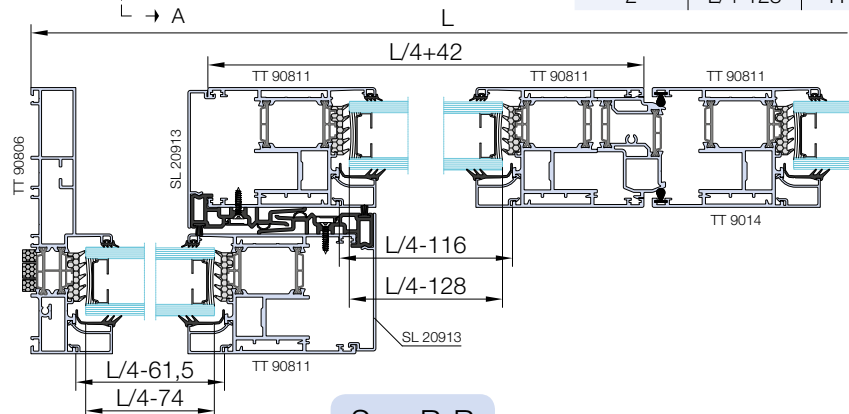
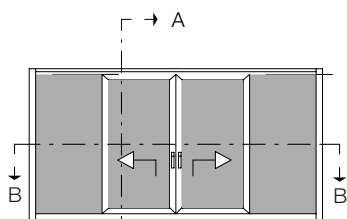

Sez. B-B

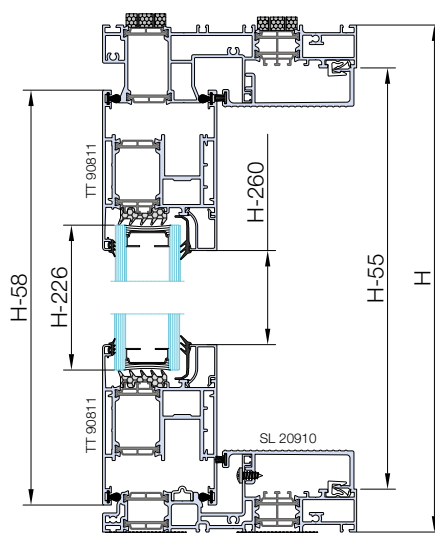

Sez. A-A

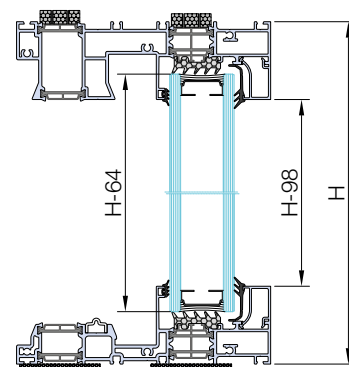

Distinta profili

Profiles list

Art.	Descrizione	q.tà	Misura	Taglio
TT 90806	Montante telaio <i>Mullion frame</i>	2	H	
TT 90802	Traverso telaio inferiore <i>Bottom transom frame</i>	1	L-58	
TT 90811	Traverso anta <i>Transom sash</i>	4	L/4+42	
	Montante anta <i>Mullion sash</i>	4	H-58	
	Montante anta <i>Mullion sash</i>	2	H-45	
SL 20913	Montante riporto centrale <i>Mullion astragal</i>	2	H-58	
SL 20913	Montante riporto centrale <i>Mullion astragal</i>	2	H-54	
SL 20910	Coprisoglia <i>Threshold cover</i>	2	L/2-113	
TT 90801	Traverso telaio superiore <i>Top transom frame</i>	1	L-58	
TT 9014	Incontro ante <i>Closure profile</i>	1	L-104	
SX 9901	Binario in inox <i>Stainless steel guide</i>	1	L-58	
PL 1418	Fermavetro <i>Glazing bead</i>	4	L/4-116	
		4	L/4-61,5	
		4	H-260	
		4	H-98	

Distinta accessori

Accessories

Art.	Descrizione	q.tà
ACP 5801	Squadretta Multifunzione <i>Multifunction corner cleat</i>	8
ACP 5001	Vite per ACP 5801 <i>Screw for ACP 5801</i>	16
ACP 50154	Squadretta Multifunzione <i>Multifunction corner cleat</i>	16
ACP 5030	Spina per ACP 50154 <i>Dowel pin for ACP 50154</i>	32
ACP 9030	Supporto vetro in alluminio <i>Aluminium glass support</i>	4
SA 2904 NB	Appoggio vetro 4mm <i>4mm glass backing</i>	4
ACP 50110	Squadretta allineamento anta <i>Alignment corner bracket</i>	8
ACP 90101	Maniglia alluminio con vaschetta <i>Handle+recessed handle</i>	2
ACP 90112M	Asta collegamento <i>Connection rod</i>	2
ACP 90113M	Asta di comando <i>Control rod</i>	2
ACP 5036	Regolo muro metallo <i>Metal wall spacer</i>	20
ACP 9035M	Kit spugne <i>Sponge kit</i>	2
ACP 90118M	Kit base carrelli <i>Rail base kit</i>	2
ACP 9043M	Kit componenti plastici <i>Plastic element kit</i>	2
ACP 90115M	Punto di chiusura <i>Locking point</i>	1
ACP 8043	Paracolpo <i>Bumper</i>	2
ACP 9028	Cappetta scarico acqua, 2 vie <i>Plug for water drainage, 2rails</i>	4
ACP 62130	Appoggio vetro <i>Glass support</i>	4
ACP 9029	Tappi ante frontali <i>Frontal sash plug</i>	1

Distinta guarnizioni

Gaskets list

Art.	Descrizione	q.tà	Misura
AGP 9005	Battuta <i>Rabbit gasket</i>	8	L/4+42
		2	H-58
AGP 4013	Vetro esterna <i>External glass gasket</i>	4	L/4-92
		4	L/4-146
		4	H-226
		4	H-64
AGP 4106	Vetro interna <i>Internal glass gasket</i>	4	L/4-92
		4	L/4-146
		4	H-226
		4	H-64
AGP 5034/25	Isolamento spalla <i>Abutment insulation</i>	2	H
TAC 903	Incontro centrale <i>Incontro centrale</i>	2	H-74
AGP 8005	Spazzolino <i>Brush</i>	2	H-58
		4	L/2-113
AGP 40131	Sotto vetro <i>Galzing strip</i>	4	L/4-105
		4	L/4-52
		4	H-226
AGP 5037	Isolamento muro <i>Wall insulation</i>	4	H-64
		2	L

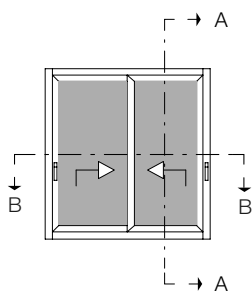

Lift & side window
2 rail / 2 sash lowered central section

Scorrevole alzante
2 vie 2 ante nodo centrale ridotto

Glass list

Distinta vetri

Pezzi	L	H
2	L/2-129	H-226

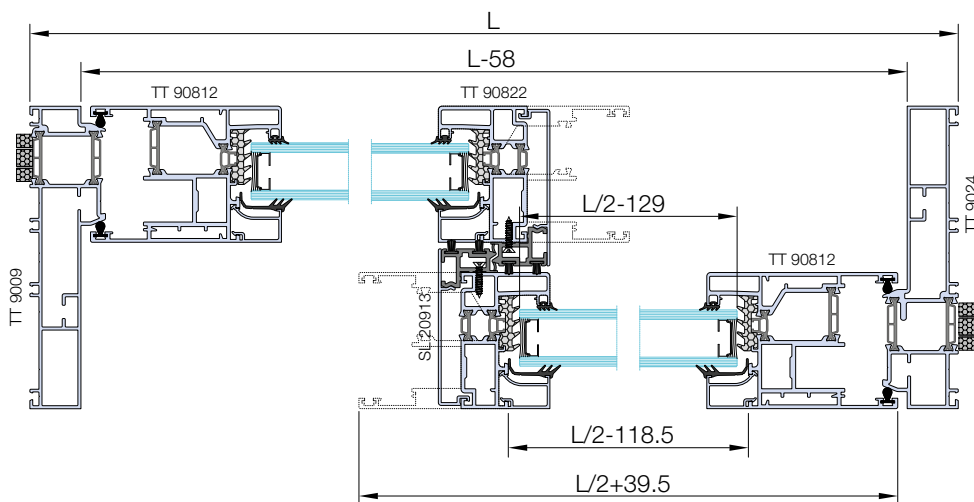

Sez. B-B

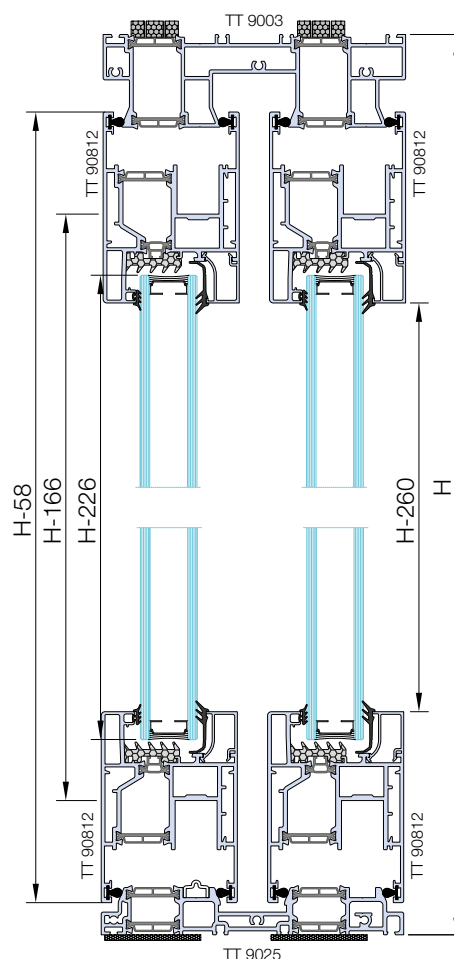

Sez. A-A

Art.	Descrizione	q.tà	Misura	Taglio
TT 9009	Montante telaio Mullion frame	1	H	
TT 9024	Montante telaio Mullion frame	1	H	
TT 90812	Traverso anta Transom sash	4	L/2+39.5	
	Montante anta Mullion sash	2	H-58	
SL 20913	Montante riporto centrale Mullion astragal	2	H-58	
TT 90822	Montante anta Mullion sash	2	H-166	
TT 9025	Traverso telaio inferiore Bottom transom frame	1	L-58	
TT 9003	Traverso telaio superiore Top transom frame	1	L-58	
SX 9901	Binario in inox Stainless steel guide	2	L-69	
PL 1418	Fermavetro Glazing bead	4	H-260	
		4	L/2-118.5	

Art.	Descrizione	q.tà	Misura
AGP 9005	Battuta Rabbit gasket	8	L/2+39.5
		4	H-58
AGP 4013	Vetro esterna External glass gasket	4	L/2-129
		4	H-226
AGP 4106	Vetro interna Internal glass gasket	4	L/2-129
		4	H-226
AGP 5034/25	Isolamento spalla Adjutment insulation	2	H
		2	L
TAC 804	Incontro centrale Incontro centrale	2	H-58
AGP 8005	Spazzolino Brush	4	H-58
AGP 40131	Sotto vetro Galzing strip	4	L/2-109
		4	H-206
AGP 5037	Isolamento muro Wall insulation	2	L

Art.	Descrizione	q.tà
ACP 5801	Squadretta Multifunzione Multifunction corner cleat	8
ACP 5001	Vite per ACP 5801 Screw for ACP 5801	16
ACP 50154	Squadretta Multifunzione Multifunction corner cleat	8
ACP 5030	Spina per ACP 50154 Dowel pin for ACP 50154	16
ACP 9030	Supporto vetro in alluminio Aluminium glass support	4
SA 2904 NB	Appoggio vetro 4mm 4mm glass backing	4
ACP 50110	Squadretta allineamento anta Alignment corner bracket	8
ACP 90101	Maniglione alluminio con vaschetta Handle+recessed handle	2
ACP 90112M	Asta collegamento Connection rod	2
ACP 90113M	Asta di comando Control rod	2
ACP 5036	Regolo muro metallo Metal wall spacer	18
ACP 9035M	Kit spugne Sponge kit	1
ACP 90118M	Kit base carrelli Rail base kit	2
ACP 9033M	Kit componenti plastici Plastic element kit	1
ACP 90115M	Punto di chiusura Locking point	2
ACP 8043	Paracolpo Bumper	1
ACP 9028	Cappetta scarico acqua, 2 vie Plug for water drainage, 2rails	2

Lift & side widow
3 rail / 2 sash lowered central section

Finestra scorrevole
3 vie 2 ante nodo centrale ridotto

Glass list

Distinta vetri

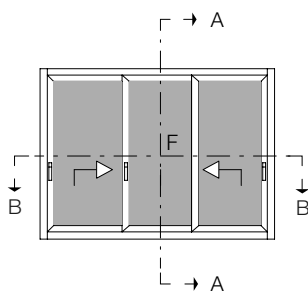

Pezzi	L	H
3	L/3-95	H-226

Sez. A-A

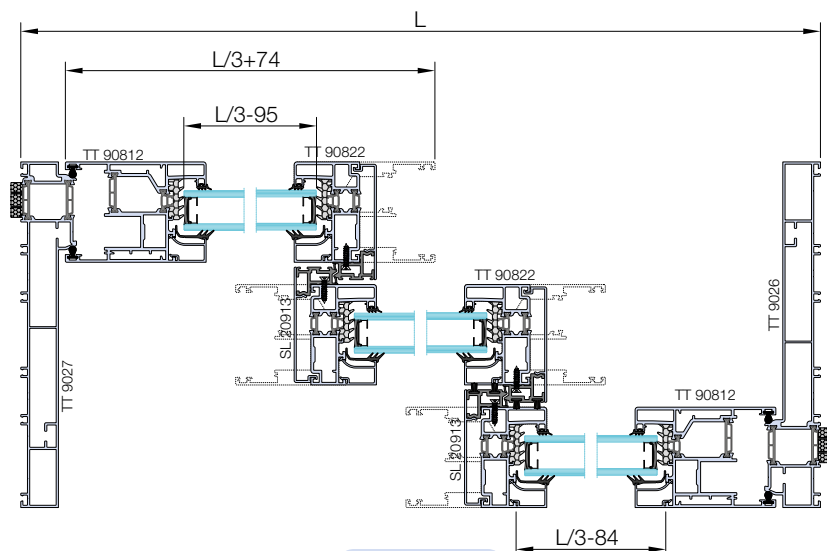

Sez. B-B

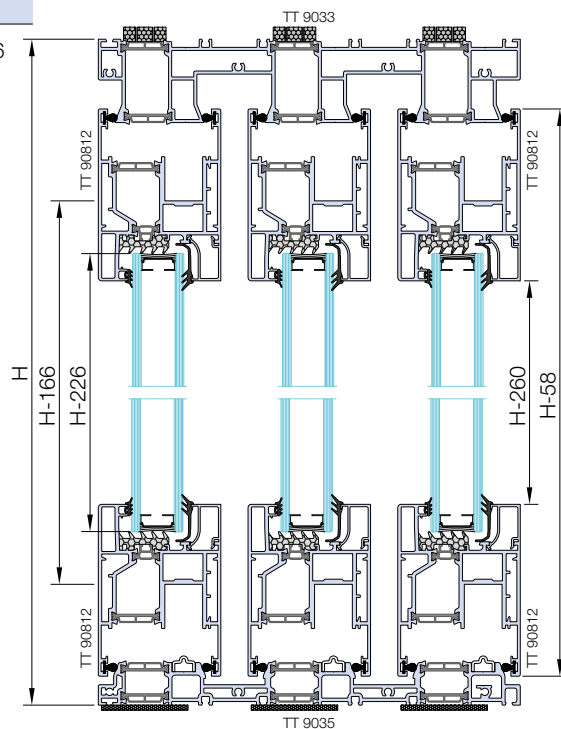

Art.	Descrizione	q.tà	Misura	Taglio
TT 9026	Montante telaio <i>Mullion frame</i>	1	H	
TT 9027	Montante telaio <i>Mullion frame</i>	1	H	
TT 90812	Traverso anta <i>Transom sash</i>	6	L/3+74	
	Montante anta <i>Mullion sash</i>	2	H-58	
SL 20913	Montante riporto centrale <i>Mullion astragal</i>	4	H-58	
TT 9035	Traverso telaio inferiore <i>Bottom transom frame</i>	1	L-58	
TT 9033	Traverso telaio superiore <i>Top transom frame</i>	1	L-58	
TT 90822	Montante anta <i>Mullion sash</i>	4	H-166	
SX 9901	Binario in inox <i>Stainless steel guide</i>	3	L-69	
PL 1418	Fermavetro <i>Glazing bead</i>	6	H-260	
		6	L/3-84	

Art.	Descrizione	q.tà
ACP 5801	Squadretta Multifunzione <i>Multifunction corner cleat</i>	12
ACP 5001	Vite per ACP 5801 <i>Screw for ACP 5801</i>	24
ACP 50154	Squadretta Multifunzione <i>Multifunction corner cleat</i>	8
ACP 5030	Spina per ACP 50154 <i>Dowel pin for ACP 50154</i>	16
ACP 9030	Supporto vetro in alluminio <i>Aluminium glass support</i>	6
SA 2904 NB	Appoggio vetro 4mm <i>4mm glass backing</i>	6
ACP 50110	Squadretta allineamento anta <i>Alignment corner bracket</i>	12
ACP 90101	Maniglione alluminio con vaschetta <i>Handle+recessed handle</i>	2
ACP 90112M	Asta collegamento <i>Connection rod</i>	2
ACP 90113M	Asta di comando <i>Control rod</i>	2
ACP 5036	Regolo muro metallo <i>Metal wall spacer</i>	18
ACP 9035M	Kit spugne <i>Sponge kit</i>	2
ACP 90118M	Kit base carrelli <i>Rail base kit</i>	2
ACP 9033M	Kit componenti plastici <i>Plastic element kit</i>	2
ACP 90115M	Punto di chiusura <i>Locking point</i>	2
ACP 8043	Paracolpo <i>Bumper</i>	2
ACP 9028	Cappetta scarico acqua, 2 vie <i>Plug for water drainage, 2rails</i>	2
ACP 9034	Cappetta scarico acqua, 3 vie <i>Plug for water drainage, 3 rails</i>	2
ACP 9036	Distanziale per anta fissa <i>Spacer for fixed leaf</i>	2

Art.	Descrizione	q.tà	Misura
AGP 9005	Battuta <i>Rabbit gasket</i>	12	L/3+74
		4	H-58
AGP 4013	Vetro esterna <i>External glass gasket</i>	6	L/3-95
		6	H-226
AGP 4106	Vetro interna <i>Internal glass gasket</i>	6	L/3-95
		6	H226
AGP 5034/25	Isolamento spalla <i>Abutment insulation</i>	2	H
		3	L
TAC 804	Incontro centrale <i>Incontro centrale</i>	4	H-58
AGP 8005	Spazzolino <i>Brush</i>	8	H-58
AGP 40131	Sotto vetro <i>Galzing strip</i>	6	L/3-74
		6	H-226
AGP 5037	Isolamento muro <i>Wall insulation</i>	3	L

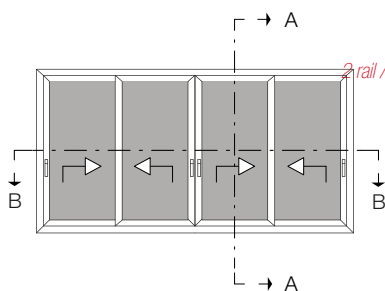

Lift & side window
2 rail / 4 sash lowered central section
Glass list

Finestra scorrevole
2 vie 4 ante nodo centrale ridotto
Distinta vetri

Pezzi	L	H
4	L/4-114	H-226

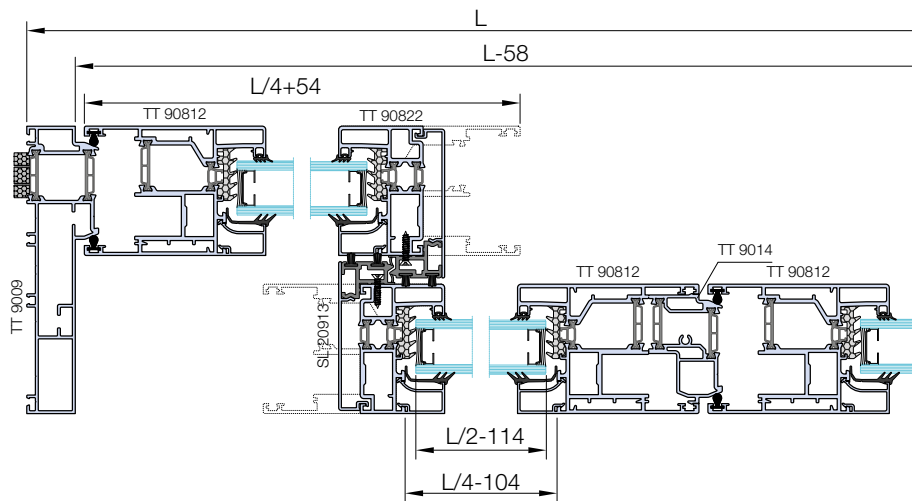

Sez. B-B

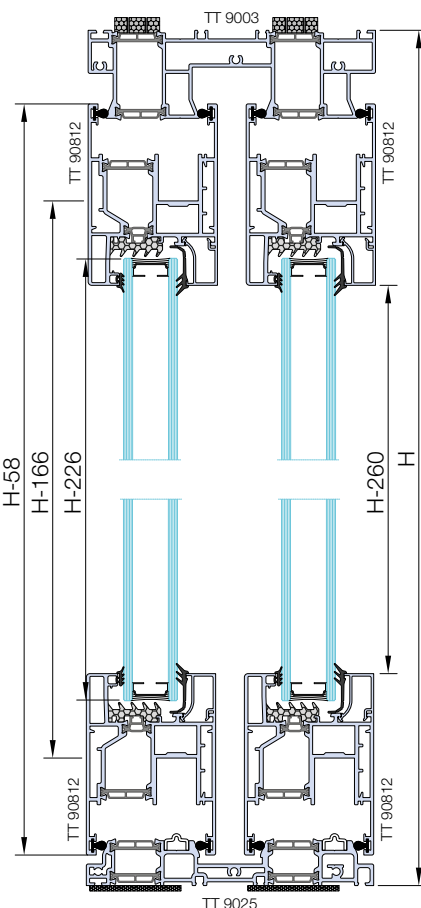

Sez. A-A

Art.	Descrizione	q.tà	Misura	Taglio
TT 9009	Montante telaio <i>Mullion frame</i>	2	H	
TT 9025	Traverso telaio inferiore <i>Bottom transom frame</i>	1	L-58	
TT 90812	Traverso anta <i>Transom sash</i>	8	L/4+54	
	Montante anta <i>Mullion sash</i>	4	H-58	
SL 20913	Montante riporto centrale <i>Mullion astragal</i>	4	H-58	
TT 9014	Incontro ante <i>Closure profile</i>	1	H-104	
TT 90822	Montante anta <i>Mullion sash</i>	4	H-166	
TT 9003	Traverso telaio superiore <i>Top transom frame</i>	1	L-58	
SX 9901	Binario in inox <i>Stainless steel guide</i>	2	L-69	
PL 1418	Fermavetro <i>Glazing bead</i>	8	L/4-104	
		8	H-260	

Art.	Descrizione	q.tà	Misura
AGP 9005	Battuta <i>Rabbit gasket</i>	6	H-58
AGP 4014	Vetro esterna <i>External glass gasket</i>	8	L/4-114
AGP 4106	Vetro interna <i>Internal glass gasket</i>	8	L/4-114
AGP 5034/25	Isolamento spalla <i>Abutment insulation</i>	2	H
TAC 804	Incontro centrale <i>Incontro centrale</i>	4	H-58
AGP 8005	Spazzolino <i>Brush</i>	8	H-58
AGP 40131	Sotto vetro <i>Galzing strip</i>	8	L/4-94
AGP 5037	Isolamento muro <i>Wall insulation</i>	2	L

Art.	Descrizione	q.tà
ACP 5801	Squadretta Multifunzione <i>Multifunction corner cleat</i>	16
ACP 5001	Vite per ACP 5801 <i>Screw for ACP 5801</i>	32
ACP 50154	Squadretta Multifunzione <i>Multifunction corner cleat</i>	16
ACP 5030	Spina per ACP 50154 <i>Dowel pin for ACP 50154</i>	32
ACP 9030	Supporto vetro in alluminio <i>Aluminium glass support</i>	8
SA 2904 NB	Appoggio vetro 4mm <i>4mm glass backing</i>	8
ACP 50110	Squadretta allineamento anta <i>Alignment corner bracket</i>	16
ACP 90101	Maniglione alluminio con vaschetta <i>Handle+recessed handle</i>	4
ACP 90112M	Asta collegamento <i>Connection rod</i>	4
ACP 90113M	Asta di comando <i>Control rod</i>	4
ACP 5036	Regolo muro metallo <i>Metal wall spacer</i>	20
ACP 9035M	Kit spugne <i>Sponge kit</i>	2
ACP 90118M	Kit base carrelli <i>Rail base kit</i>	4
ACP 9033M	Kit componenti plastici <i>Plastic element kit</i>	2
ACP 90115M	Punto di chiusura <i>Locking point</i>	3
ACP 8043	Paracolpo <i>Bumper</i>	4
ACP 9028	Cappetta scarico acqua, 2 vie <i>Plug for water drainage, 2rails</i>	4
ACP 9029	Tappi ante frontali <i>Plug for frontal sash</i>	1 cp.

Nodo 01

Nodo superiore

Upper node

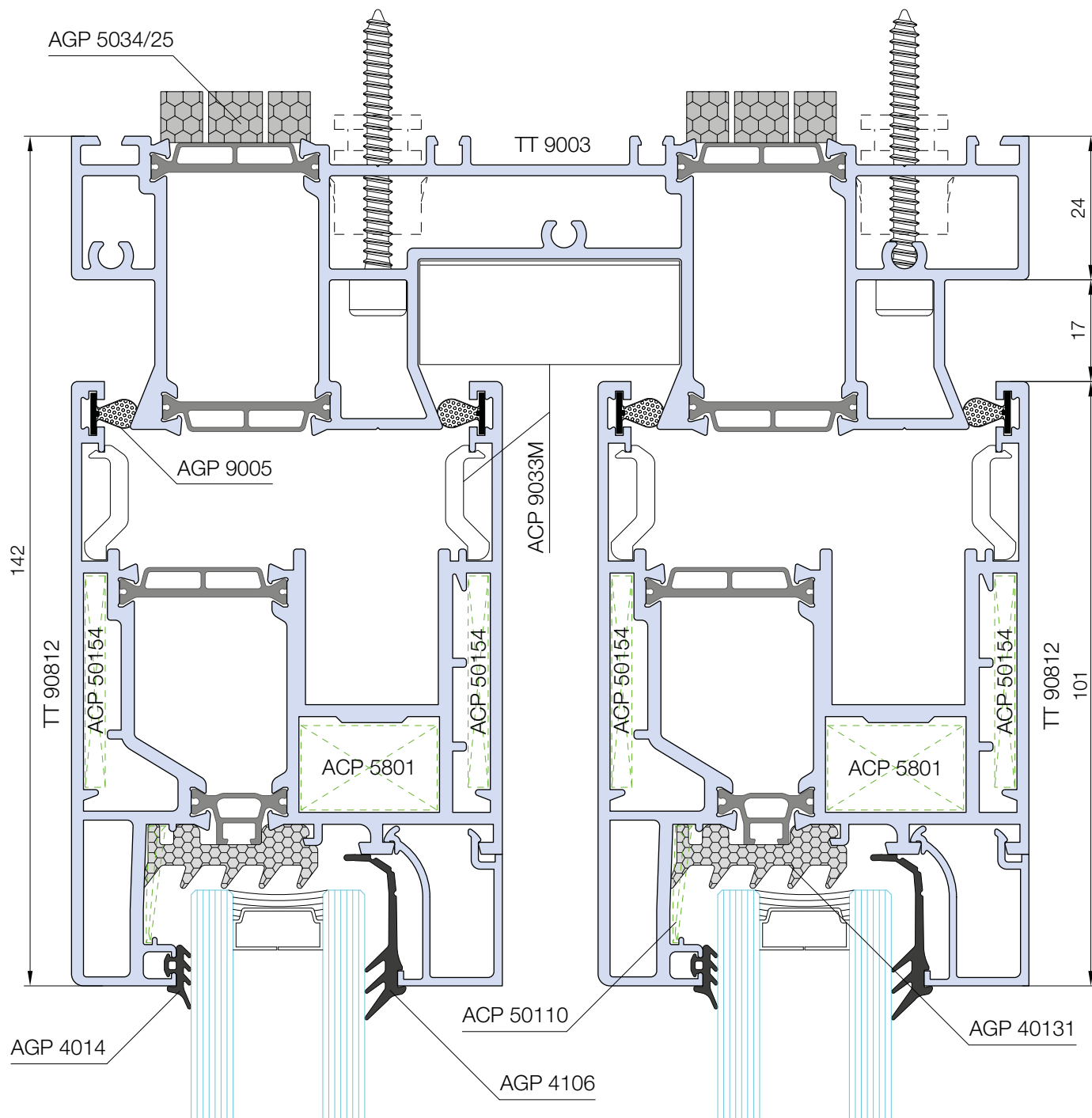

Nodo 02

Nodo inferiore

Lower node

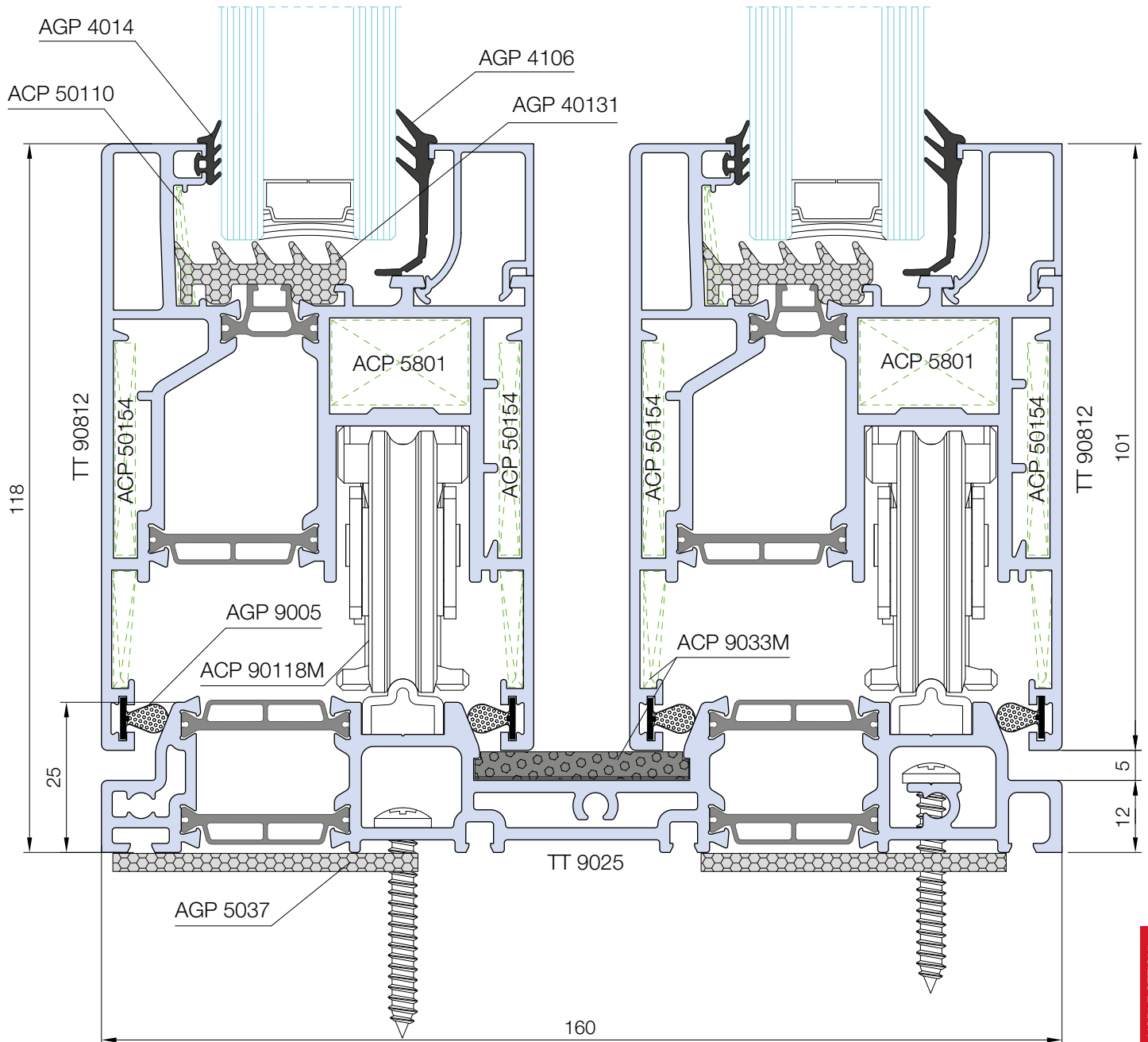

Nodo 03

Nodo superiore

Upper node

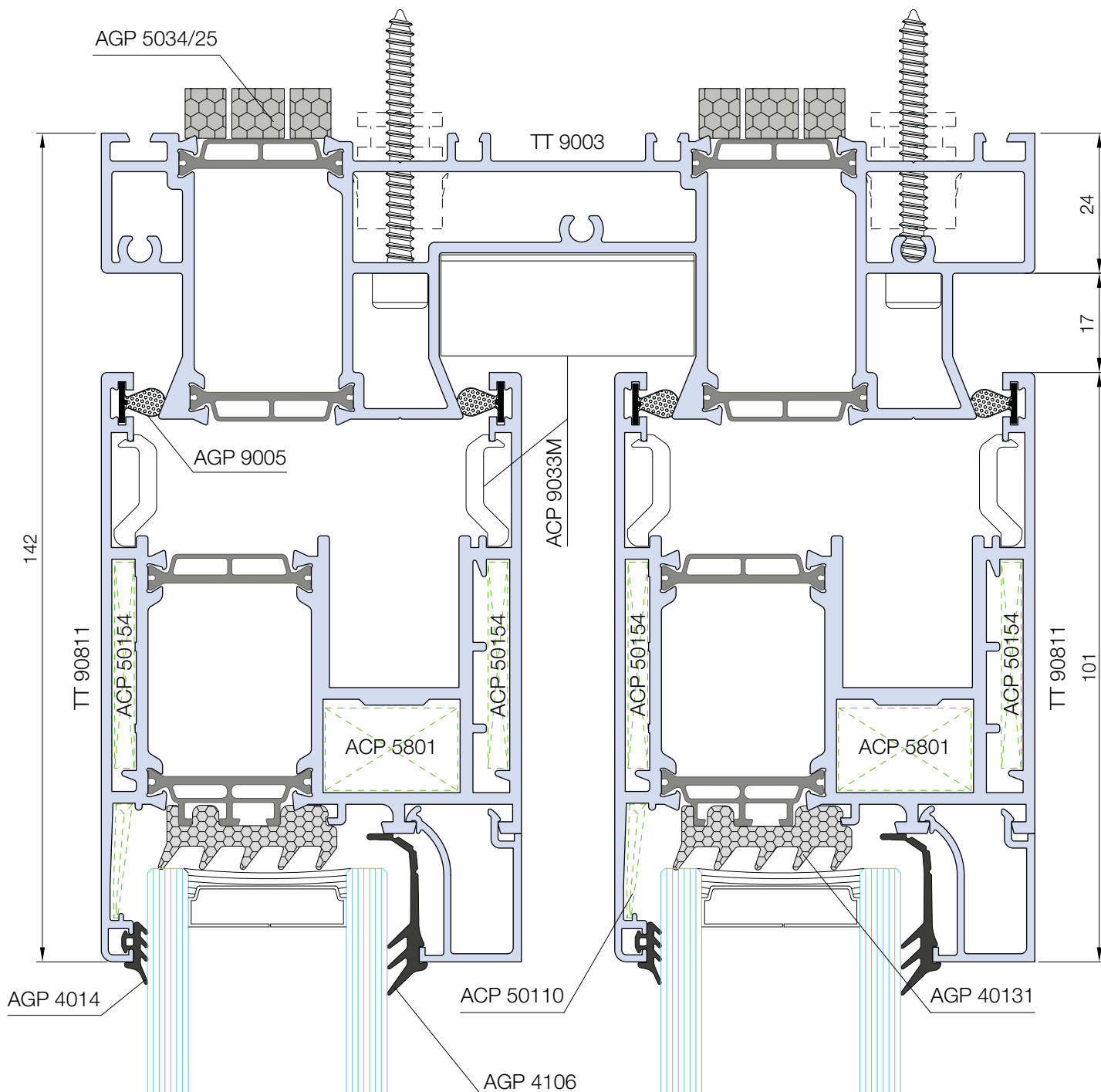

Nodo 04

Nodo inferiore
Lower node

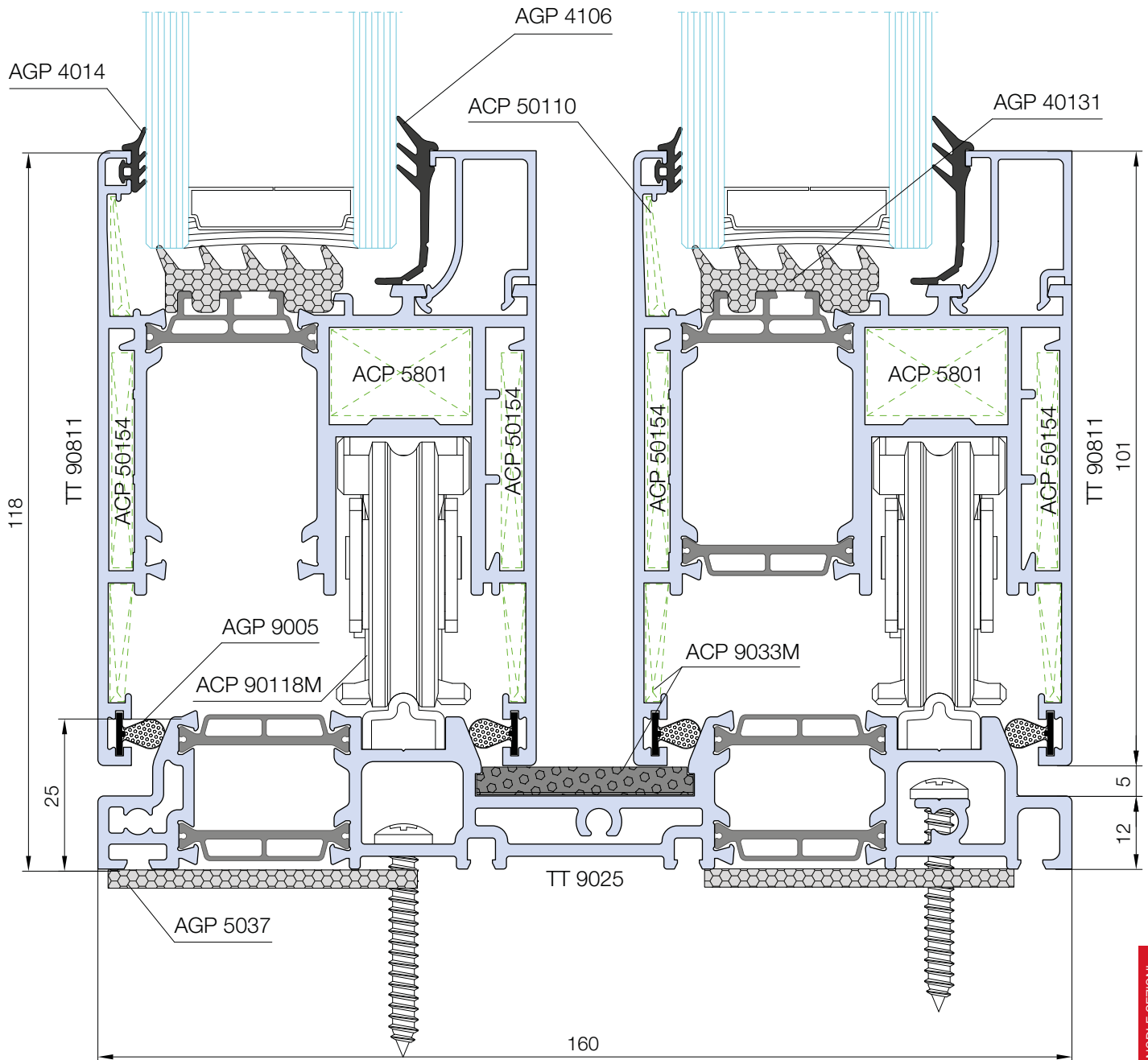

Nodo 05

Nodo laterale esterno

External lateral section

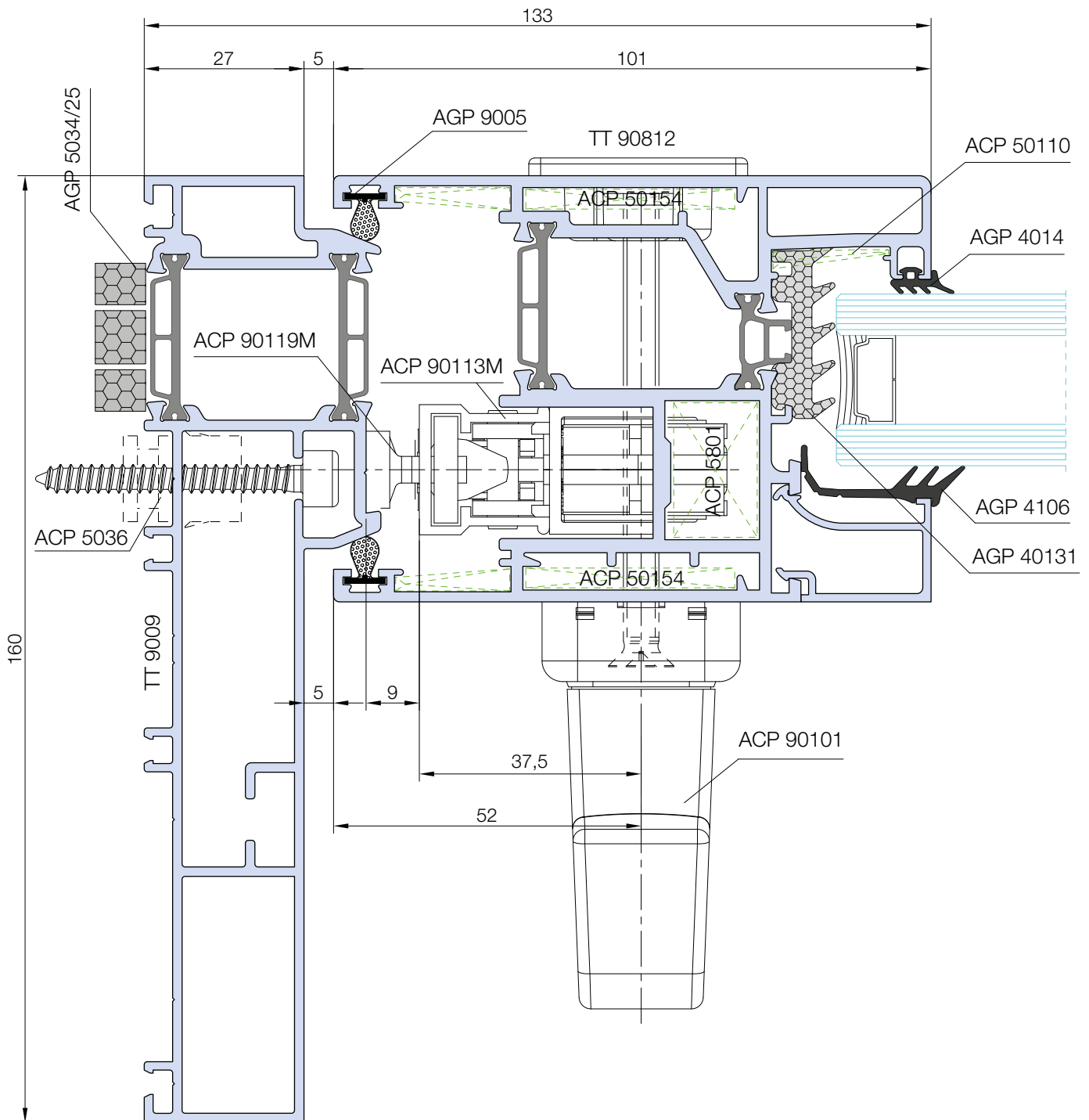

Nodo 06

Nodo laterale interno

Inner Lateral section

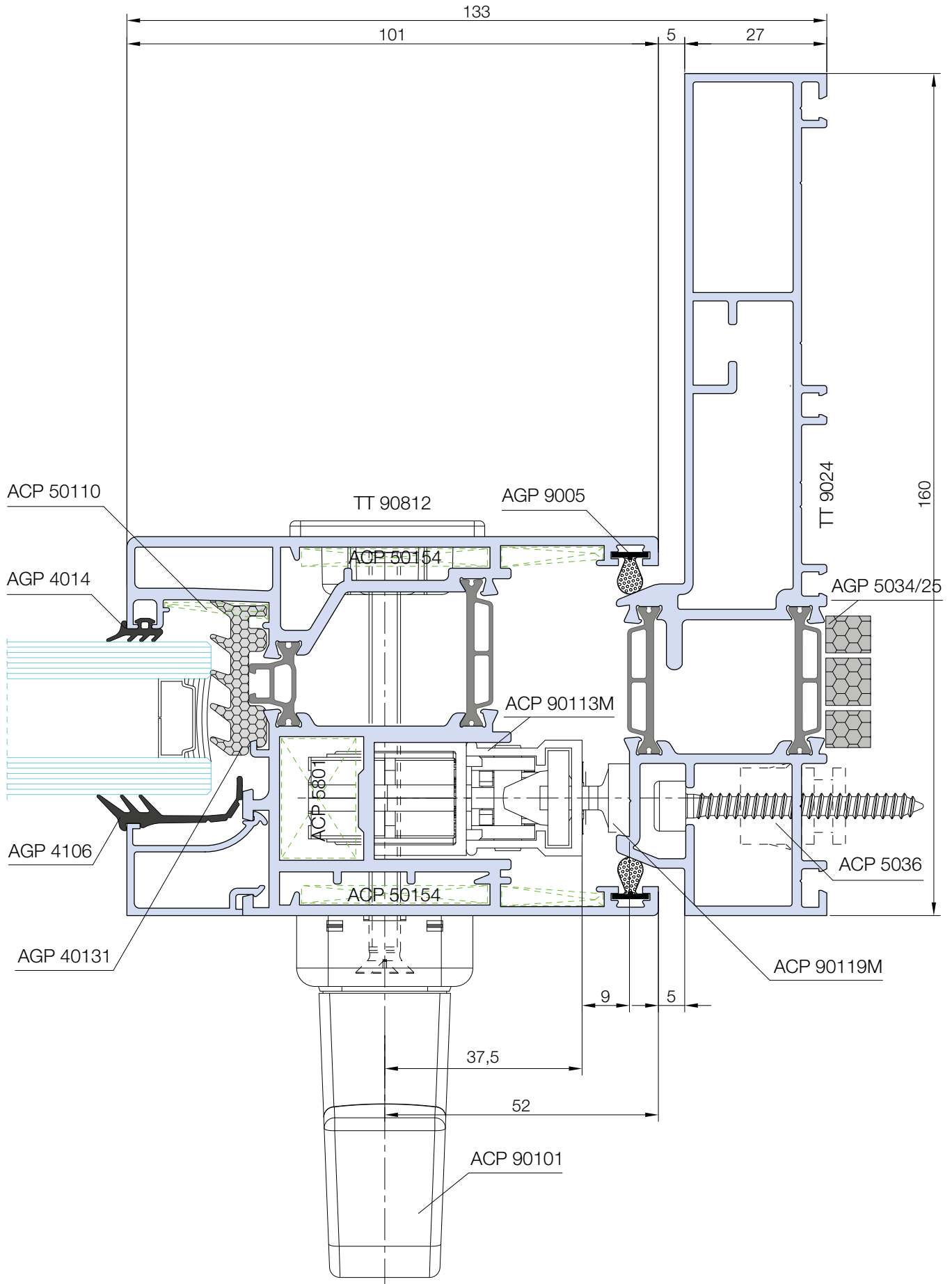

Nodo 07

Nodo laterale esterno

External lateral section

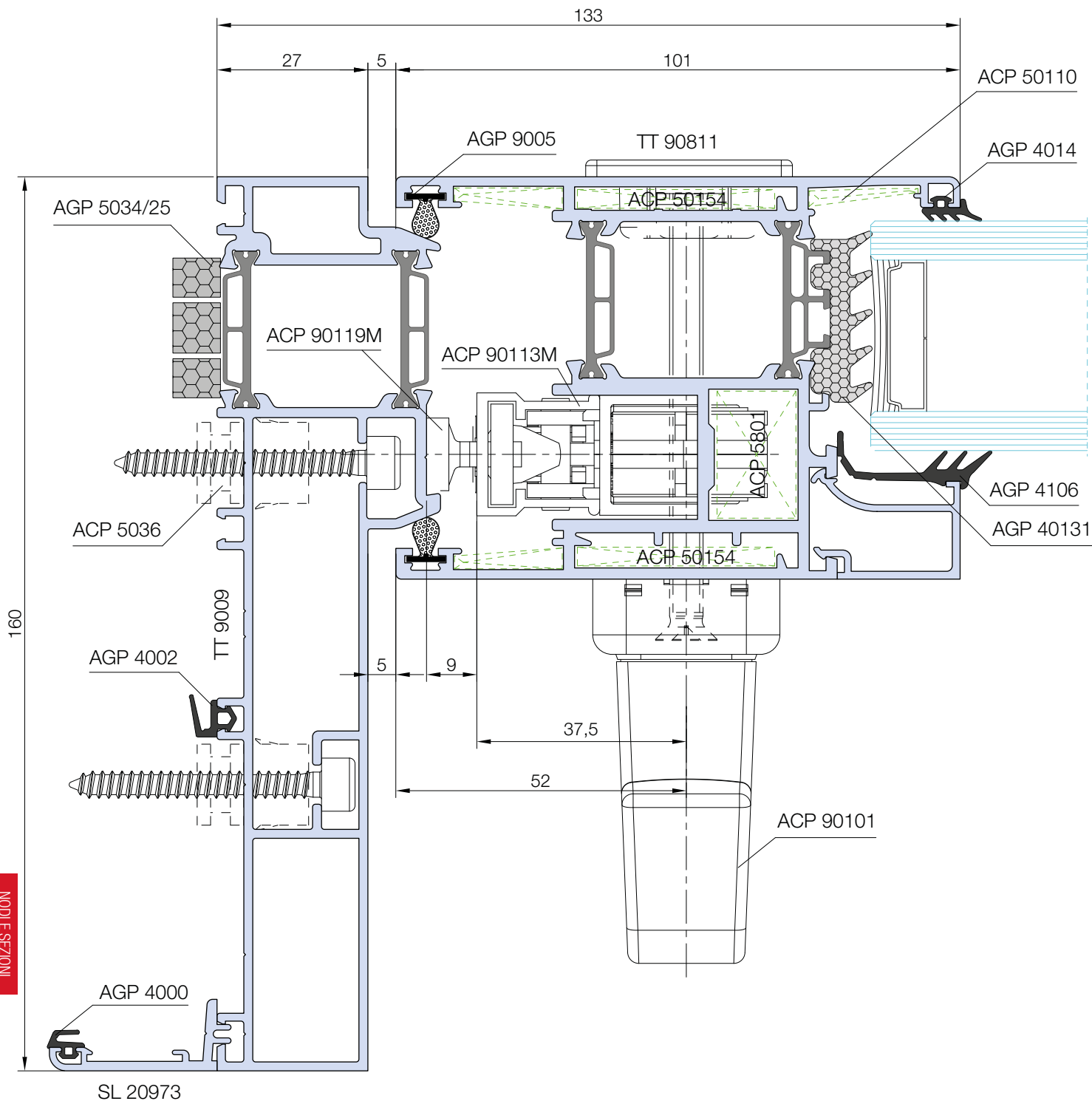

Nodi e sezioni
Sections

Nodo 08

Nodo laterale interno

Inner lateral section

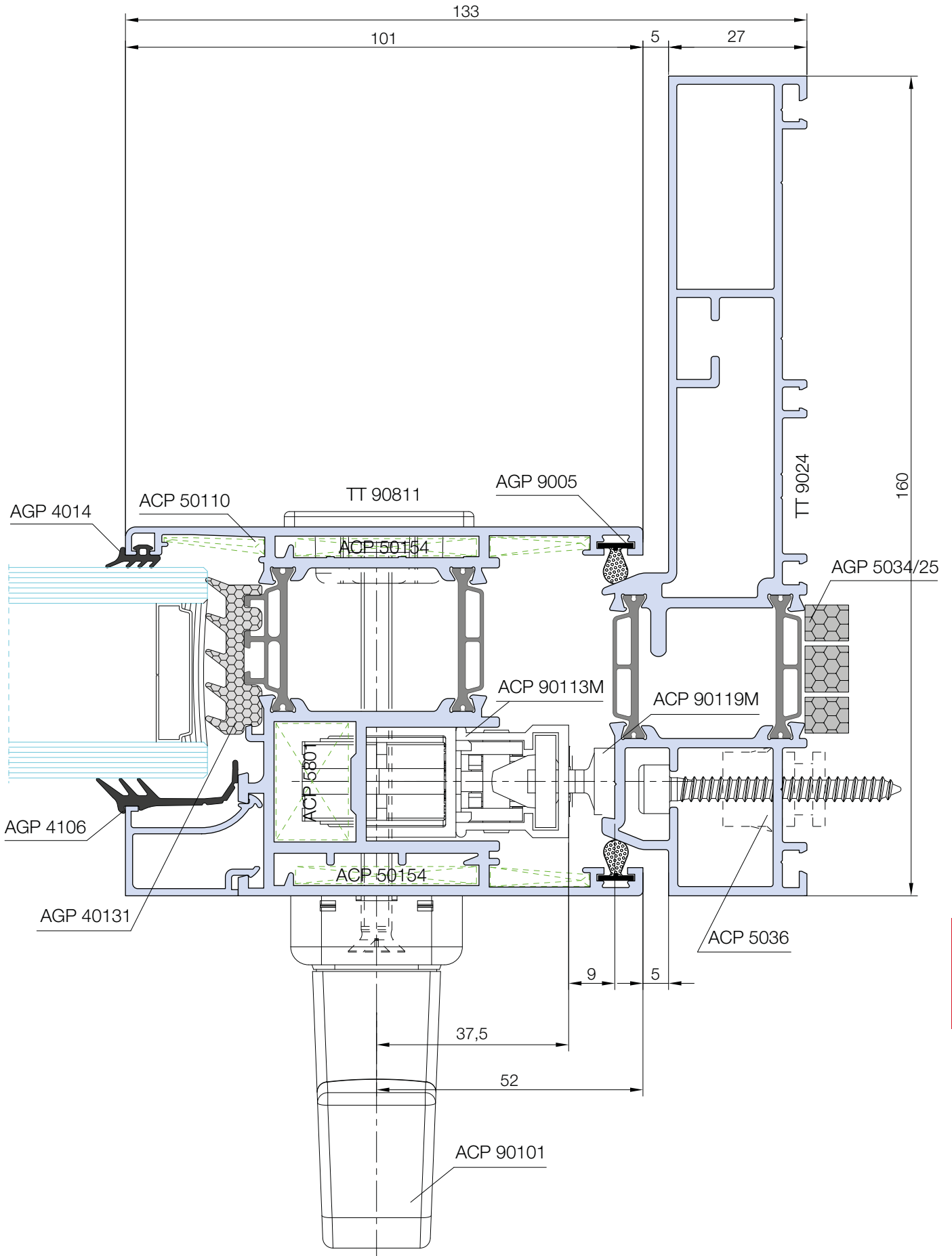

Nodo 09

Nodo laterale esterno - anta fissa

External lateral section - fixed sash

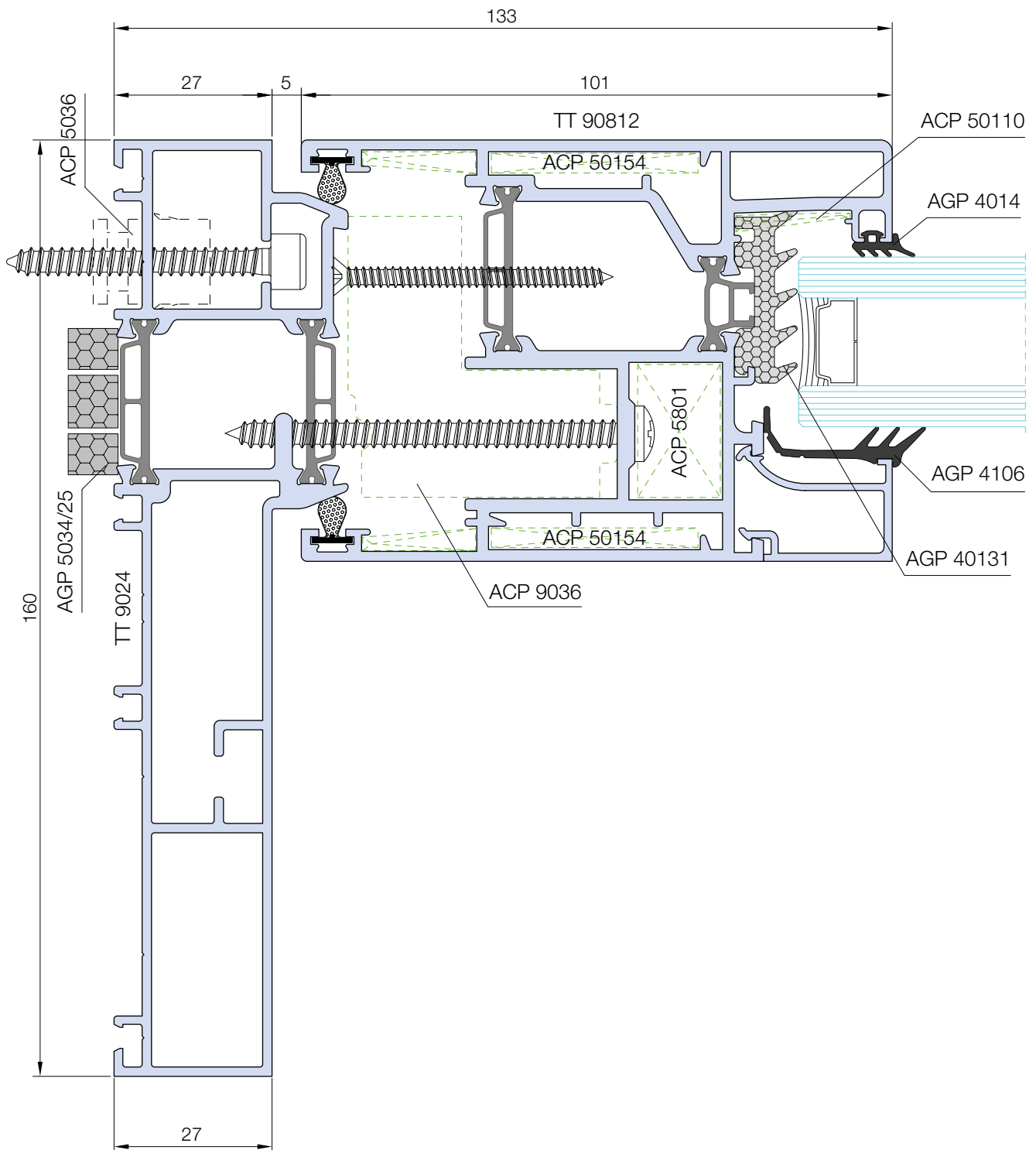

Nodo 10

Nodo centrale

Central section

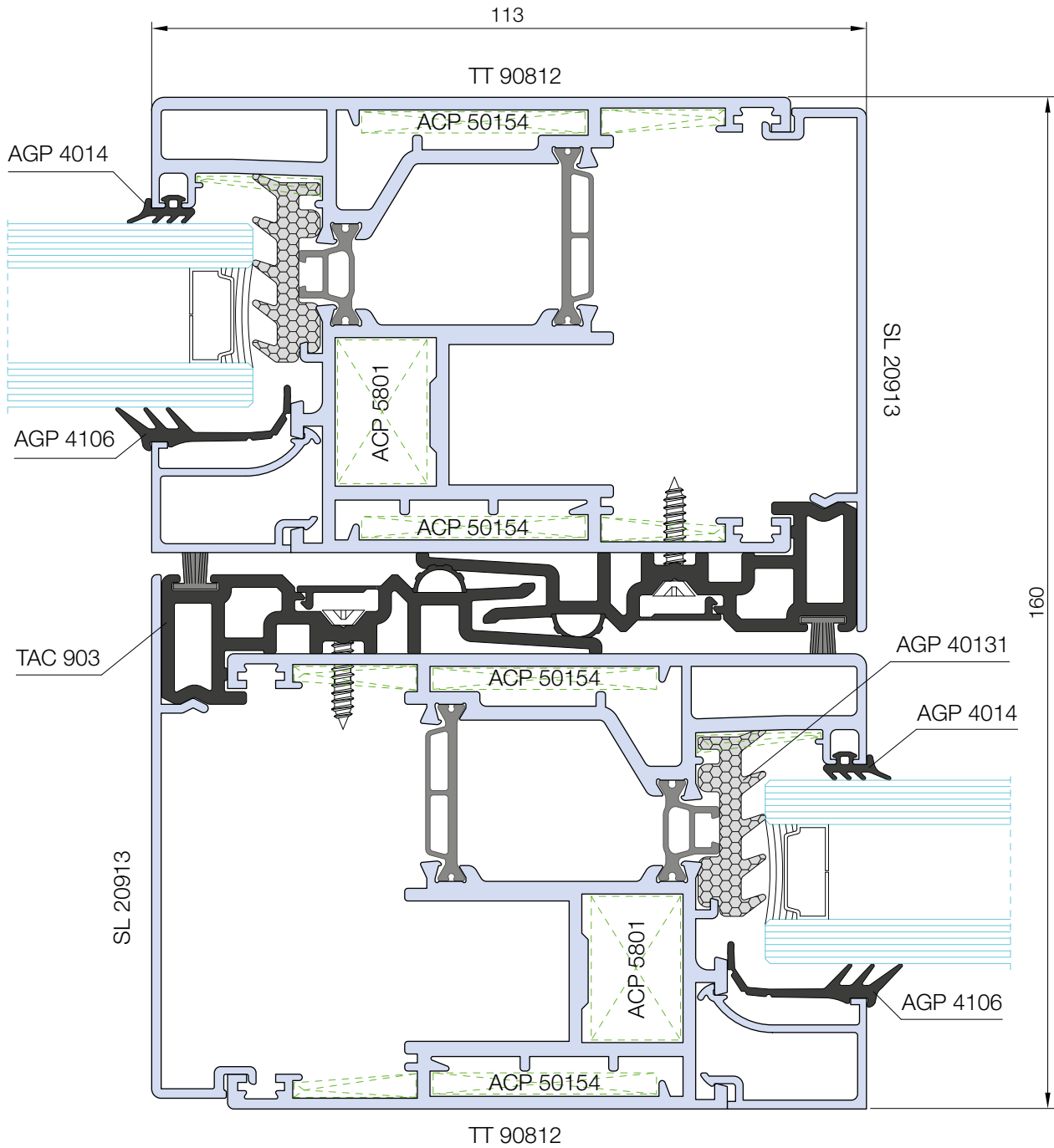

Nodo 11

Nodo centrale

Central section

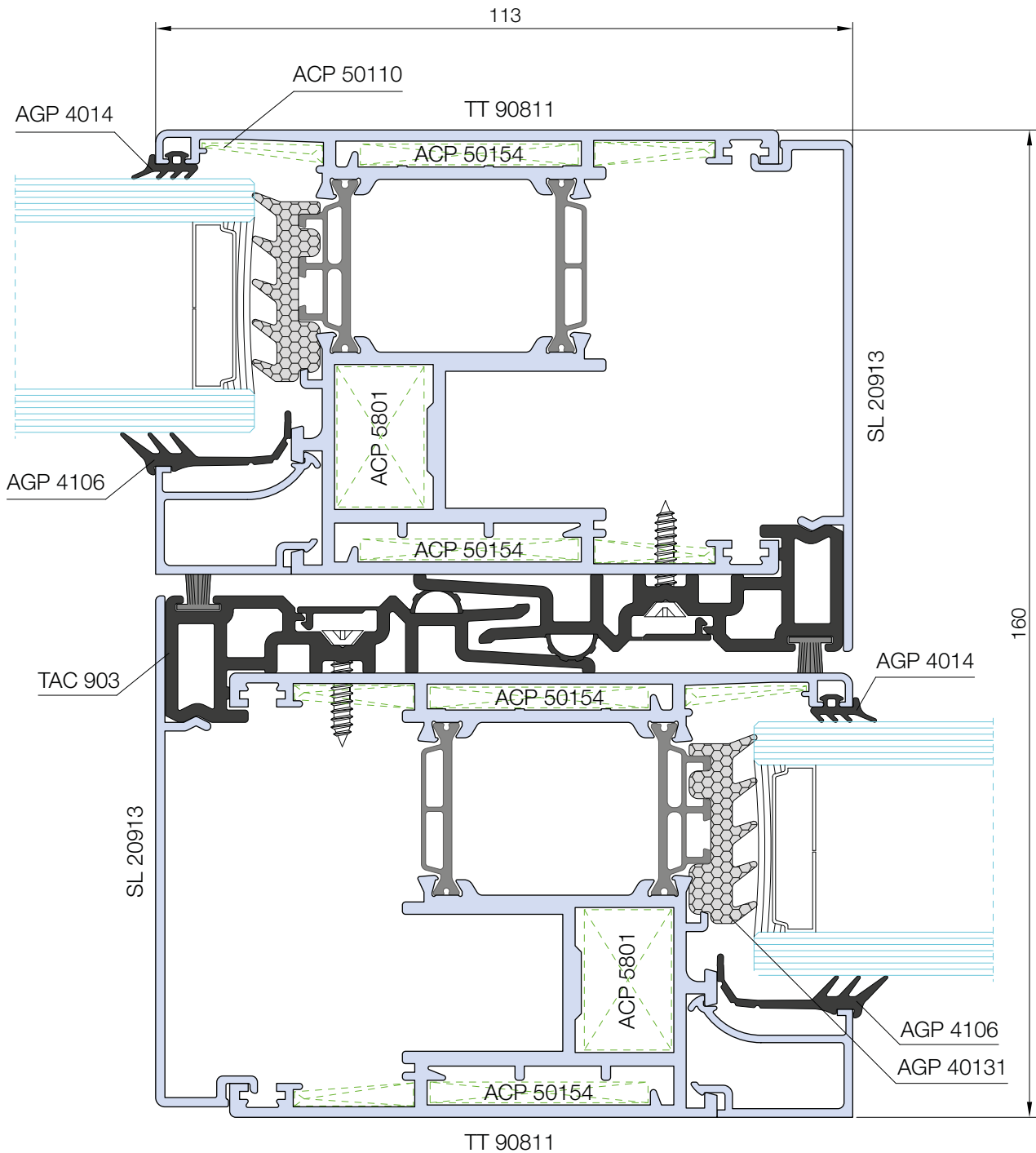

Nodo 12

Nodo centrale - ante frontali

Central section - frontal sash

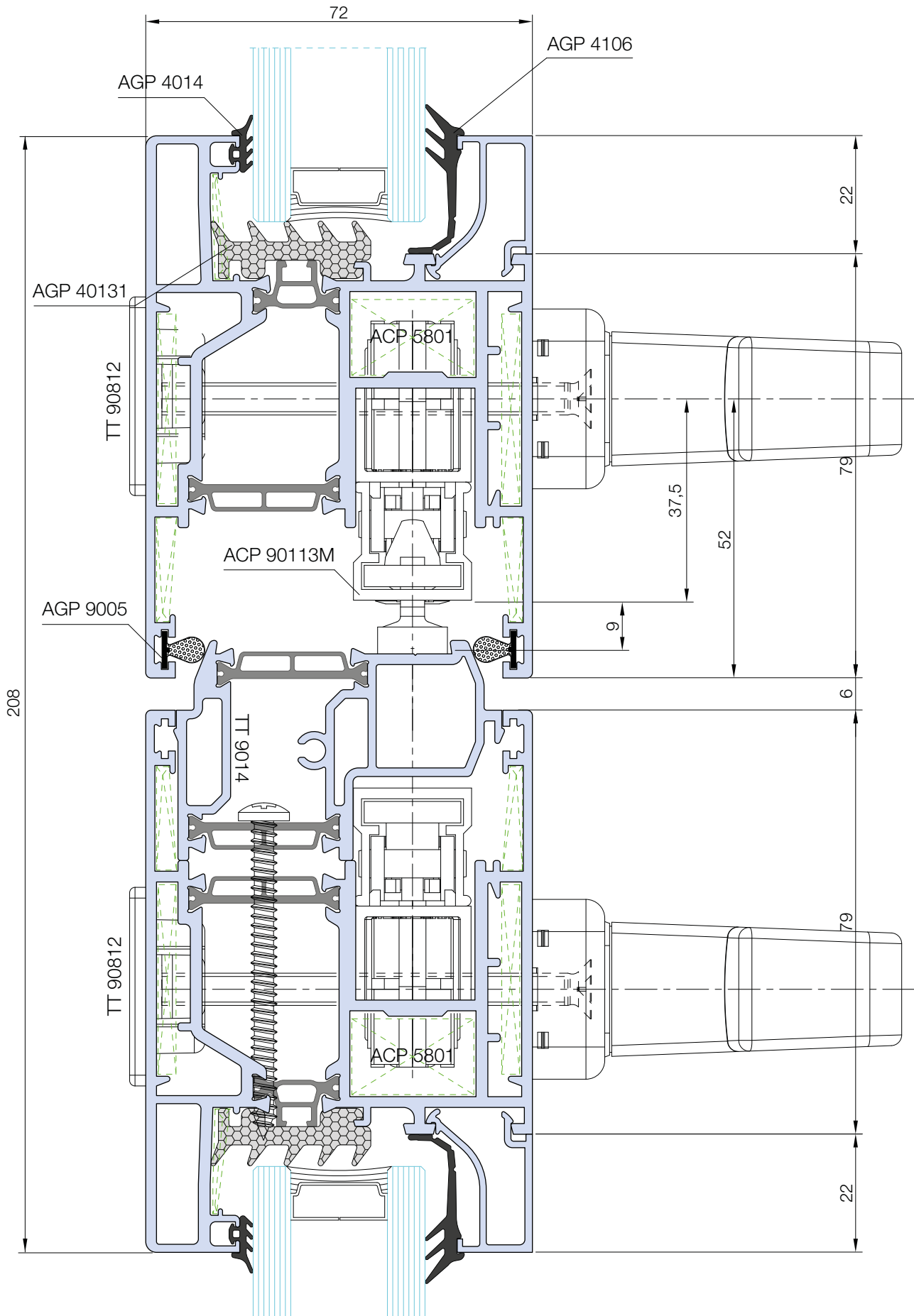

Nodo 13

Nodo superiore - monovia

Upper node - 1 rail

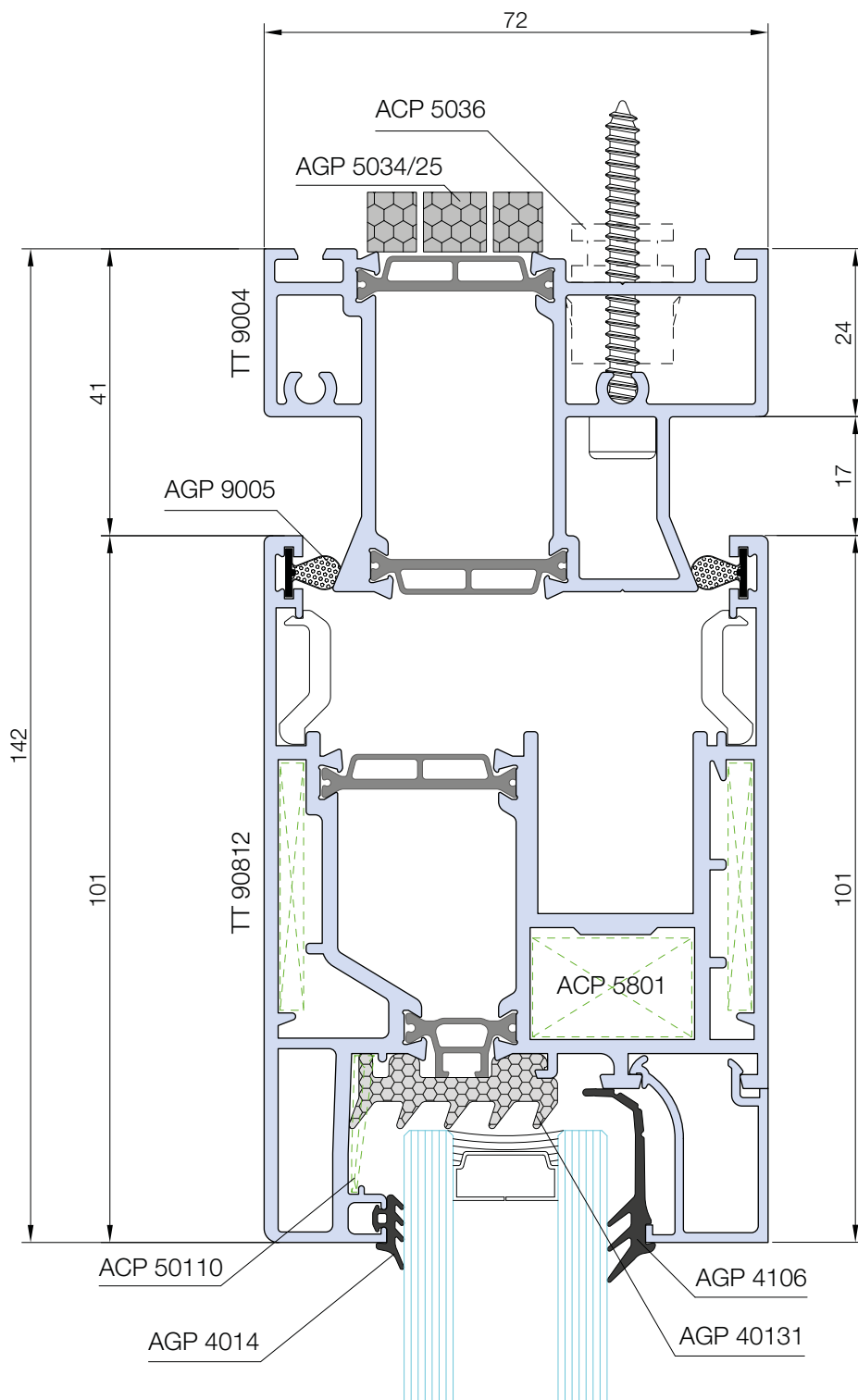

Nodo 14

Nodo inferiore - monovia

Lower node - 1 rail

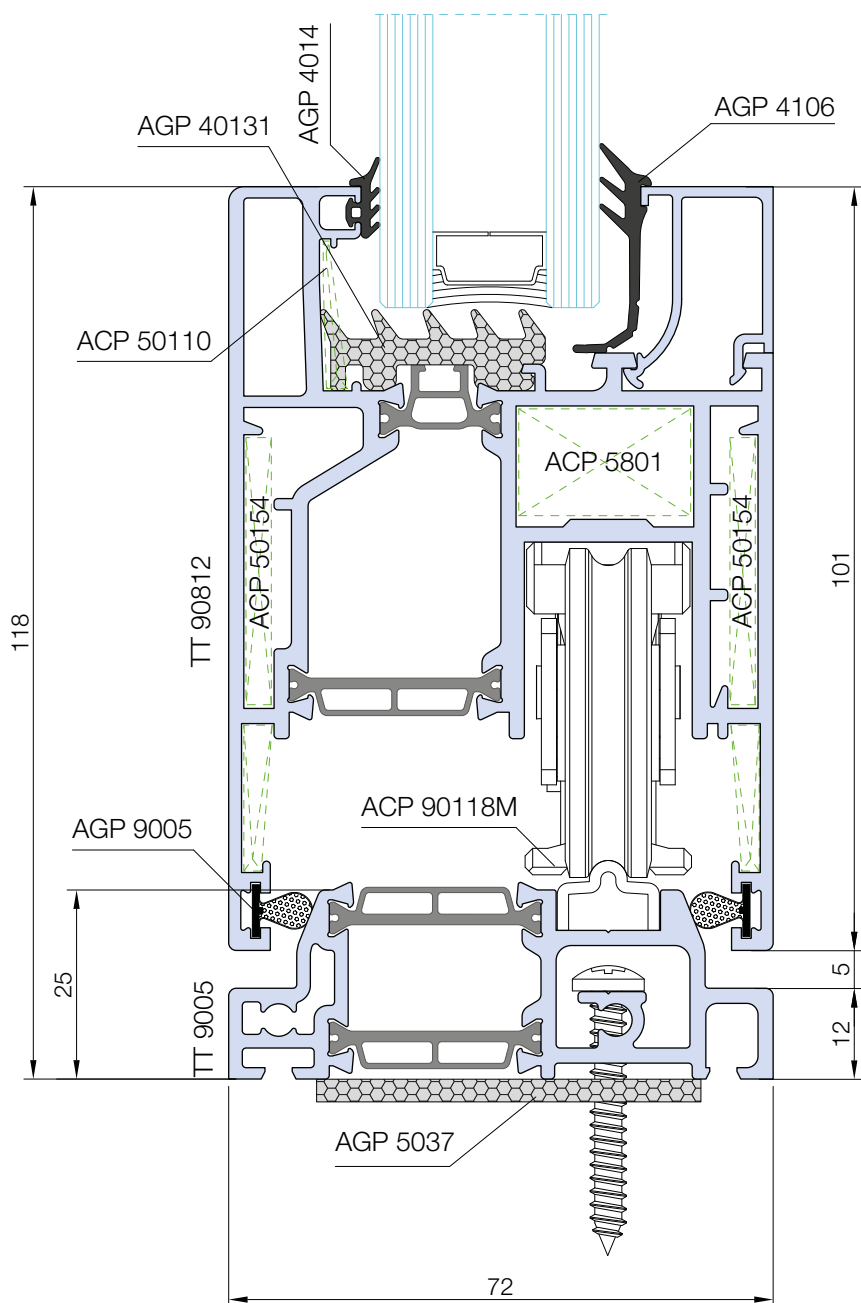

Nodo 15

Nodo a muro - monovia

Wall section - 1 rail

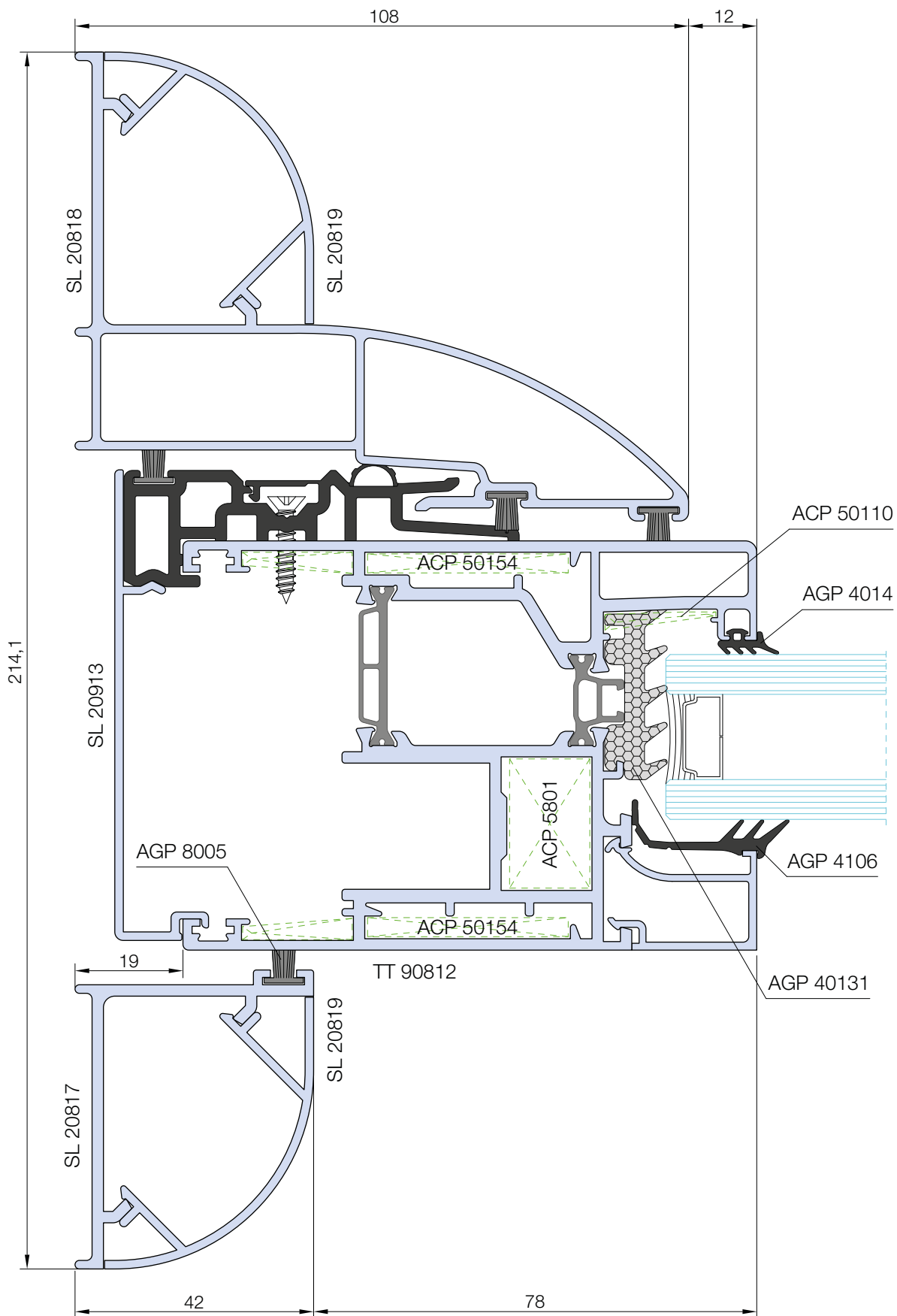

Nodo 16

Nodo a muro - monovia

Wall section - 1 rail

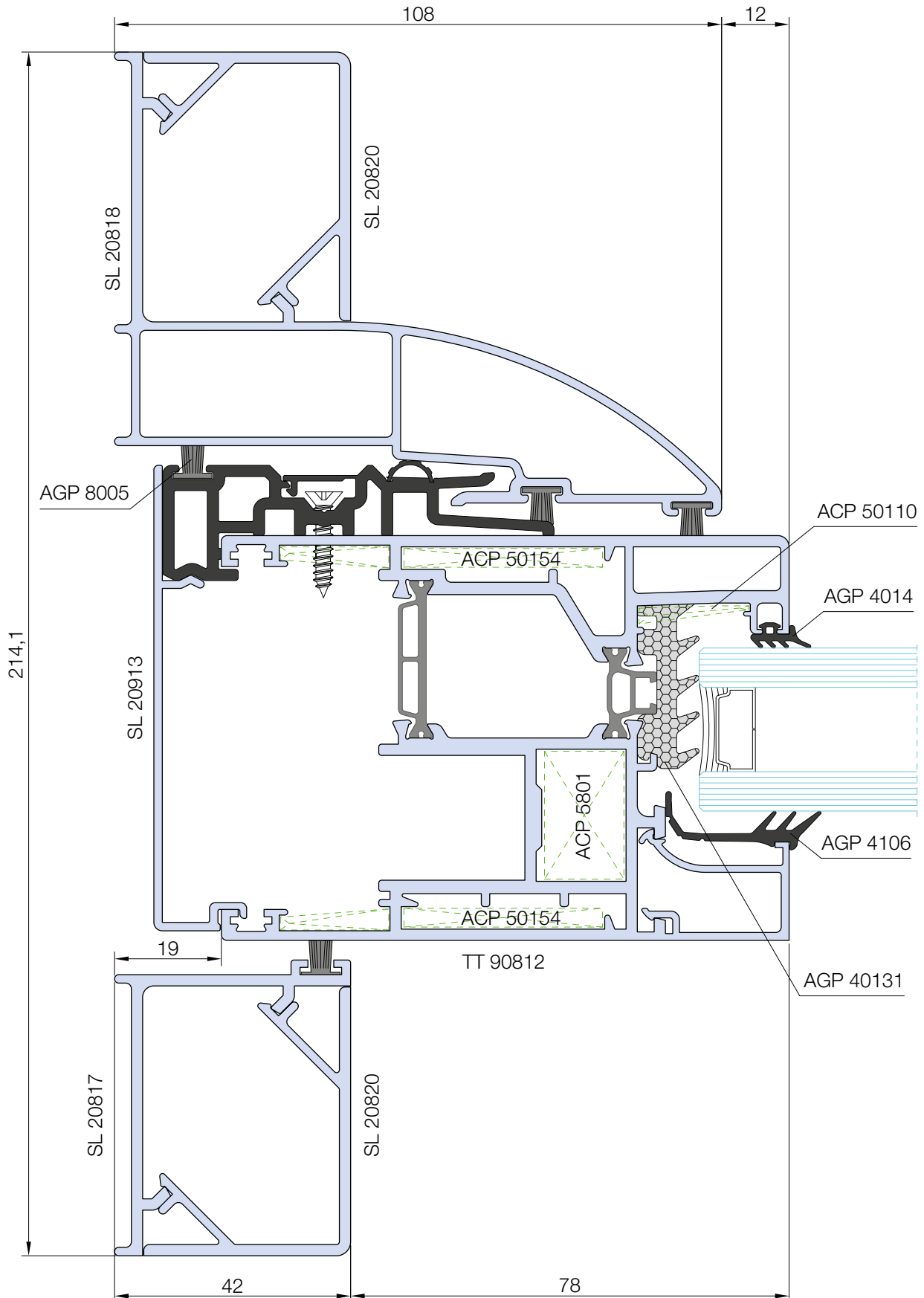

Nodo 17

Nodo laterale - monovia

Lateral section - 1 rail

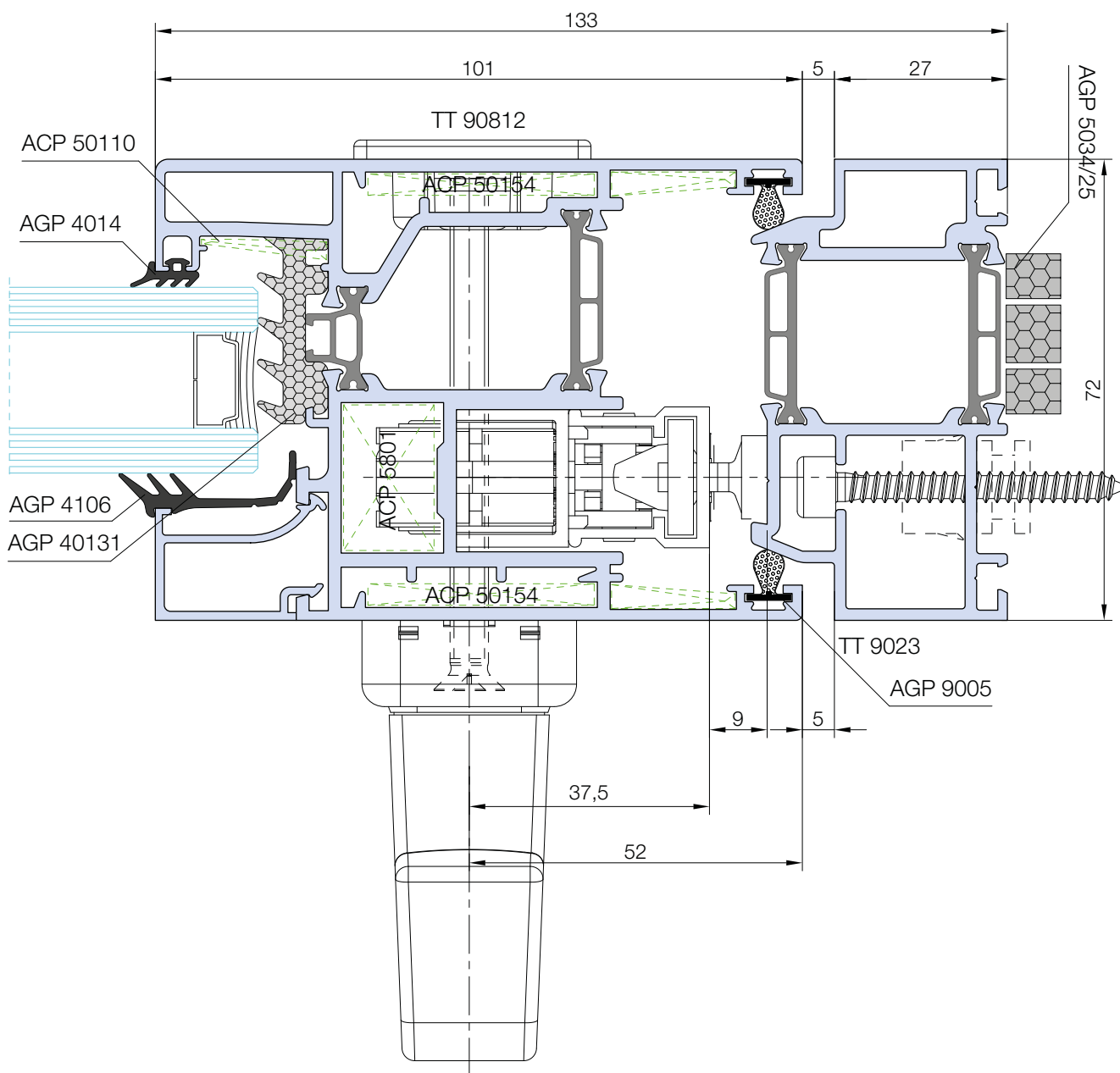

Nodo 18

Nodo superiore - monovia - fisso superiore

Upper section+top fixed - 1 rail

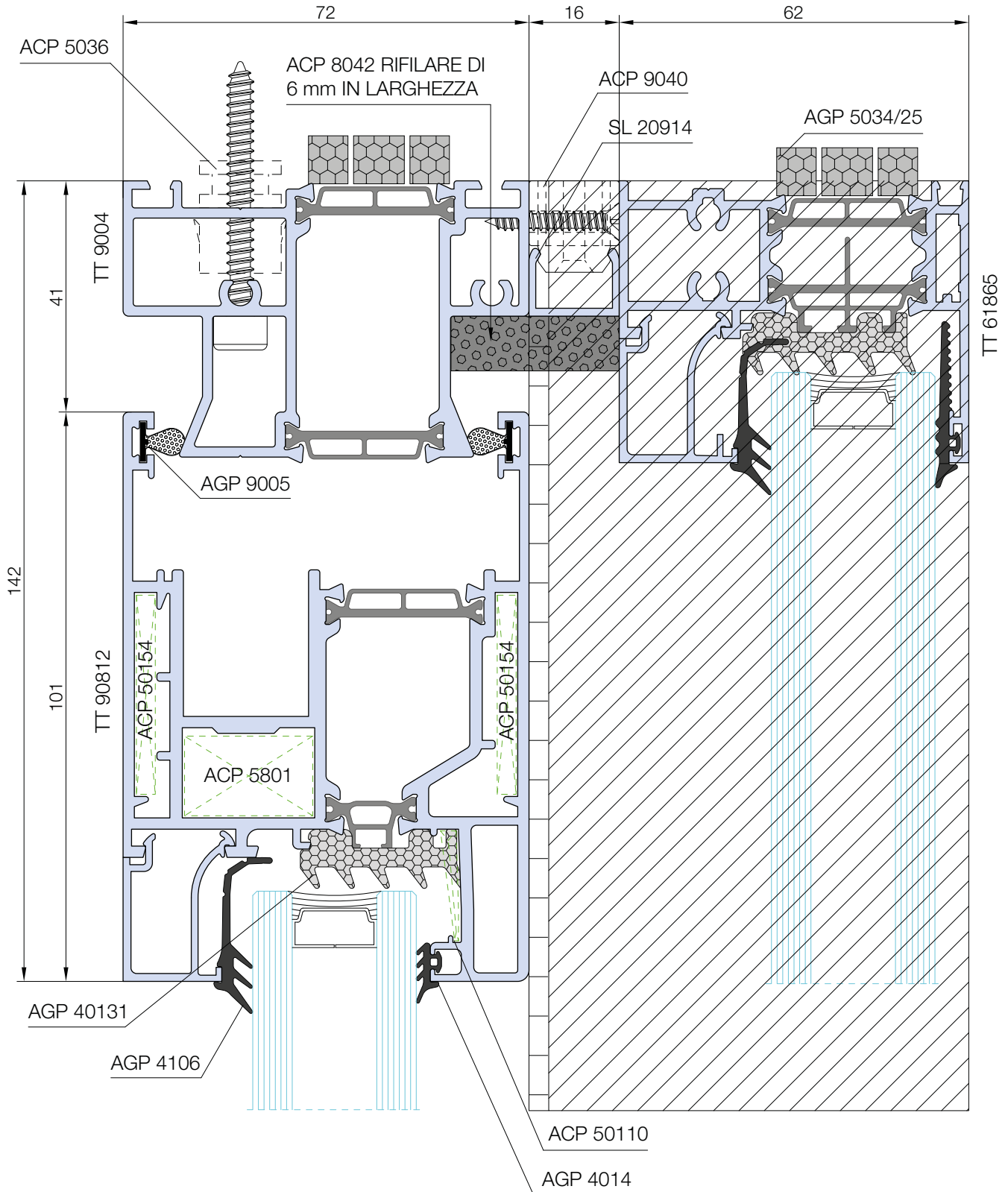

Nodo 19

Nodo inferiore - monovia - fisso laterale

Lower section - lateral fixed - 1 rail

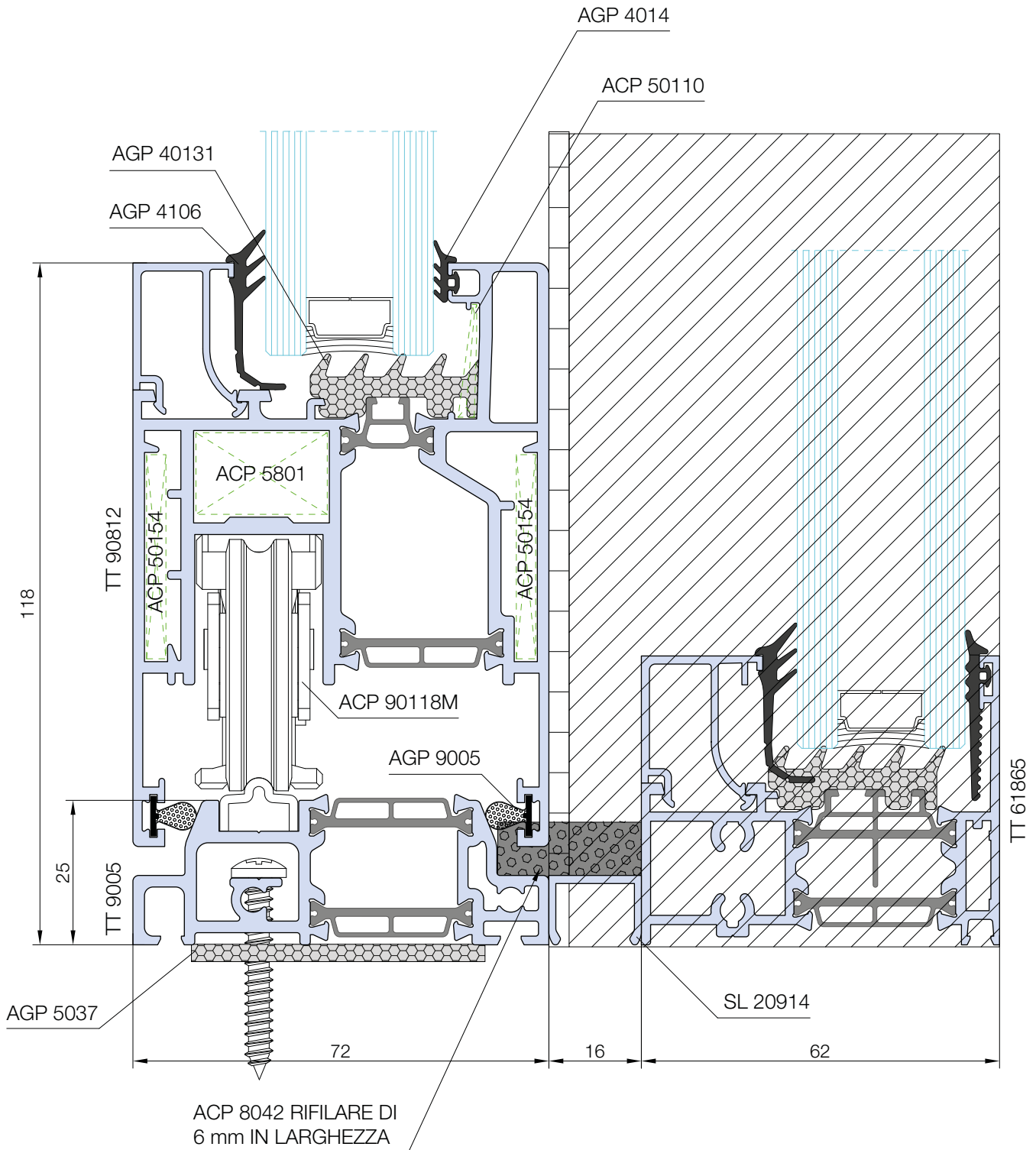

Nodo 20

Nodo a muro- monovia - fisso laterale

Wall section - lateral fixed - 1 rail

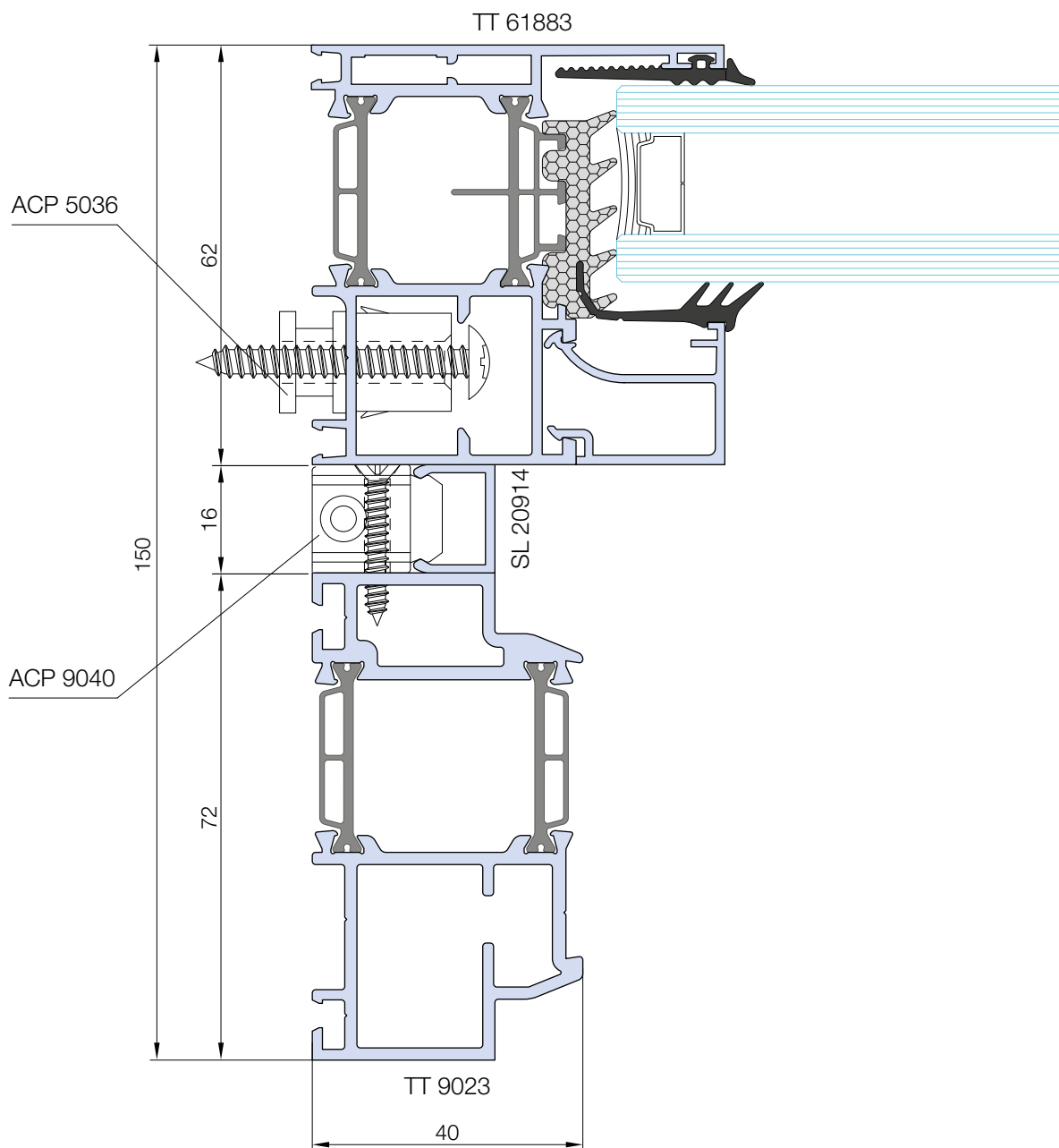

Nodo 21

Nodo centrale- monovia - fisso laterale

Central section - lateral fixed - 1 rail

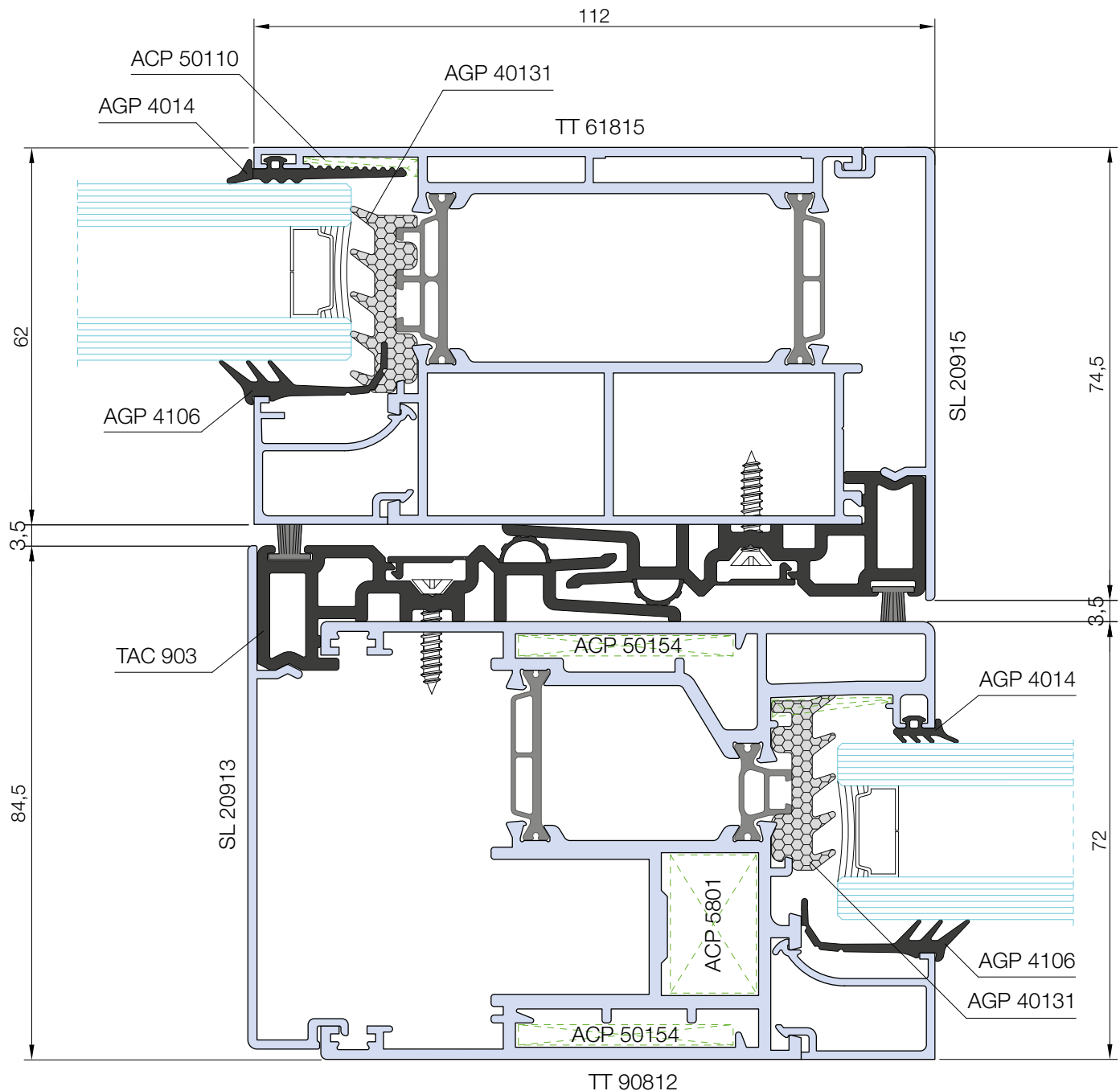

Nodo 22

Nodo superiore - 3 vie

Upper section - 3 rail

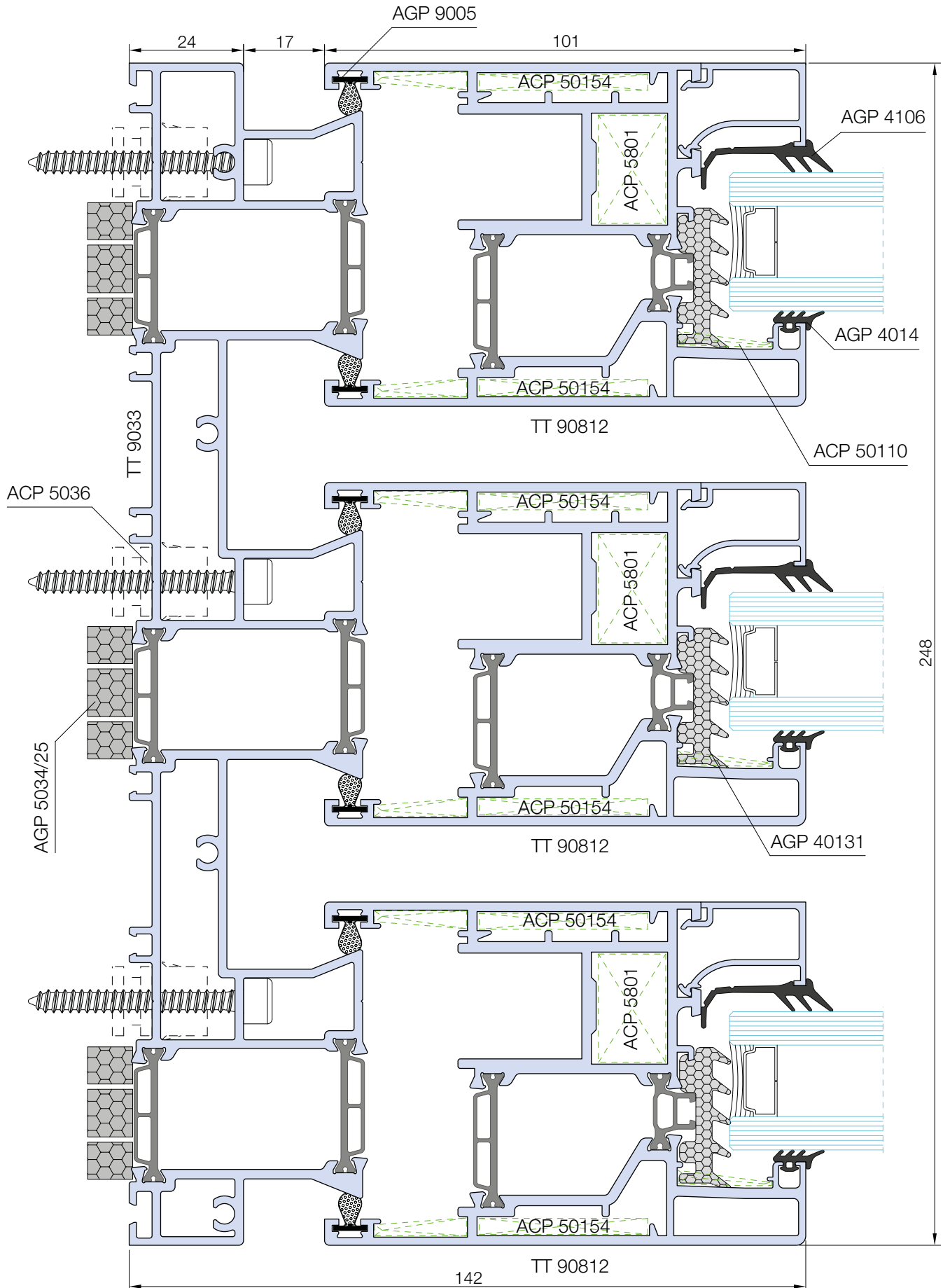

Nodo 23

Nodo inferiore - 3 vie

Lower section - 3 rail

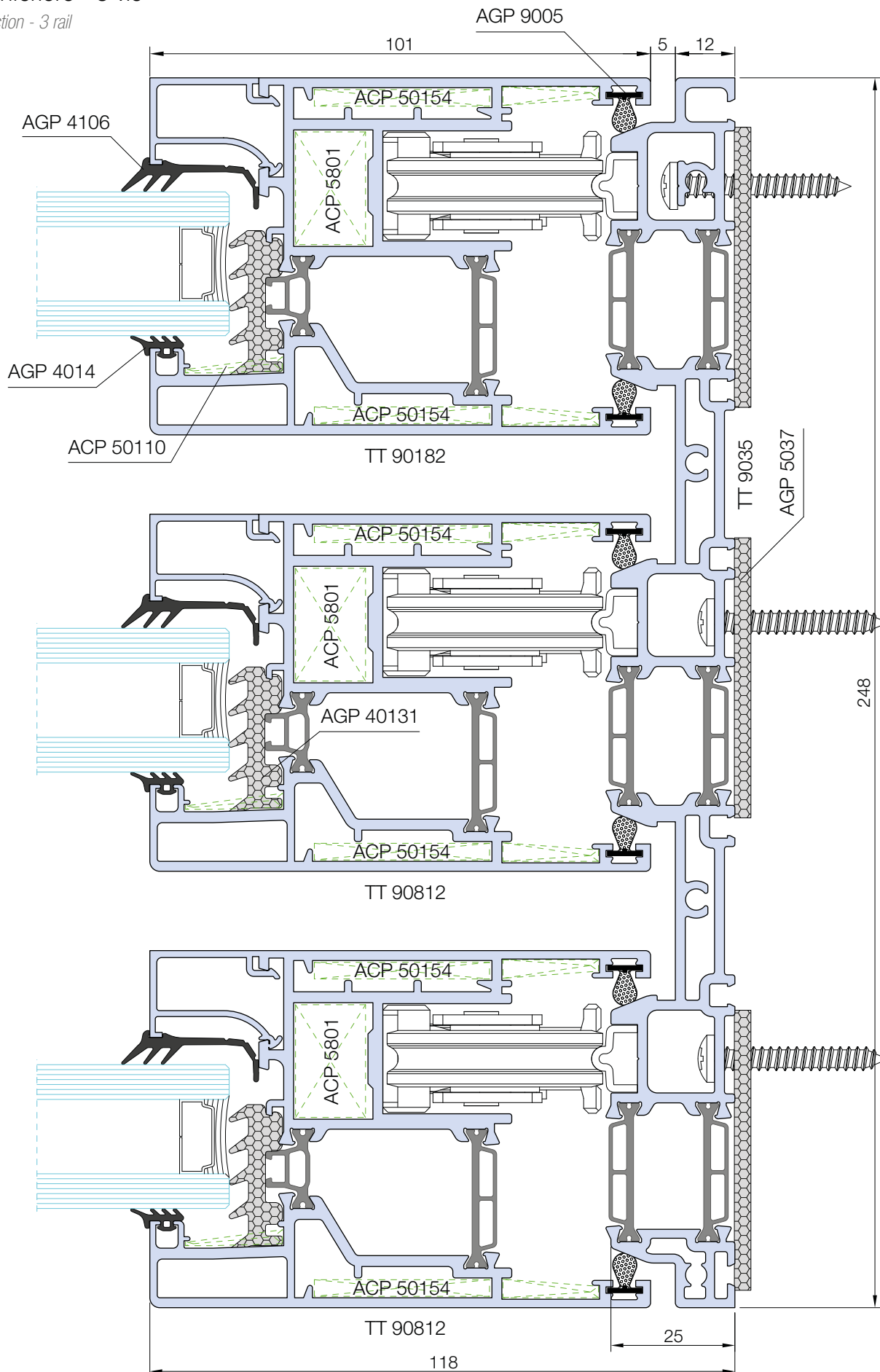

Nodo 24

Nodo laterale esterno - 3 vie

External lateral section - 3 rail

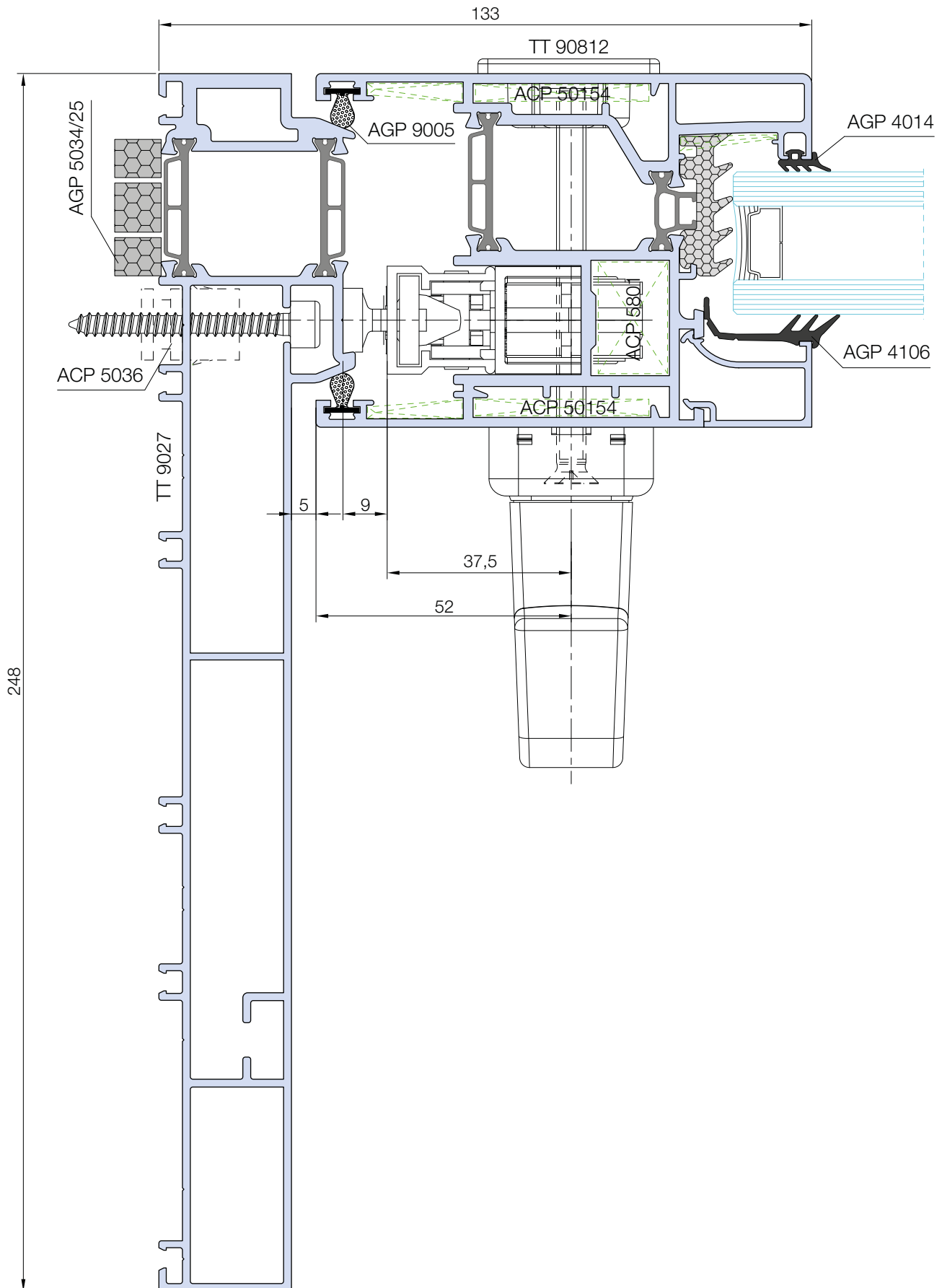

Nodo 25

Nodo laterale interno - 3 vie

Inner lateral section - 3 rail

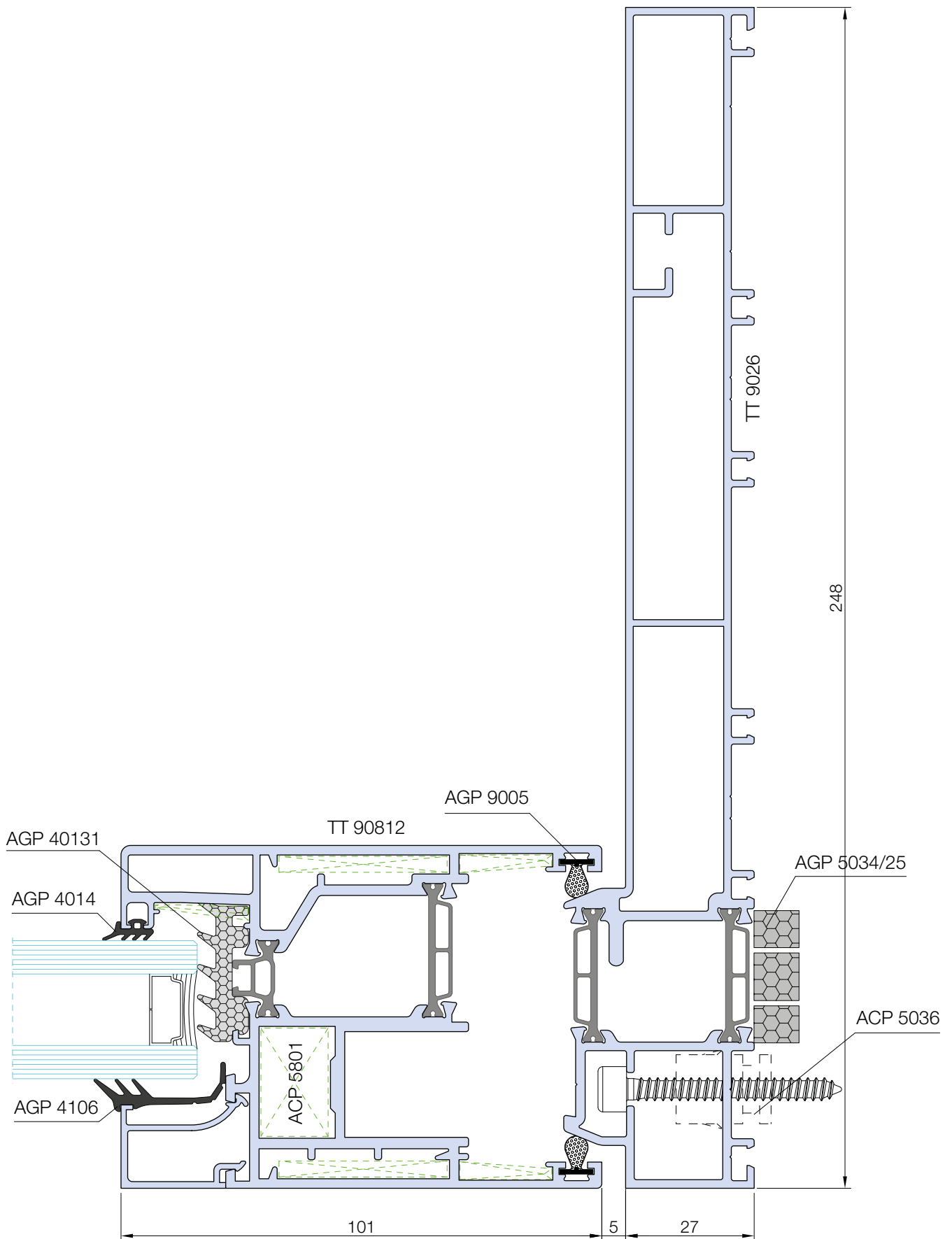

NODI E SEZIONI

Sections

Nodo 26

Nodo inferiore - monovia con soglia ribassata

Lower section - 1 rail+low threshold

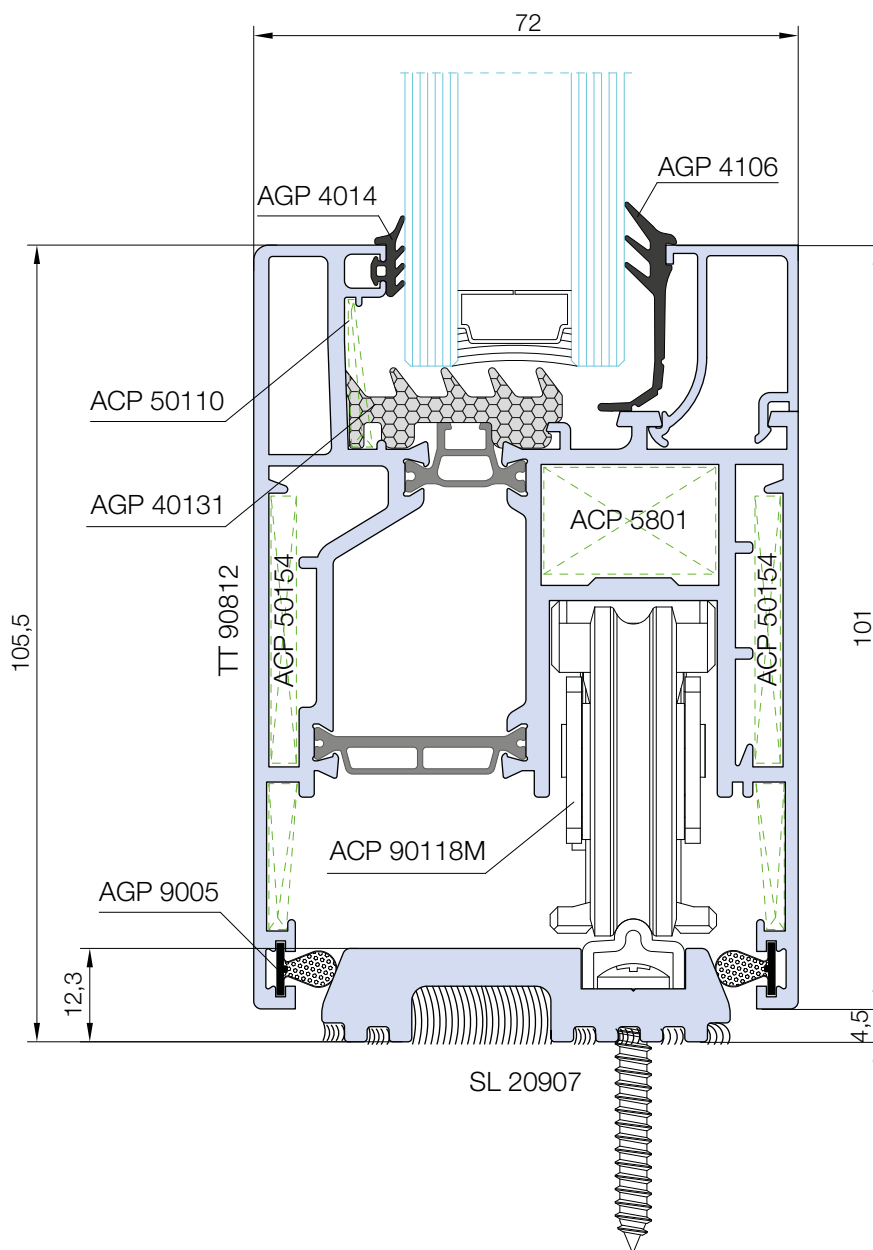

Nodo 27

Nodo inferiore con soglia ribassata

Lower section+low threshold

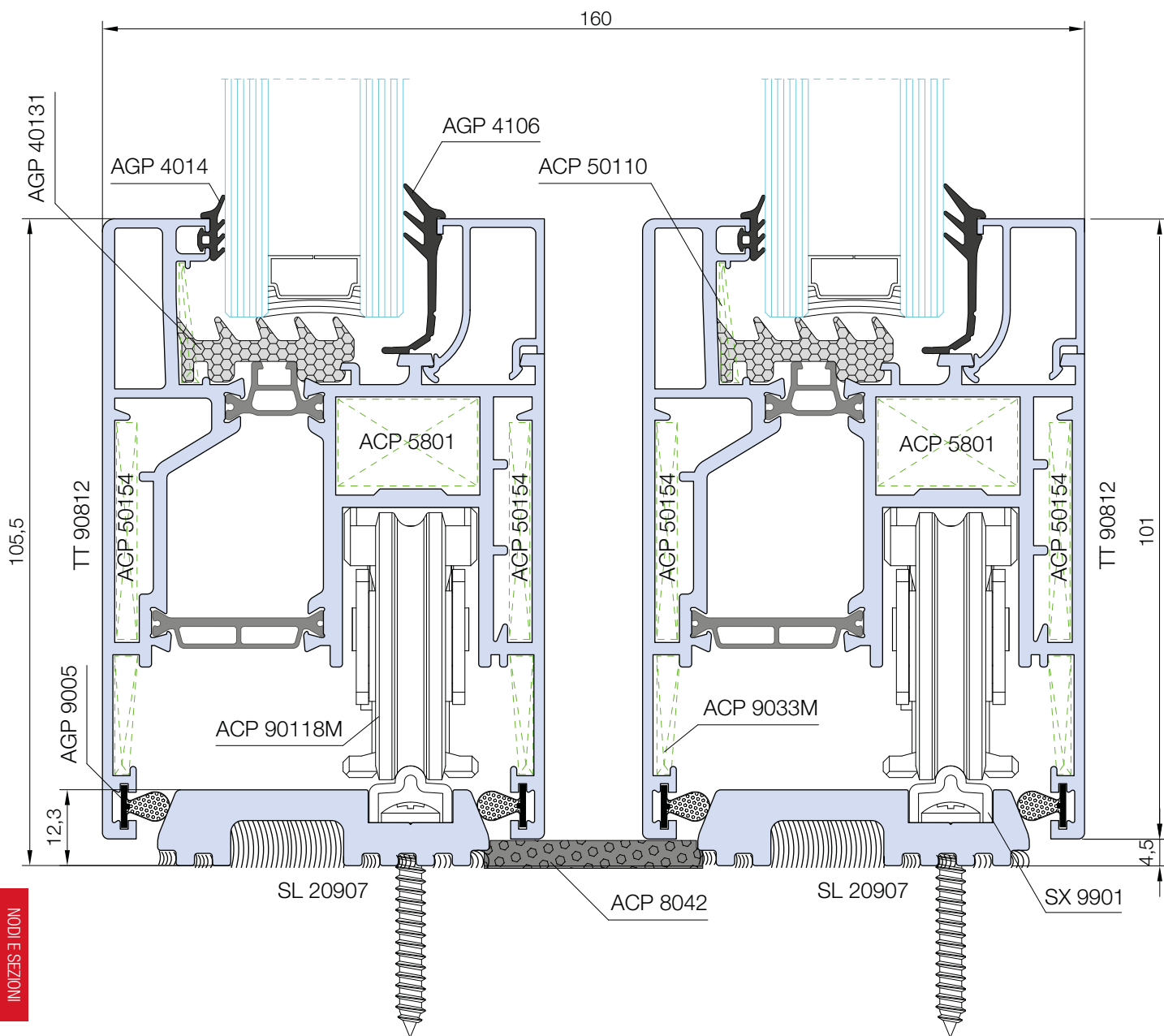

Nodo 28

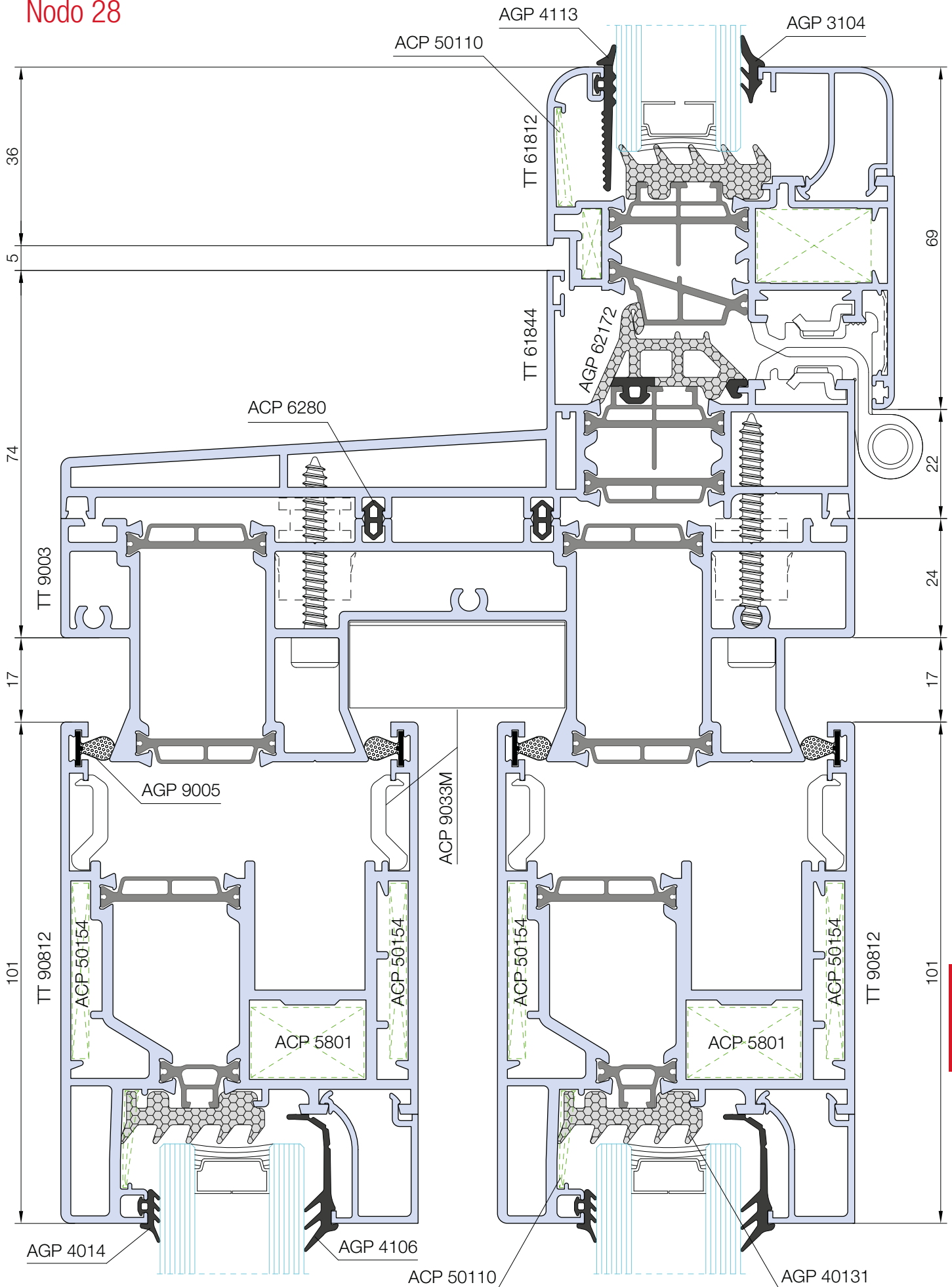

Nodo 29

Nodo inferiore - due vie con soglia filo pavimento

Lower section - 2 rail+ floor threshold

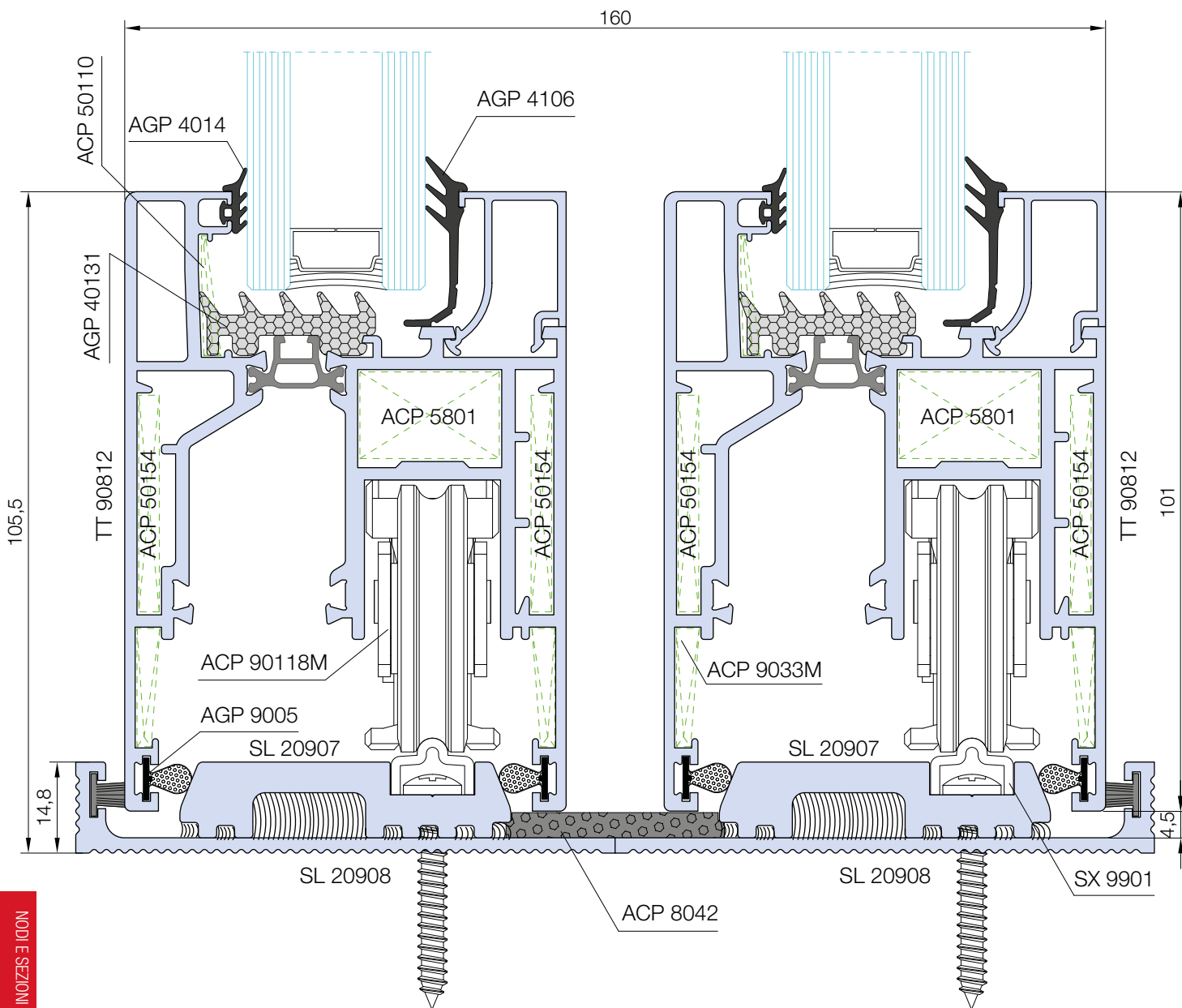

NODI E SEZIONI
Sections

Nodo 30

Nodo laterale interno fisso

Lateral section fixed inner

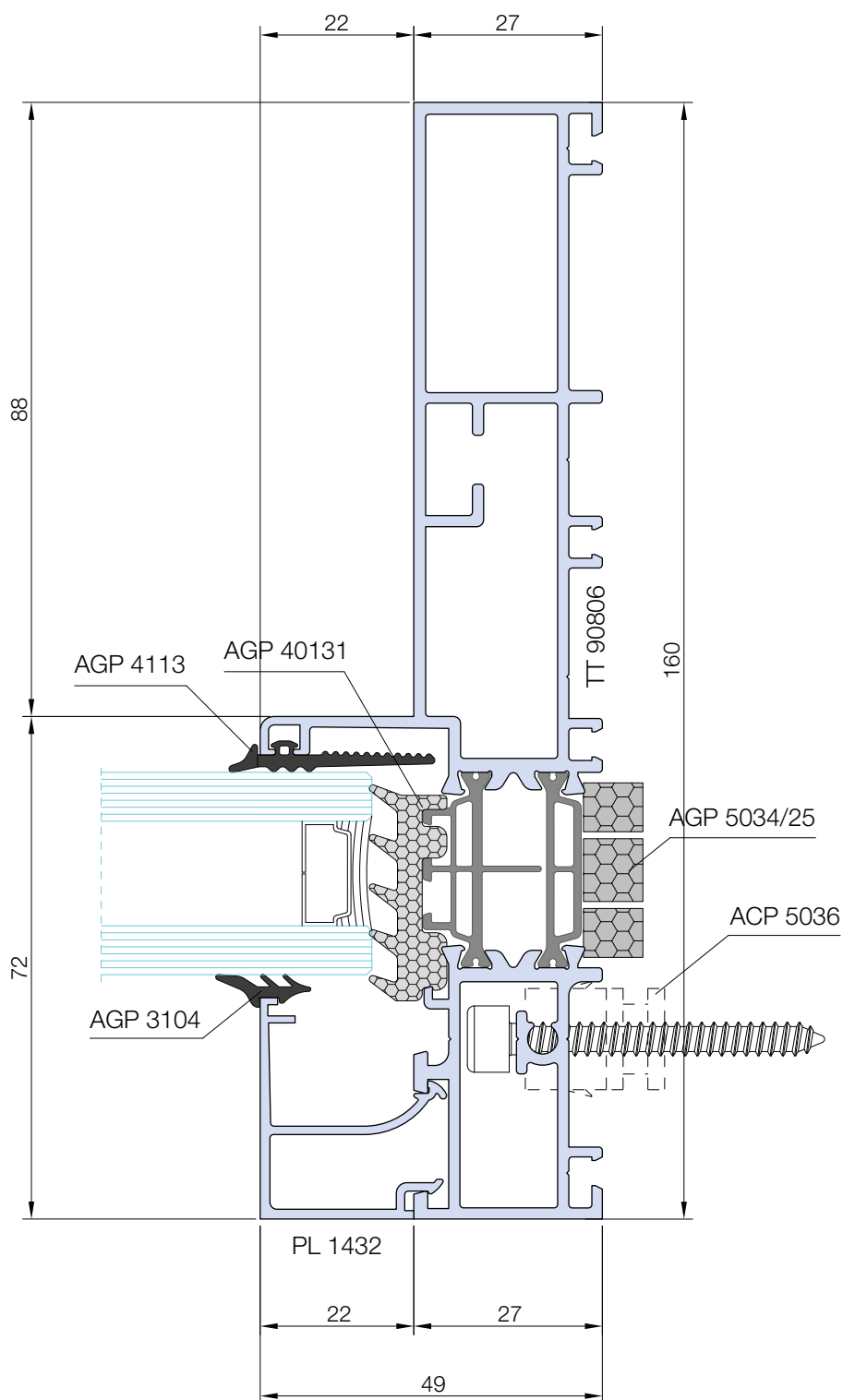

Nodo 31

Nodo superiore apribile interno/fisso interno

Upper section inner open/fixed inner

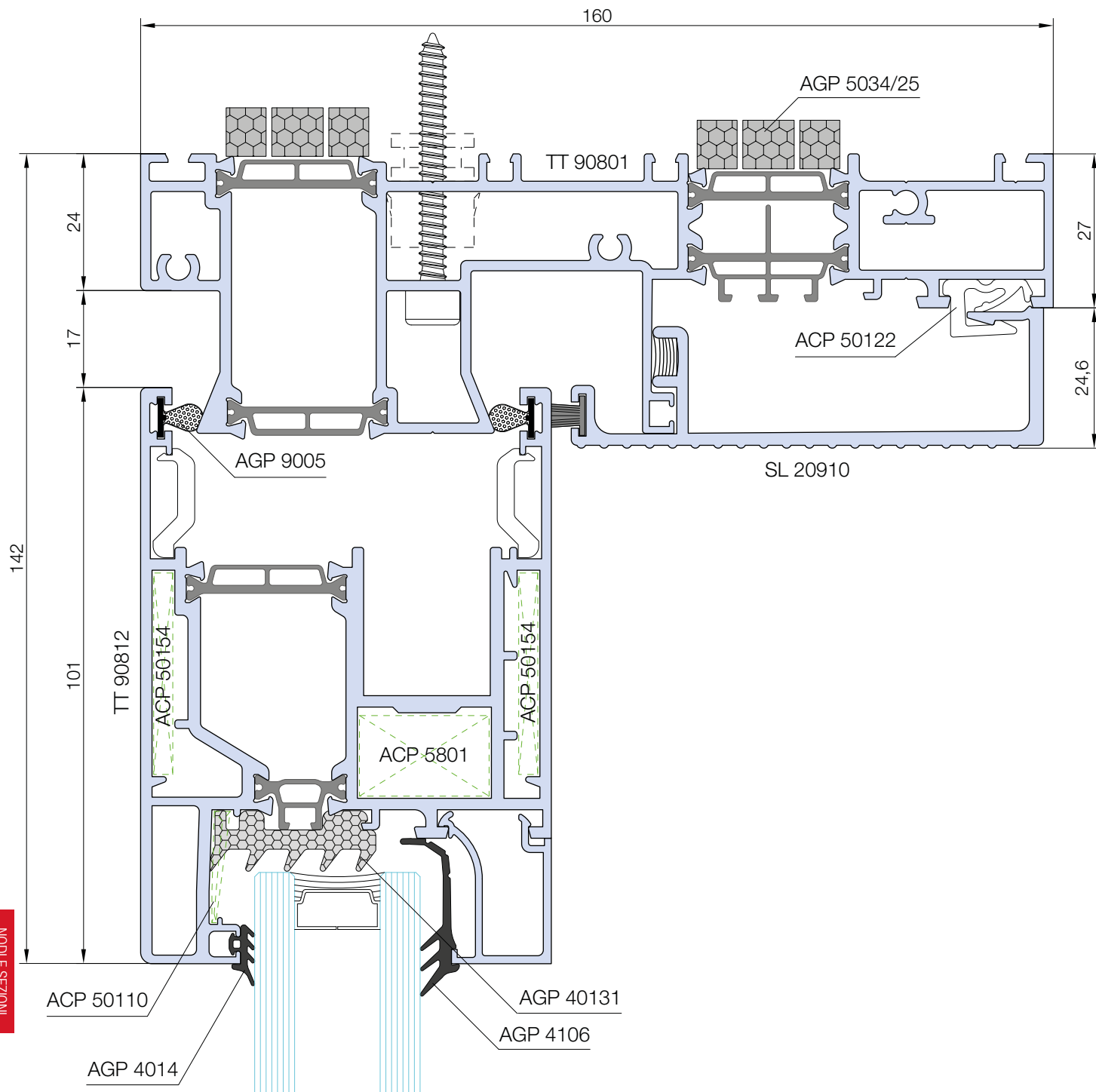

NODI E SEZIONI
Sections

Nodo 32

Nodo superiore e inferiore apribile esterno/fisso interno

Upper and lower section external open/fixed inner

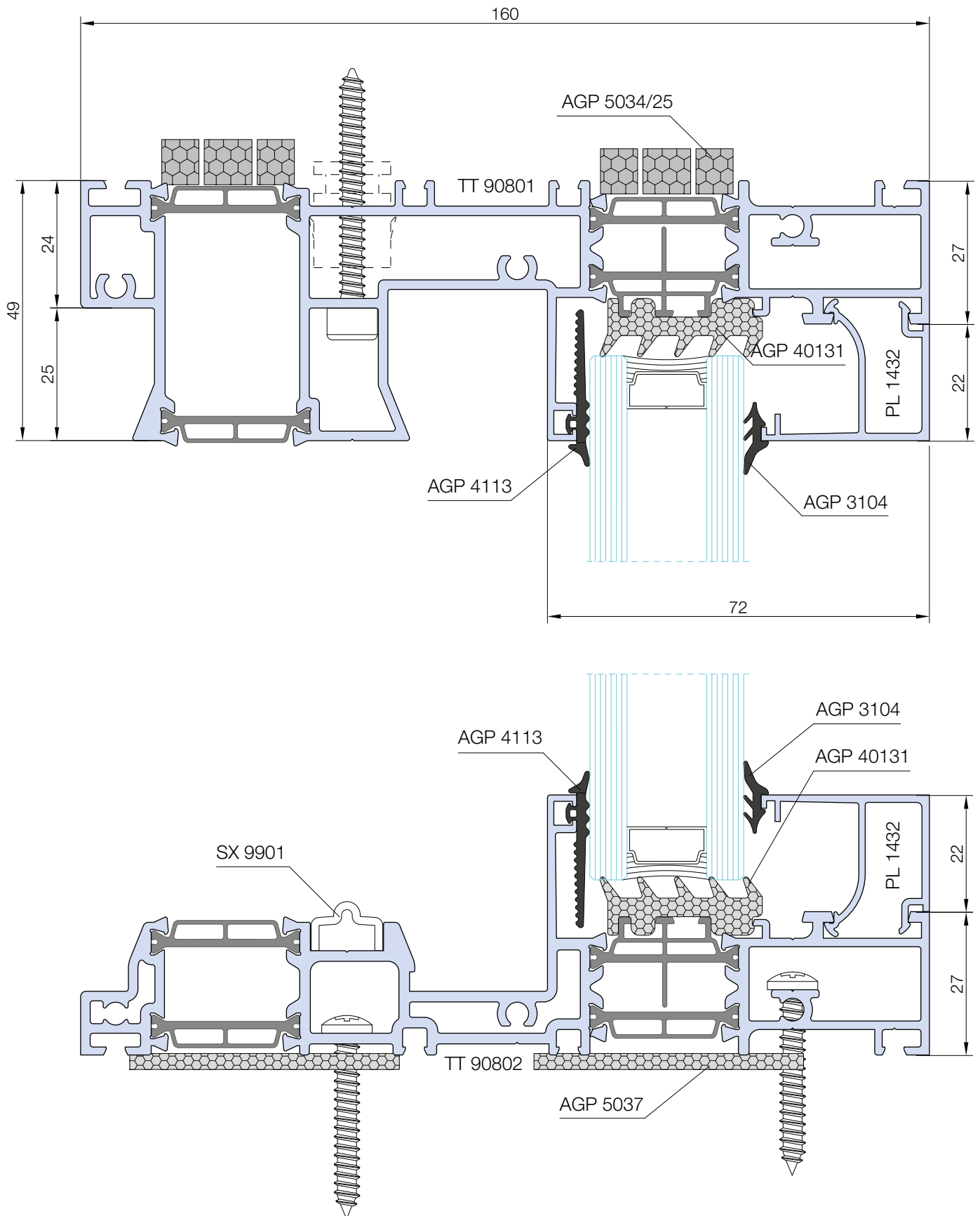

Nodo 33

Nodo inferiore apribile esterno/fisso interno

Lower section external open/fixed inner

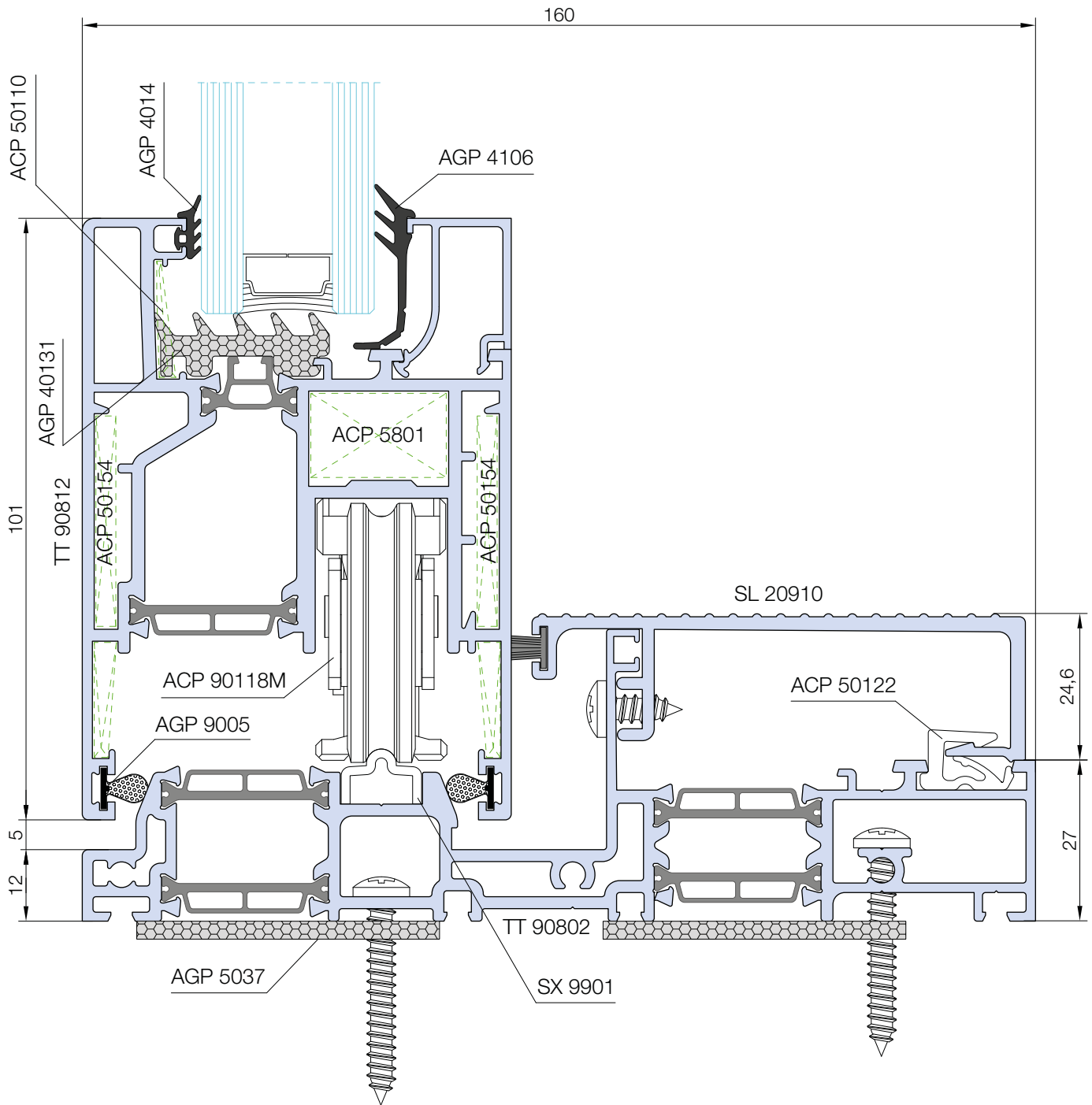

Nodo 34

Nodo centrale ridotto

Lowered central section

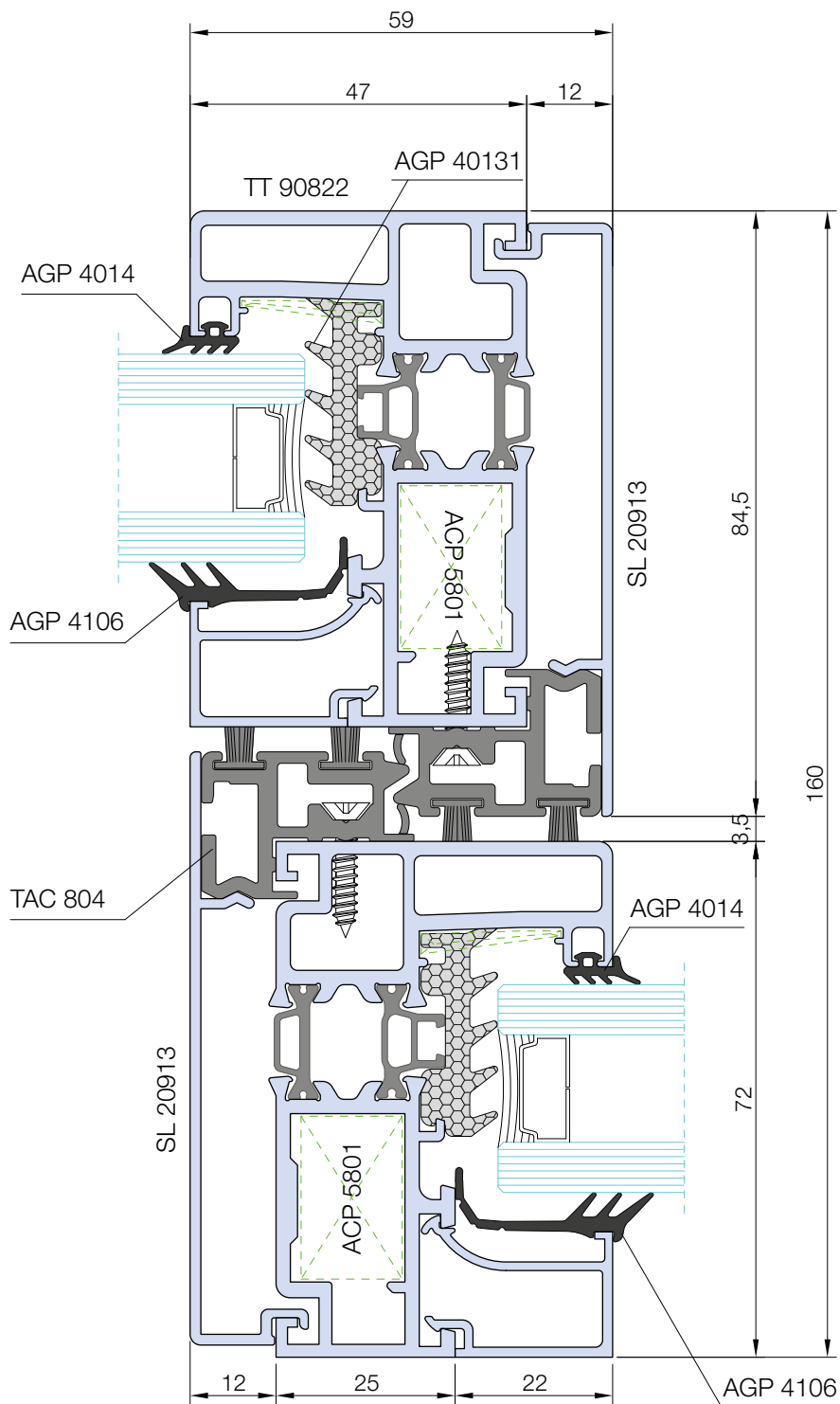

Nodo 35

Nodo chiusura angolo 90°

Closure section 90°

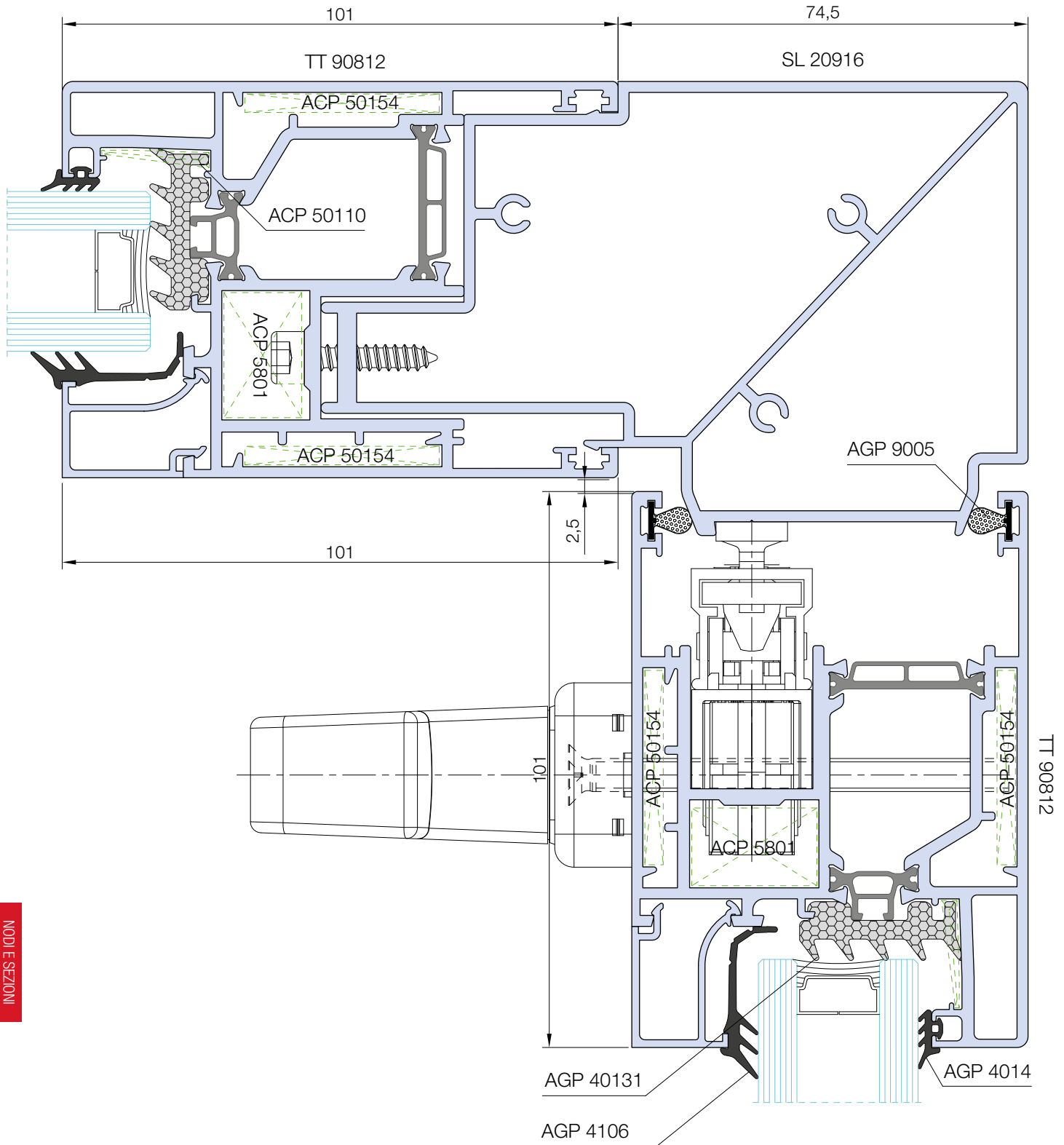

NODI E SEZIONI
Sections

ELENCO ATTEZZATURE



MCT PL 14485

Questa punzonatrice esegue lavorazioni per la serie Top Slide160

- Foro Ø 3mm per squadretta allineamento anta
- Foro Ø 8mm per spina squadretta assemblaggio anta
- Asola interna ed esterna areazione anta
- Lavorazioni passaggio binario

This punching machine is for Top Slide160

- Ø 3mm hole for alignment corner bracket
- Ø 8mm hole for pin assembly corner cleat sash
- Sash ventilation
- Working rail passage

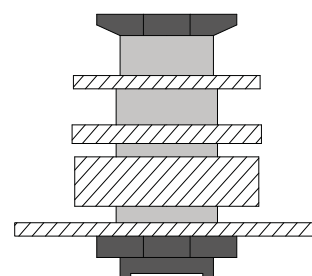

MCT PL 48PT

Gruppo frese Top Slide160 per anta TT90812

Cutting machine Top Slide160 for sash TT90812

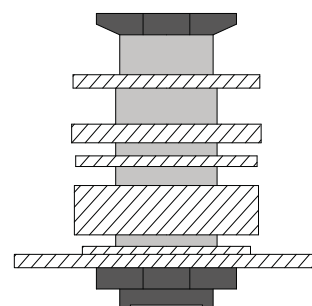

MCT PL 49PT

Gruppo frese Top Slide160 per anta TT90811

Cutting machine Top Slide160 for sash TT90811

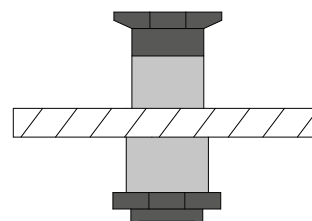

MCT PL 41PT

Gruppo frese Top Slide160 per lavorazioni intestazioni montanti

Cutting machine Top Slide160 for machining mullion connection

MCT PL 14485

Punzonatrice Top Slide 160 MCT PL 14485

Top Slide MCT PL 14485 punching machine

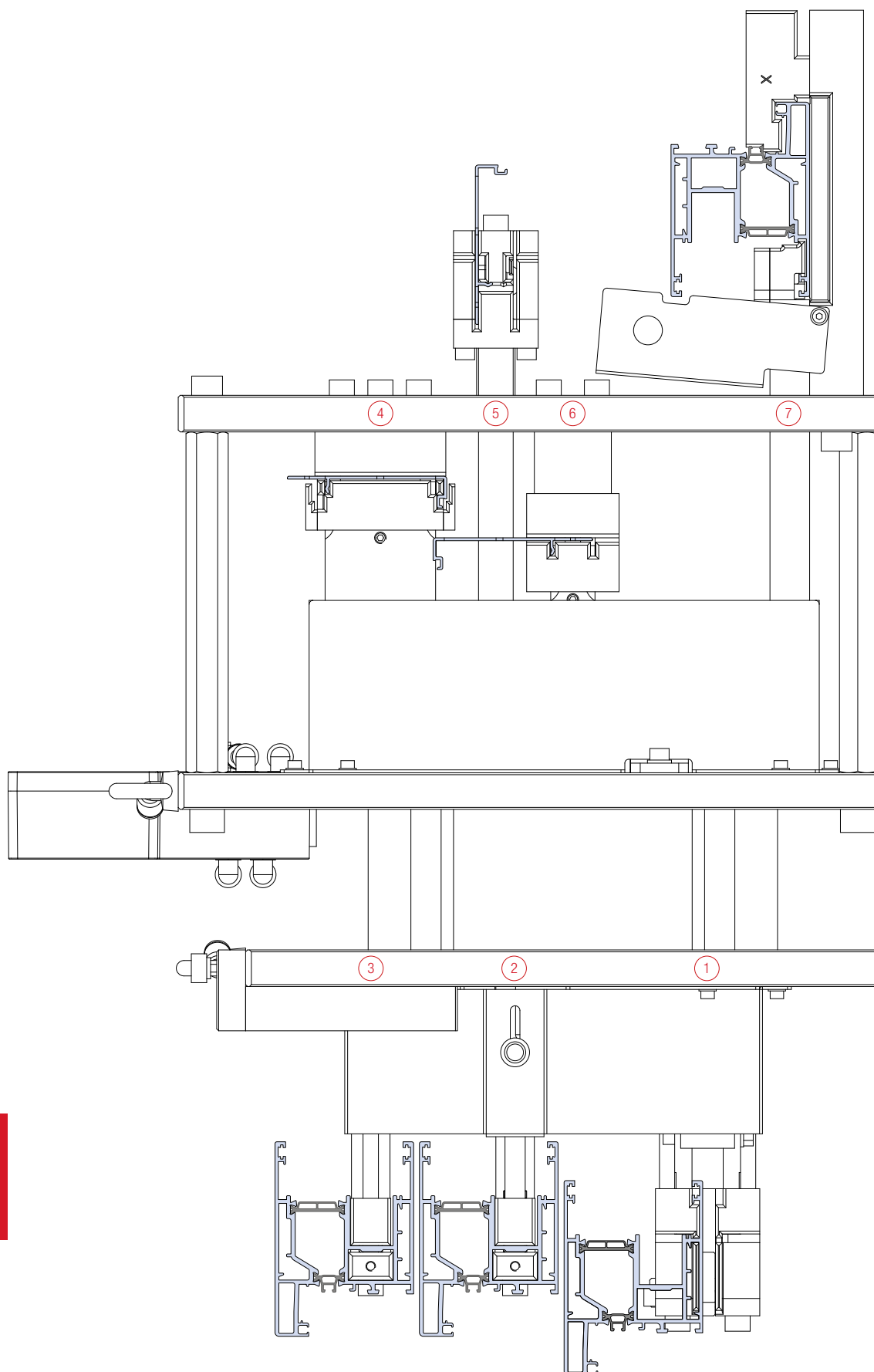

- ① Foro Ø3 per squadretta ACP 50154 / Ø3mm hole for ACP 50154
- ② Asola e foro per squadretta ACP 5002 / Slot and hole for ACP 5002
- ③ Foro Ø8mm per squadretta ACP 5801 / Ø8mm hole for ACP 5801
- ④ Asola e foro per tappo / Slot and hole for plug
- ⑤ Rasatura alette clip e spuntatura dentini su copertina / Rasatura alette clip e spuntatura dentini su copertina
- ⑥ Spacco e foro Ø2.5 su copertina / Spacco e foro Ø2.5 su copertina
- ⑦ Asola interna esterna per areazione anta / Internal external slot for sash ventilation

L1 

Foro Ø3mm per spina ACP 5030 squadretta ACP 50154

Ø3mm hole for pin ACP 5030, ACP 50154

TT 90812

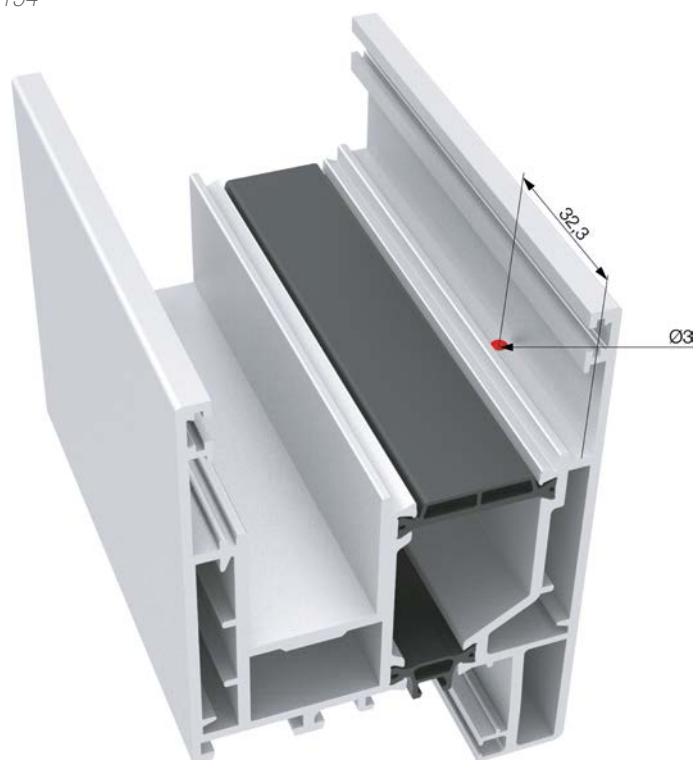

L2 

Foro Ø3mm per spina ACP 5030 squadretta ACP 50154

Ø3mm hole for pin ACP 5030, ACP 50154

TT 90812

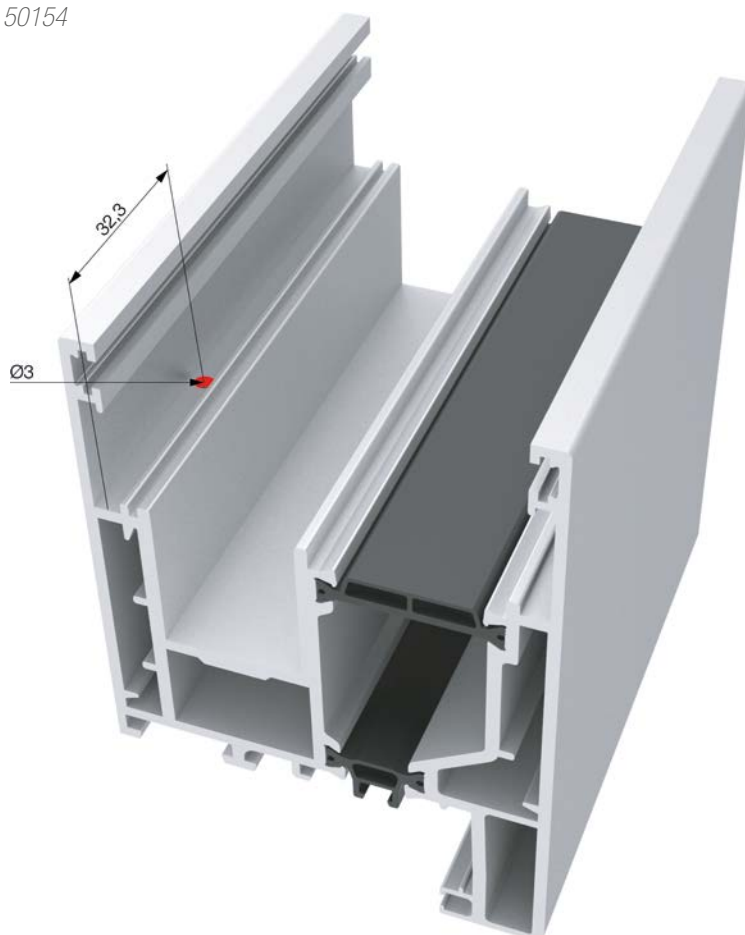

L3 

Asola interna per areazione anta

Internal slot for sash ventilation

TT 90812

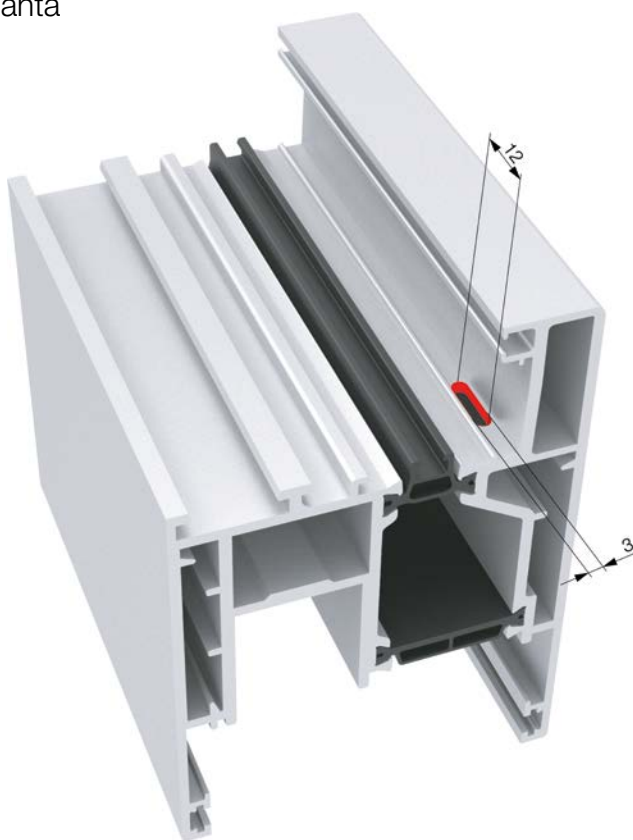

L4 

Asola esterna per areazione anta

External slot for sash ventilation

TT 90812

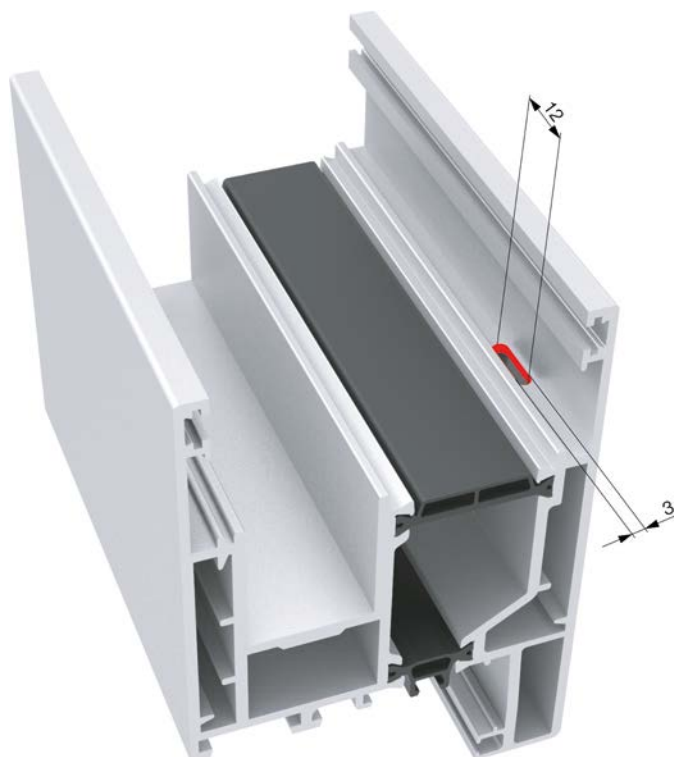

L5 

Foro Ø8mm per spina o vite squadretta multifunzione
Ø8mm hole for pin or screw multi-purpose bracket

TT 90812

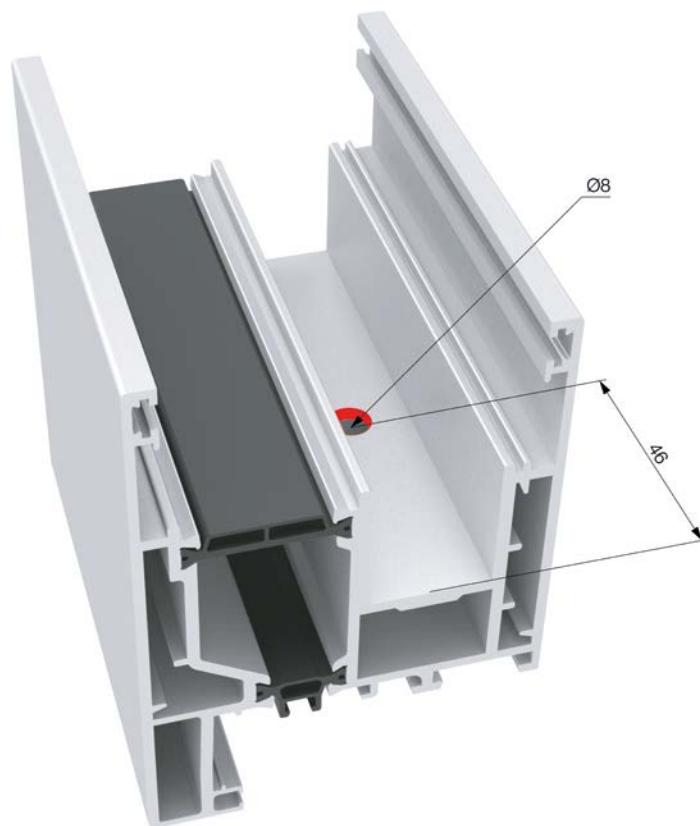

L6 

Prima lavorazione passaggio binario

First machining for rail passage

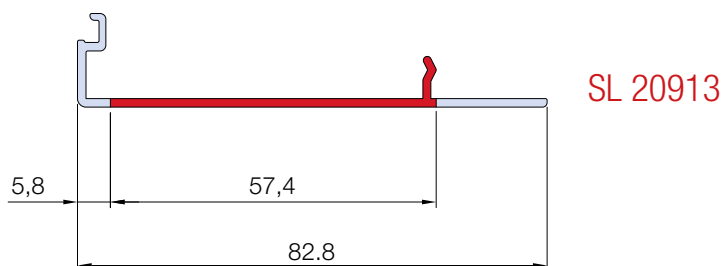
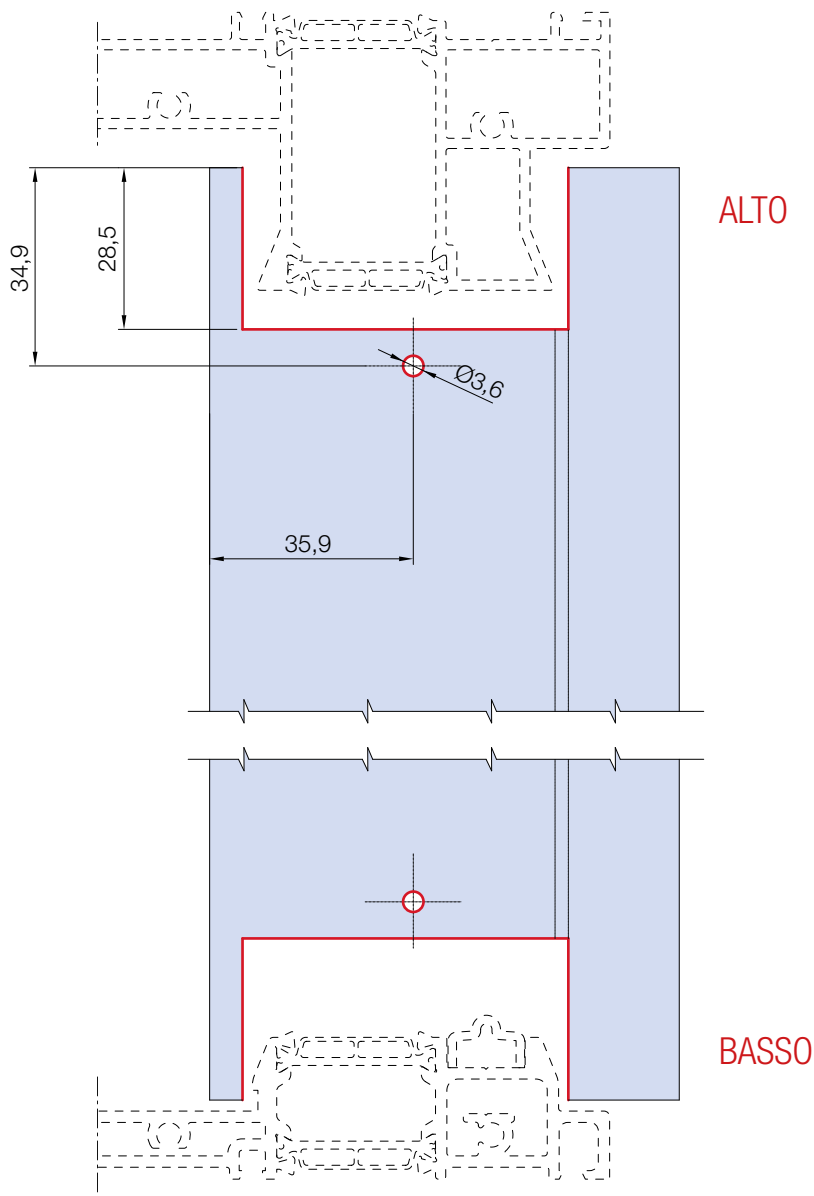
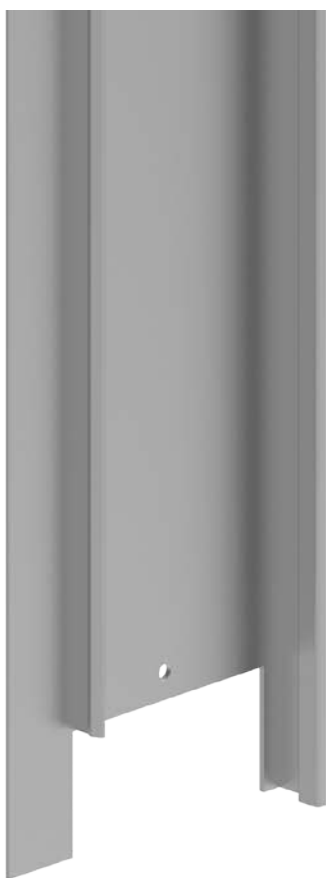

L7

Seconda lavorazione passaggio binario

Second machining for rail passage

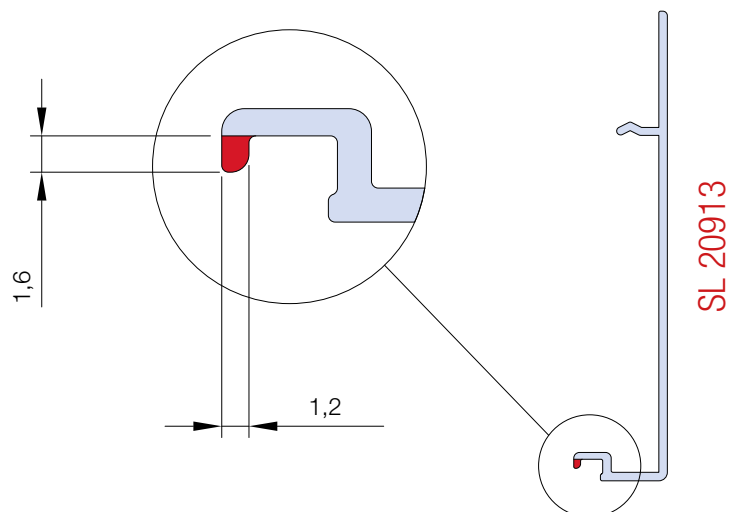
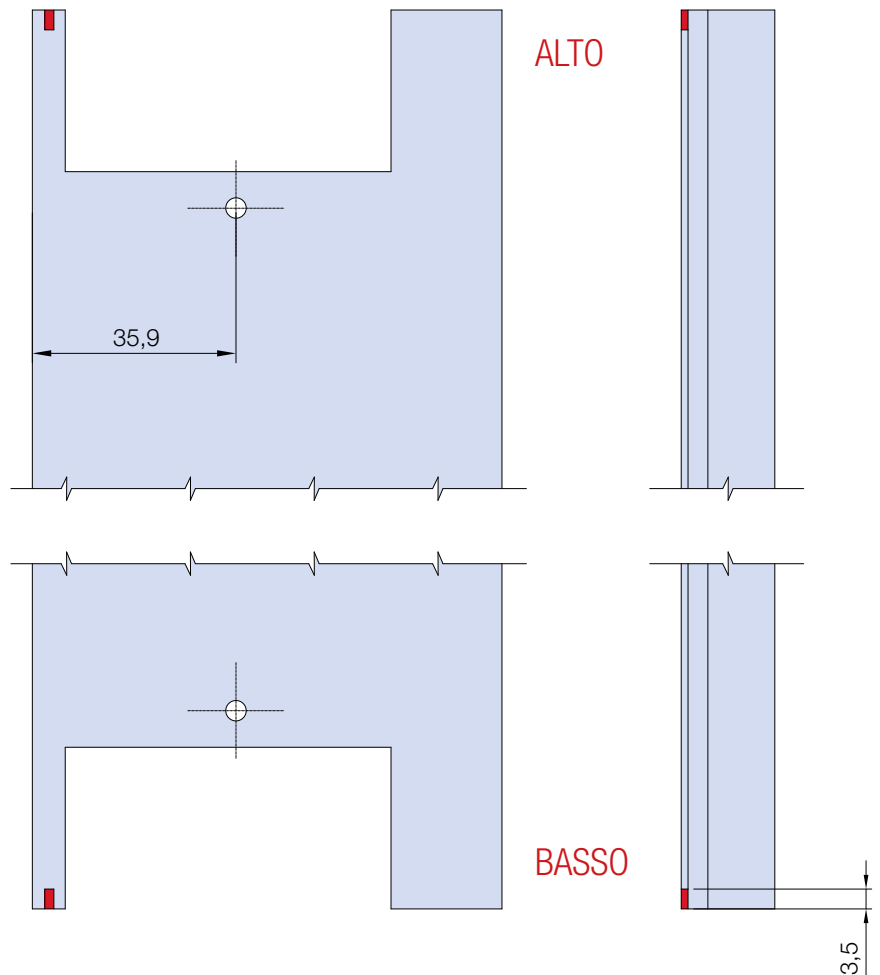

L8

Lavorazioni intestazioni montanti
Machining mullion connection

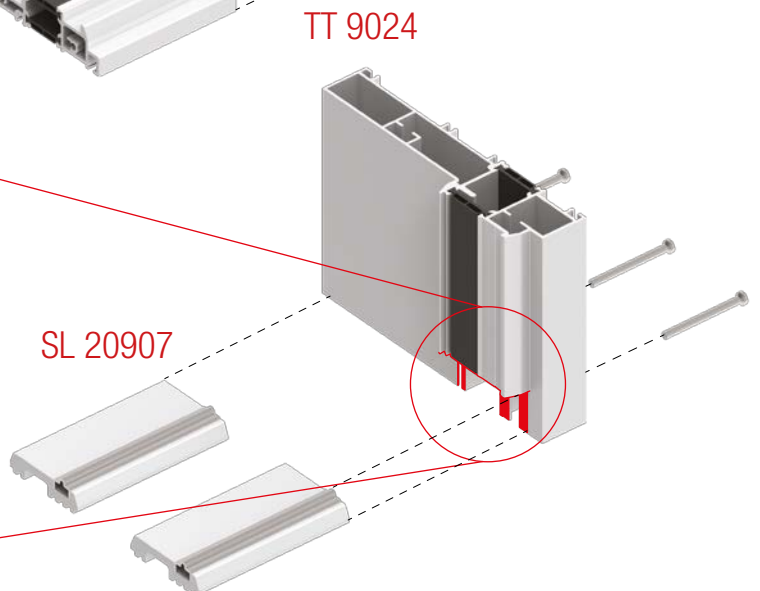
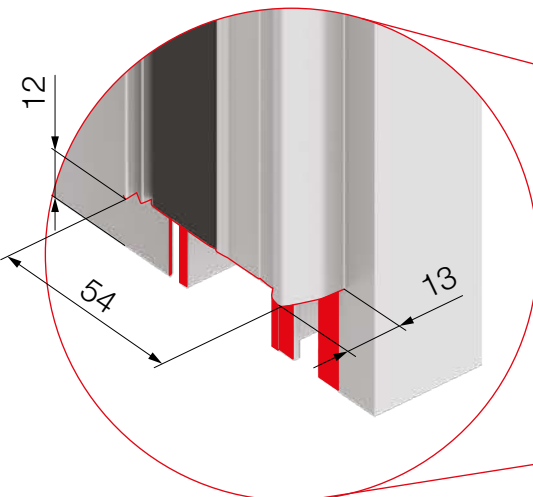
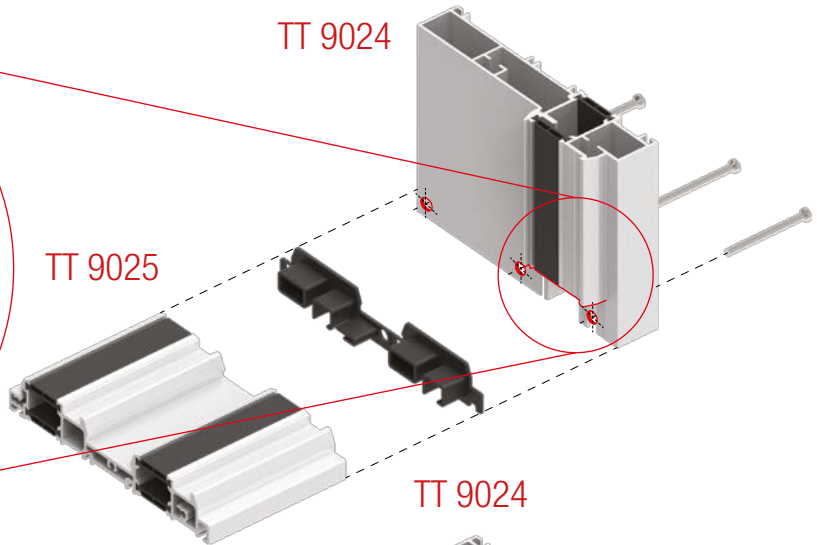
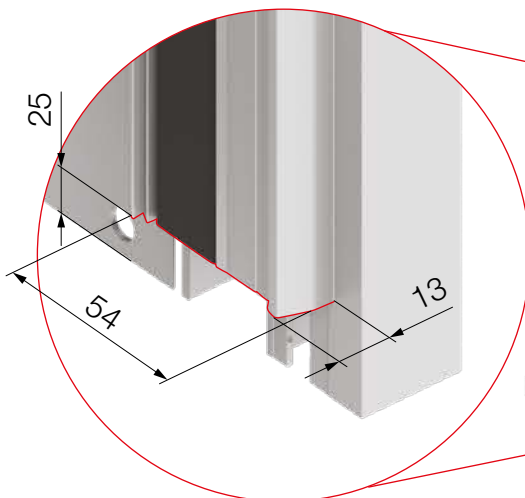
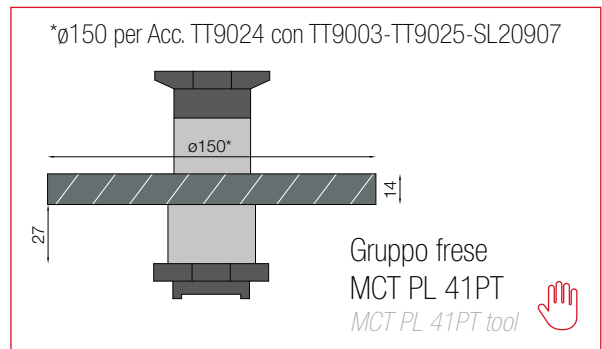
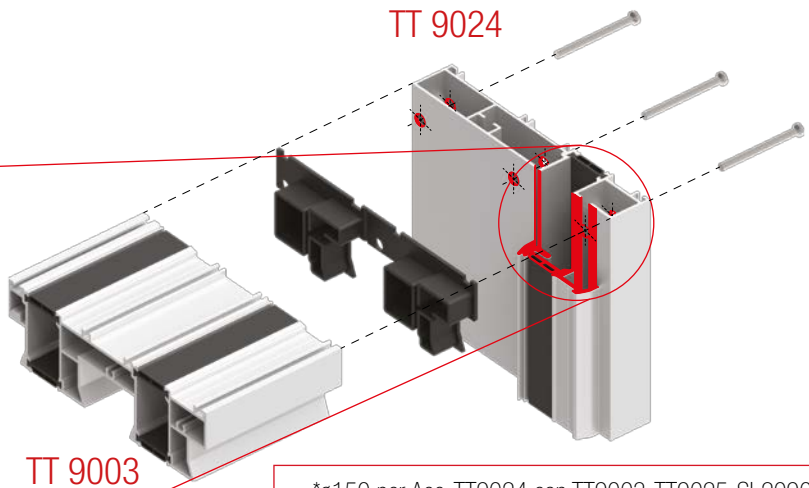
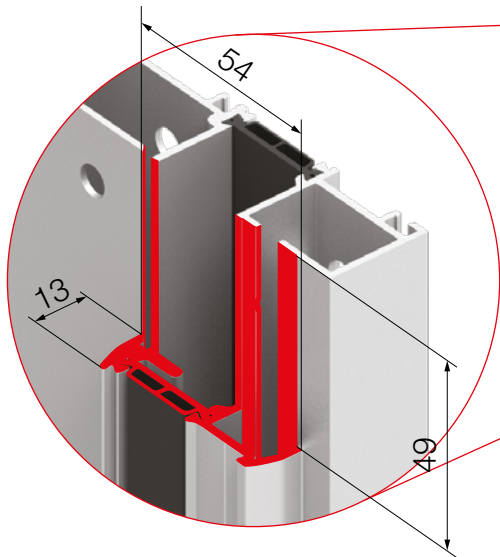



Lavorazione e montaggio soglia ribassata SL 20907

Low treshold application on SL 20907

- 1** Realizzare gli scarichi acqua sulla soglia SL 20907
To make the drainage on SL 20907

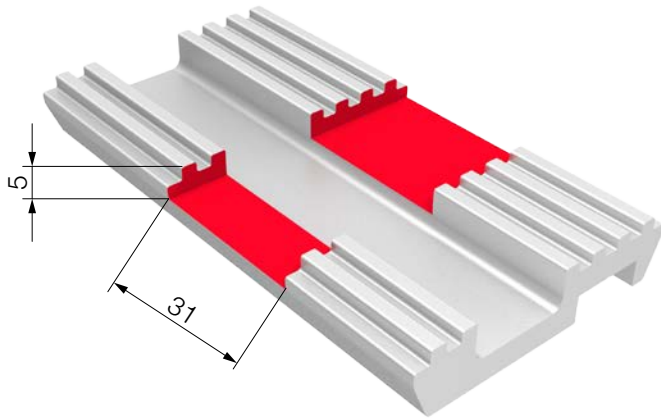

- 5** Sigillare la soglia SL 20907 e posizionare la guida in acciaio inox SX 9901
Seal SL 20907 and fix the stainless steel guide SX9901

Seal SL 20907 and fix the stainless steel guide SX9901

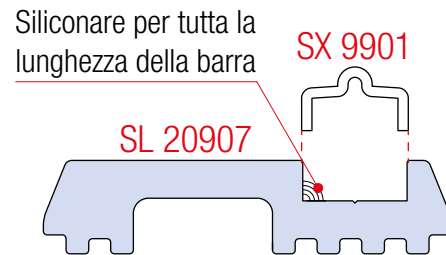

- 4** Fissare la soglia a pavimento con l'ausilio di tasselli
Fix the threshold on the floor, using blocks

- 2** Posizionare il piatto di alluminio verniciato 40x2 tra le 2/3 soglie
Place the aluminum plate between 2/3 threshold

- 3** Sigillare lo spazio tra i dentini della soglia
Seal the space between threshold's pawls

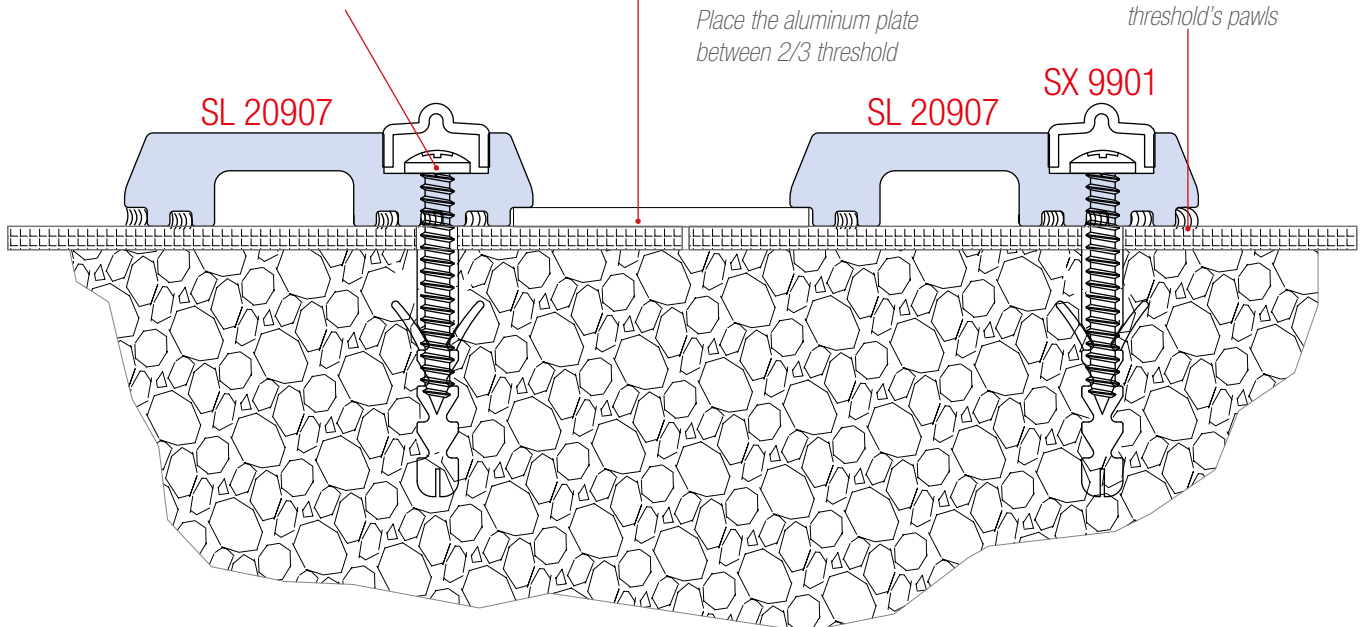

realizzare le lavorazioni ogni 300mm, come schema sotto

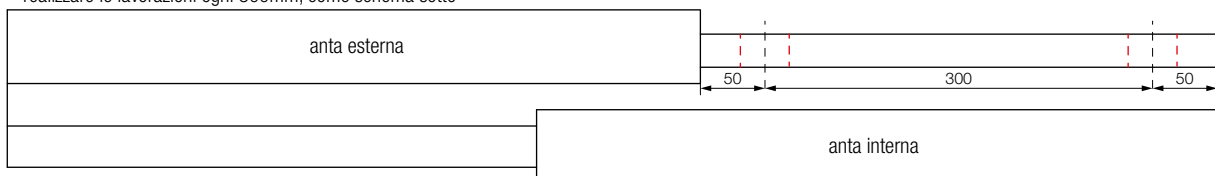

pianta della finestra con indicato dove realizzare le lavorazioni

L10

ACP 9028 lavorazione per cappette scarico acqua *ACP 9028 machining for water drain cup*

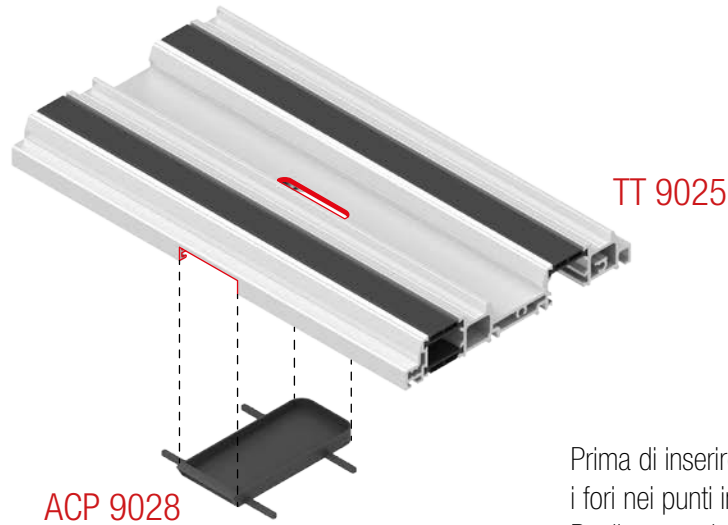

Prima di inserire la cappetta, chiudere i fori nei punti indicati da ambo i lati. Realizzare poi un cordolo di silicone su tutto il perimetro e solo dopo inserire la cappetta

Before put the cup, close the indicated holes. Seal with silicone along the perimeter and only after insert the cup

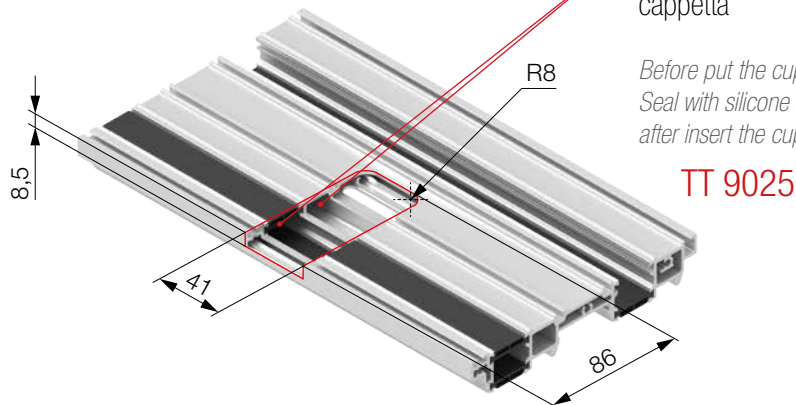

Fare l'asola in corrispondenza di ogni cappetta

Make the slot at each cup

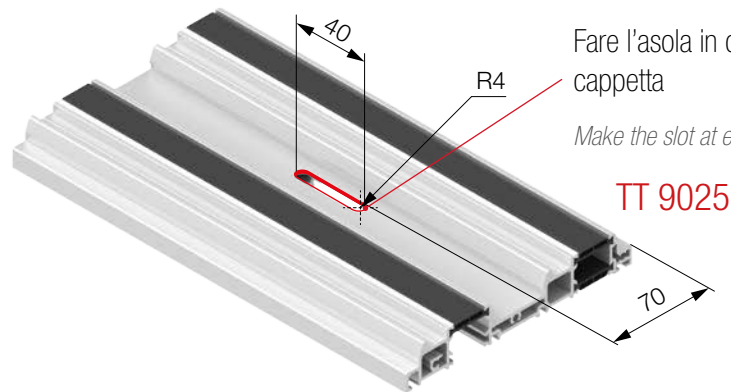

Fori scarico condensa (prevedere guaina butilica sottostante per convogliare la condensa fuori)

Water drain holes (provide for butyl sheath below to direct water drain out)

realizzare le lavorazioni ogni 300mm, come schema sotto

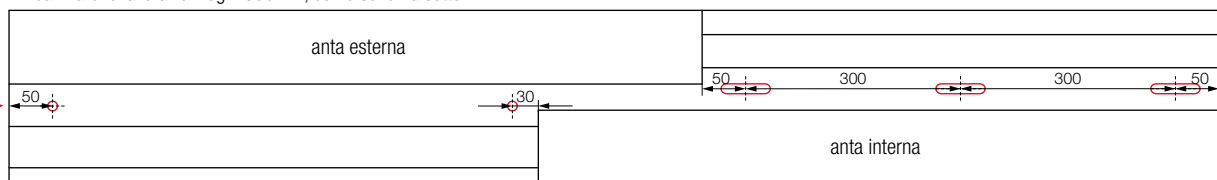

pianta della finestra con indicato dove realizzare le lavorazioni

LAVORAZIONI E MONTAGGI
Machining and assembly

L11

ACP 9034 lavorazione per cappette scarico acqua

ACP 9034 machining for water drain cup

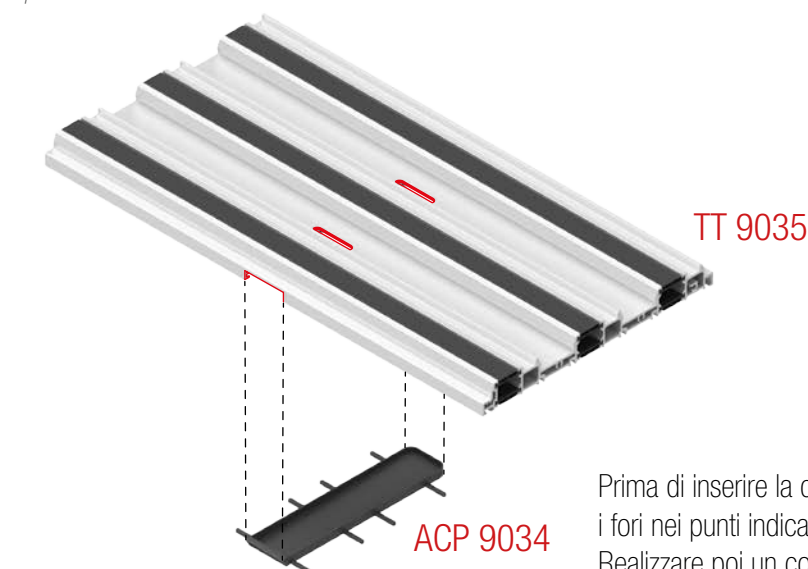

Prima di inserire la cappetta, chiudere i fori nei punti indicati da ambo i lati. Realizzare poi un cordolo di silicone su tutto il perimetro e solo dopo inserire la cappetta

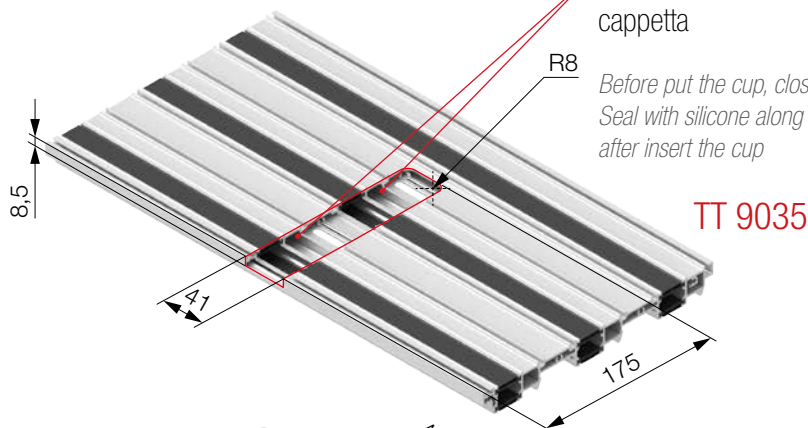

Before put the cup, close the indicated holes. Seal with silicone along the perimeter and only after insert the cup

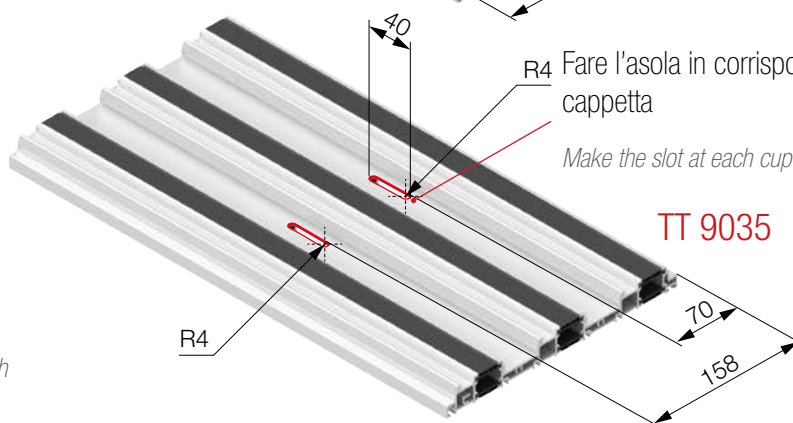

Fare l'asola in corrispondenza di ogni cappetta
Make the slot at each cup

Fori scarico condensa (prevedere guaina butilica sottostante per convogliare la condensa fuori)

Water drain holes (provide for butyl sheath below to direct water drain out)

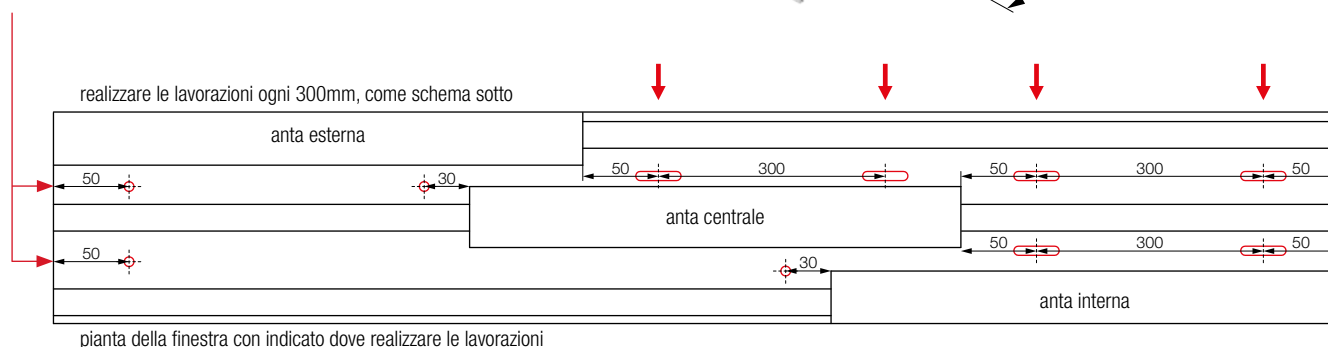

L12 

MCT PL 48PT

Gruppo frese per profili su anta TT90812

Cutting machine for sash TT90812

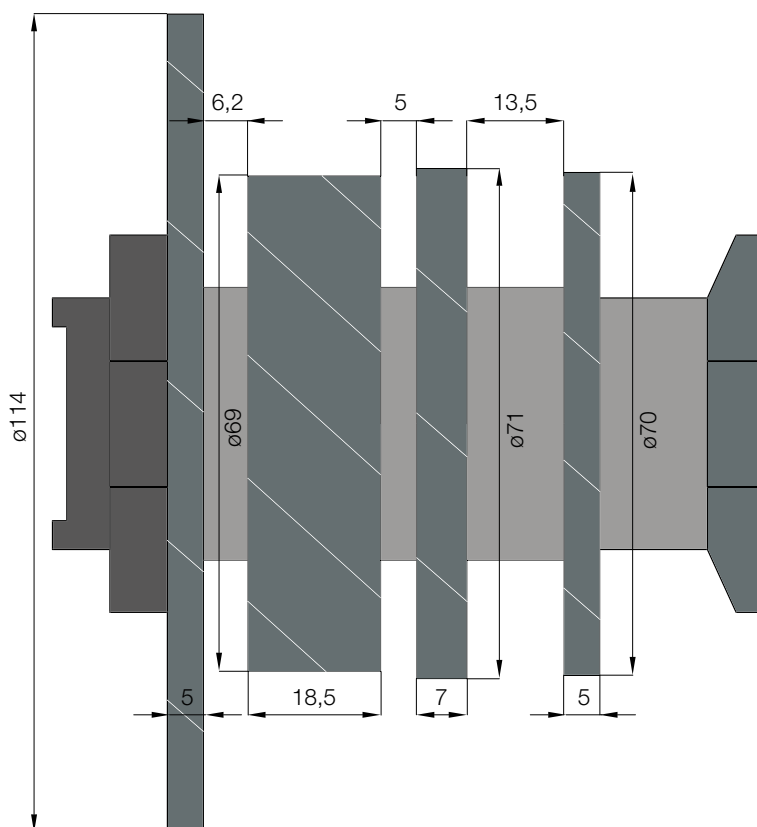
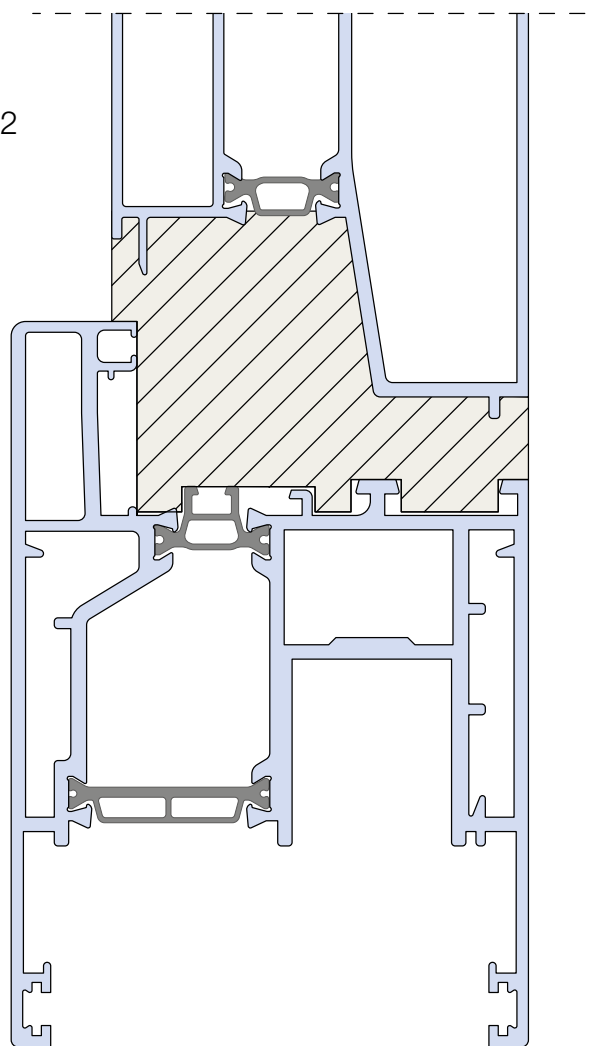

L13 

MCT PL 49PT

Gruppo frese per profili su anta TT90811

Cutting machine for sash TT90811

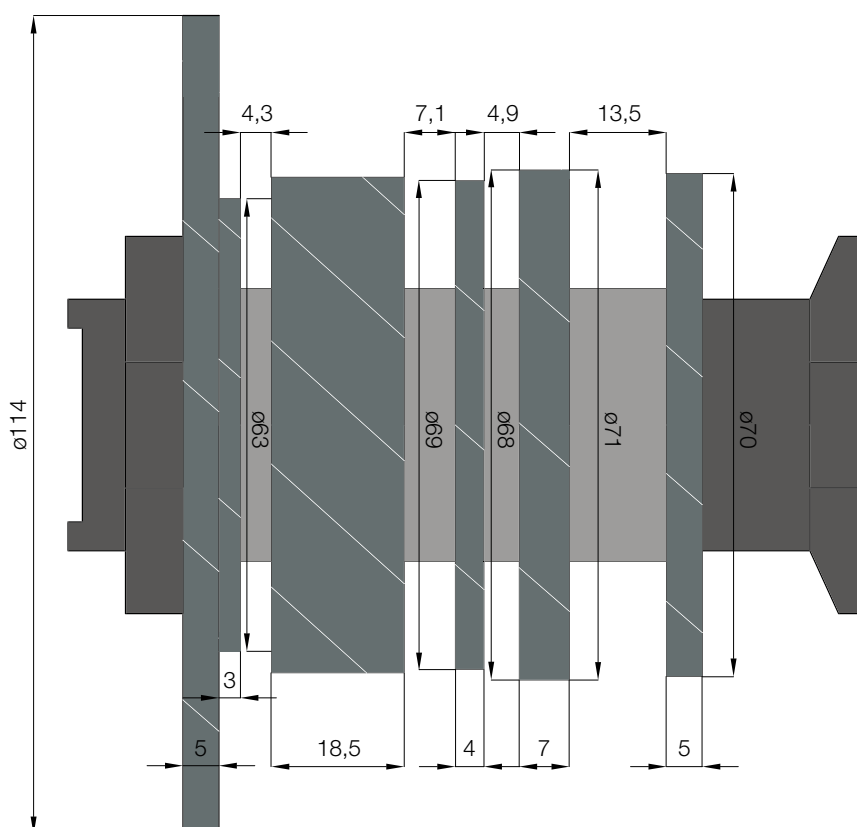
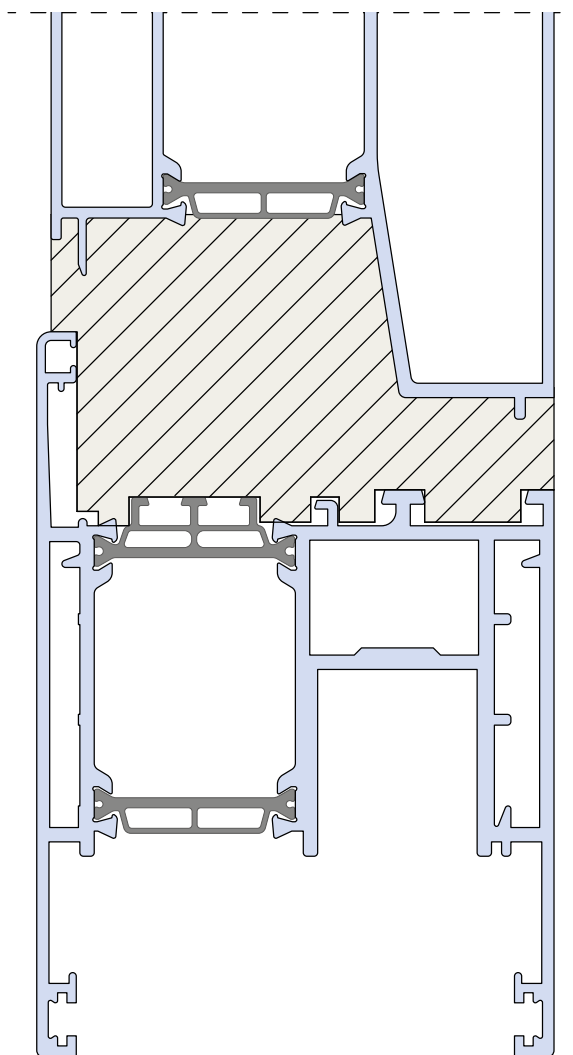

M1

Componenti kit ACP 9033M

ACP 9033M element kit

AC 040 x 1

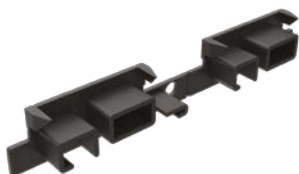

AC 041 x 1



AC 051 x 4



AC 042 x 1



AC 043 x 1



AC 054 x 4



AC 052 R x 2

AC 052 L x 2

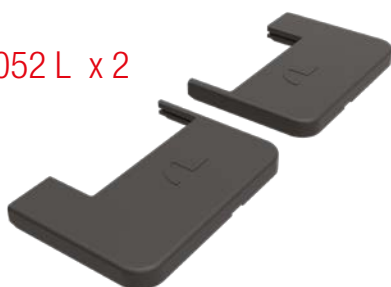

AC 053 x 16



vite in inox autofilettante TPS croce 4x13 x 4 pz.

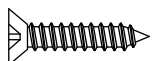

vite in inox autofilettante TPS croce 3x13 x 8 pz.

M2

ACP 9033M montaggio tappi accoppiamento montanti-traversi 2 vie

ACP 9033M transom-mullion matching plugs, 2-rail

Sui tappi superiori sono state create delle alette che debordano dalla sagoma del profilo per coprire l'alluminio grezzo, che si sarebbe visto per via dell'intestatura necessaria per l'assemblaggio fra traverso superiore e montante laterale, in corrispondenza del binario

Upper plugs are equipped with additional fins covering aluminum cuts

Nella parte del montante senza il binario verticale è possibile tagliare queste alette seguendo i tratti pretagliati posti nella parte posteriore del tappo

These fins can be removed by cutting along the signs on the back of the plug

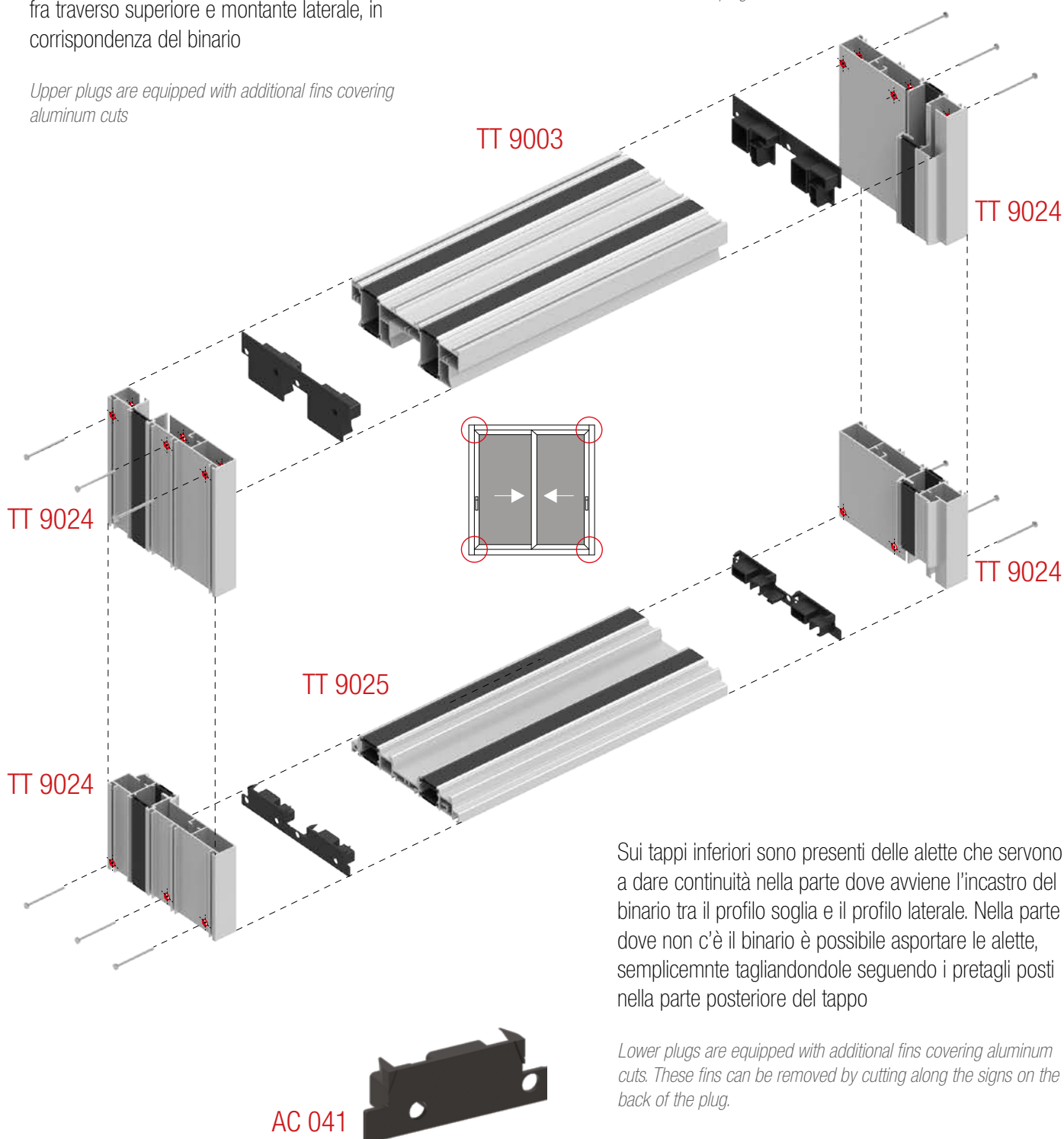

Sui tappi inferiori sono presenti delle alette che servono a dare continuità nella parte dove avviene l'incastro del binario tra il profilo soglia e il profilo laterale. Nella parte dove non c'è il binario è possibile asportare le alette, semplicemente tagliandole seguendo i pretagli posti nella parte posteriore del tappo

Lower plugs are equipped with additional fins covering aluminum cuts. These fins can be removed by cutting along the signs on the back of the plug.

M3

ACP 9033M montaggio tappi accoppiamento montanti-traverso monovia

ACP 9033M transom-mullion matching plugs, 1-rail

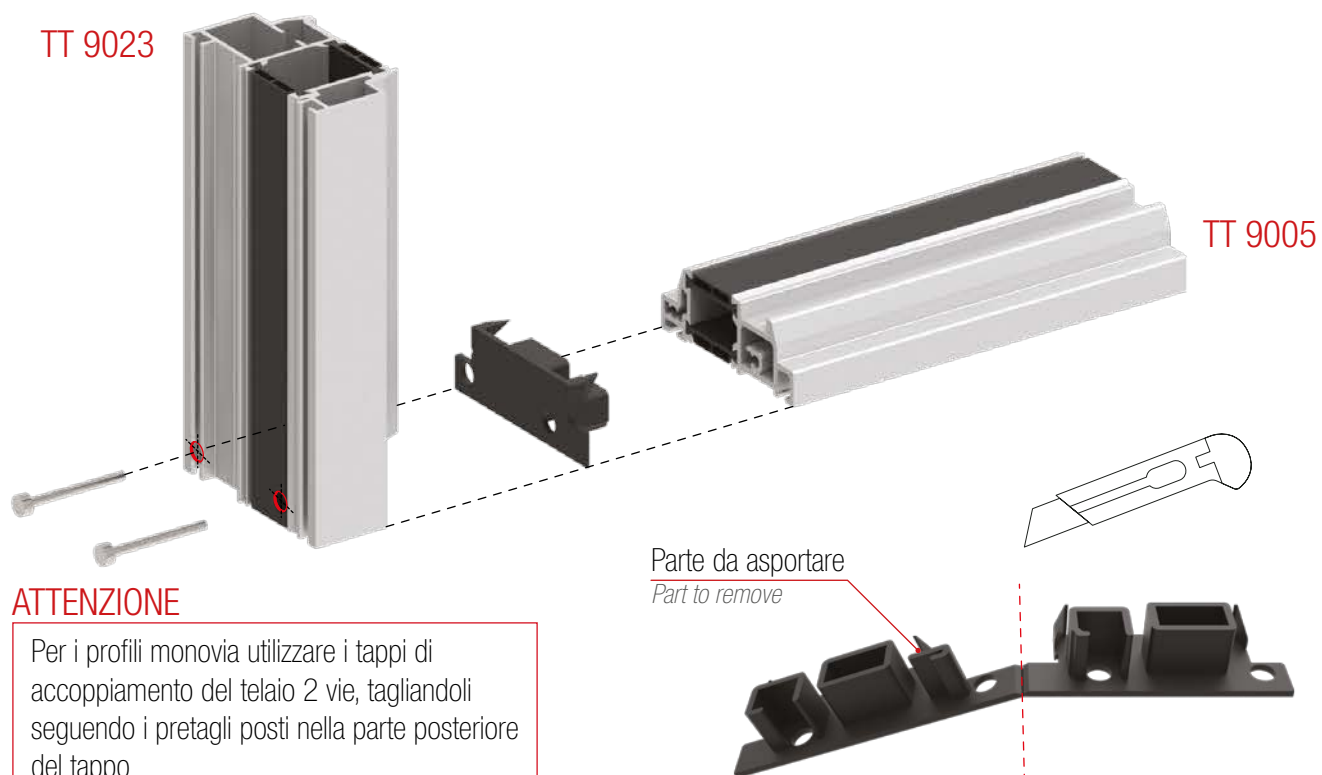
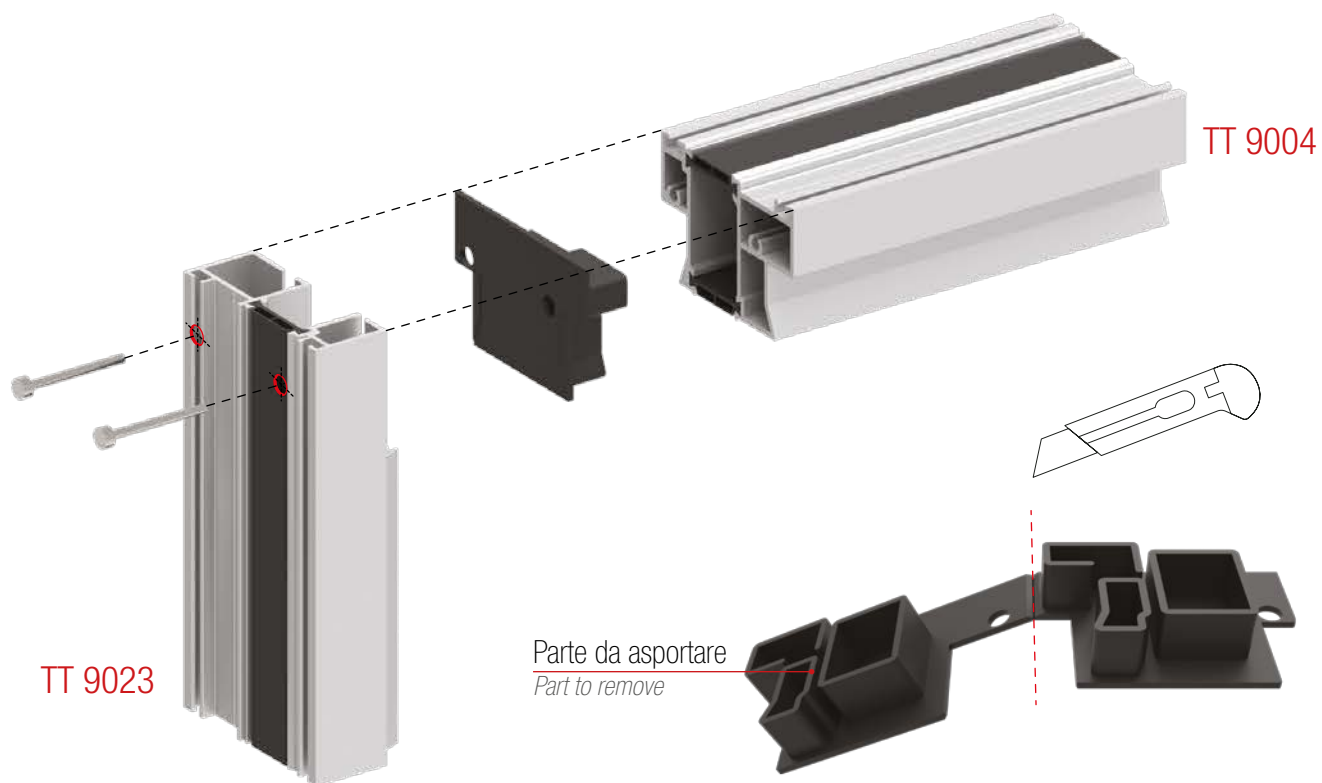

ATTENZIONE

Per i profili monovia utilizzare i tappi di accoppiamento del telaio 2 vie, tagliandoli seguendo i pretagli posti nella parte posteriore del tappo

*For 1-rail profiles, use 2-rail matching plugs.
Cut them, along the pre-cut line*

M4

ACP 9033M montaggio tappi accoppiamento montanti-traversi 3 vie

ACP 9033M transom-mullion matching plugs, 3-rail

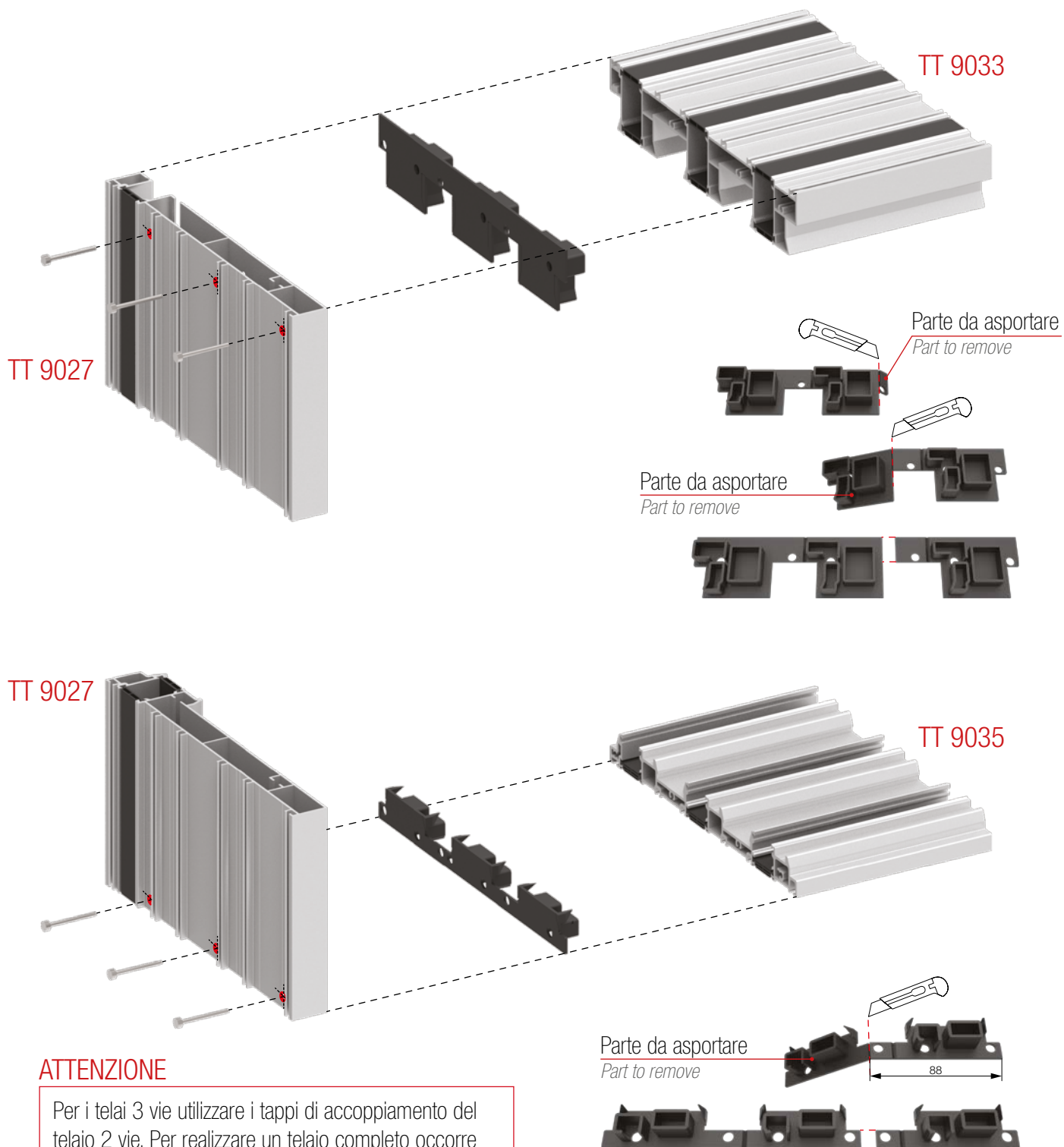

ATTENZIONE

Per i telai 3 vie utilizzare i tappi di accoppiamento del telaio 2 vie. Per realizzare un telaio completo occorre utilizzare i tappi contenuti nel kit ACP 9033M, più altri 4 tappi uguali da richiedere separatamente

For the 3-rail frames matching, use 2-rail matching plugs. To make a complete frame, use plugs included in the kit ACP 9033 plus 4 equal plugs that have to be ordered separately

M5

Montaggio soglie indipendenti, 2 ante (1 fissa + 1 apribile)

Stand-alone sill assembly, 2 sash (1 fixed + 1 openable)

Per realizzare uno scorrevole alzante a due ante, di cui una fissa, si consiglia di usare la soglia TT 9005 (1 per ogni anta) seguendo lo schema indicato, ovvero: in corrispondenza dell'anta mobile avrà larghezza totale, mentre per l'anta fissa il profilo soglia avrà lunghezza pari a L/2

Sill profile TT 9005 (one for each sash) is recommended for a lift and slide window with an openable sash and a fixed one

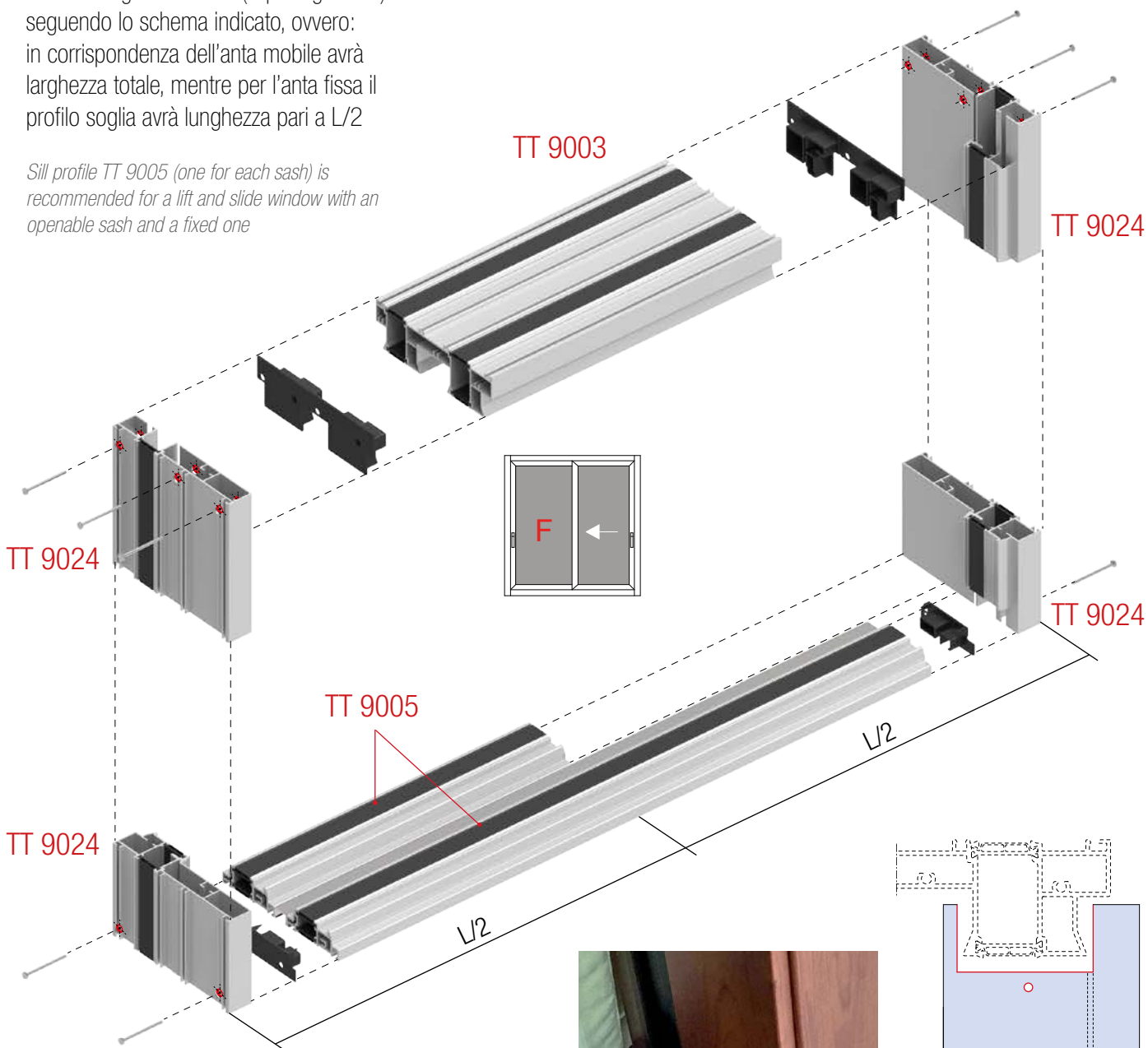

Il profilo SL 20913 dovrà coprire il profilo soglia andando fino a pavimento, previa sigillatura delle parti di contatto, come indicato a lato

SL 20913 profile must cover the sill profile reaching the floor and being sealed to it

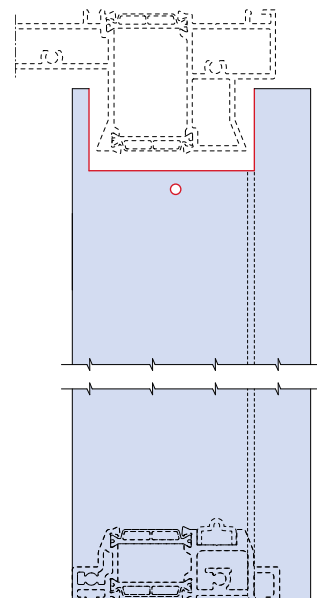

M6

Montaggio soglie basse indipendenti, 2 ante (1 fissa + 1 apribile)

Stand-alone low sill assembly, 2 sash (1 fixed + 1 openable)

Per realizzare uno scorrevole alzante a due ante, di cui una fissa, si consiglia di usare la soglia SL 20907 (1 per ogni anta) seguendo lo schema indicato, ovvero: in corrispondenza dell'anta mobile avrà larghezza totale, mentre per l'anta fissa il profilo soglia avrà lunghezza pari a L/2

Sill profile SL 20907 (one for each sash) is recommended for a lift and slide window with an openable sash and a fixed one

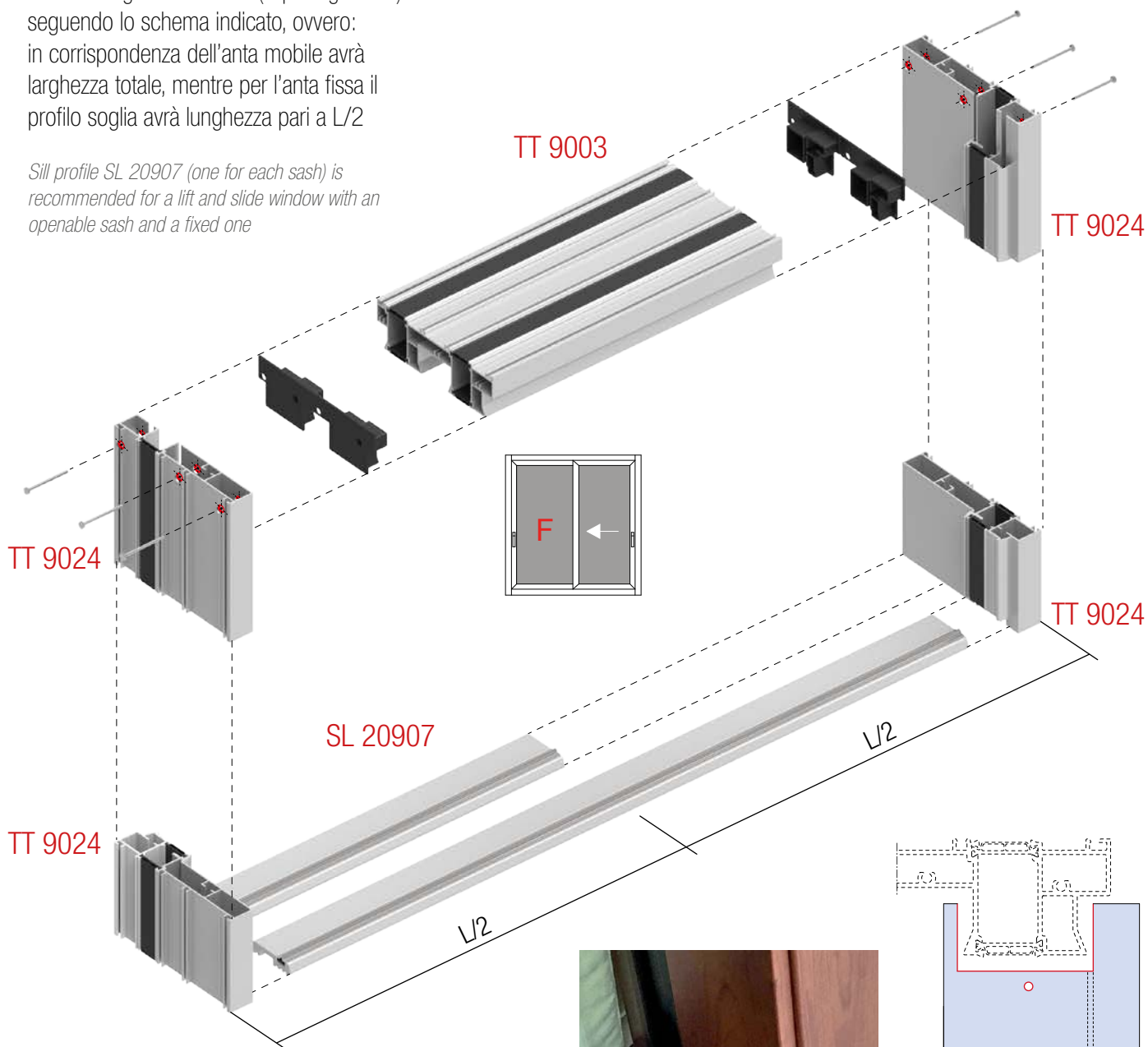

Il profilo SL 20913 dovrà coprire il profilo soglia andando fino a pavimento, previa sigillatura delle parti di contatto, come indicato a lato

SL 20913 profile must cover the sill profile reaching the floor and being sealed to it

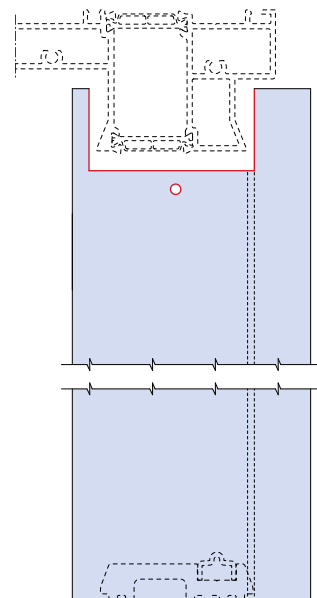

M6

ACP 9033M montaggio tappi copri lavorazione

ACP 9033M assembly cover machining-plug



TT 90812

Montare i tappi in cantiere dopo aver montato le ante, utilizzando le viti TSP 4x13mm

Plugs have to be in sealed on the site after having assembled sashes, by mean of TSP 4x13mm screw

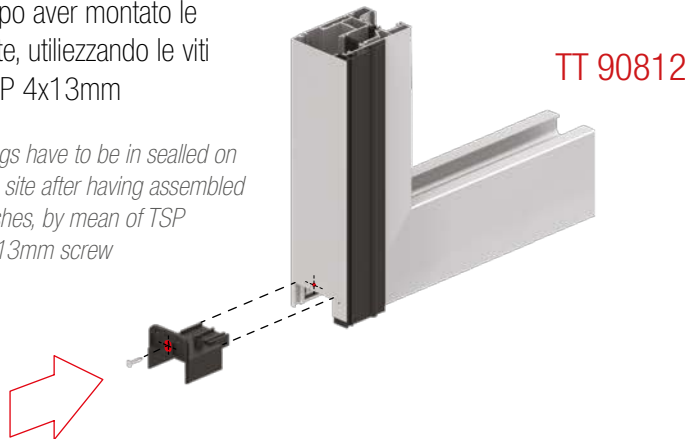

TT 90812

La spugna superiore, presente nel kit ACP 9035M, è distinguibile dalla presenza di due materiali e due colori e con la parte vellutata rivolta verso l'alto

Upper sponge included within AC 9033M set is characterized by the presence of two materials and two colors, with velvety upward surface

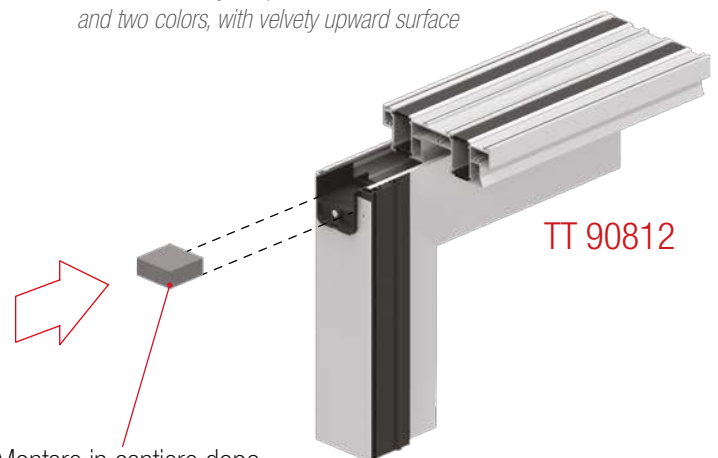

TT 9003

Montare in cantiere dopo aver posato le ante

Put in construction site after sashes assembly



TT 9003

Montare in cantiere dopo aver posato le ante

Put in construction site after sashes assembly

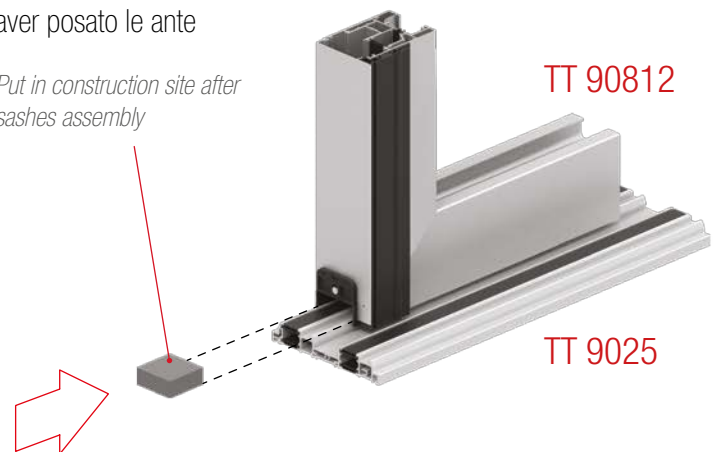

TT 90812

TT 9025

La spugna inferiore, presente nel kit ACP 9025M, è distinguibile perchè è monomaterica

Lower sponge included in ACP 9025M set is a monomaterial one



TT 90812

TT 9025

M7

ACP 9033M squadretta allineamento

Allignment corner joint ACP 9033M

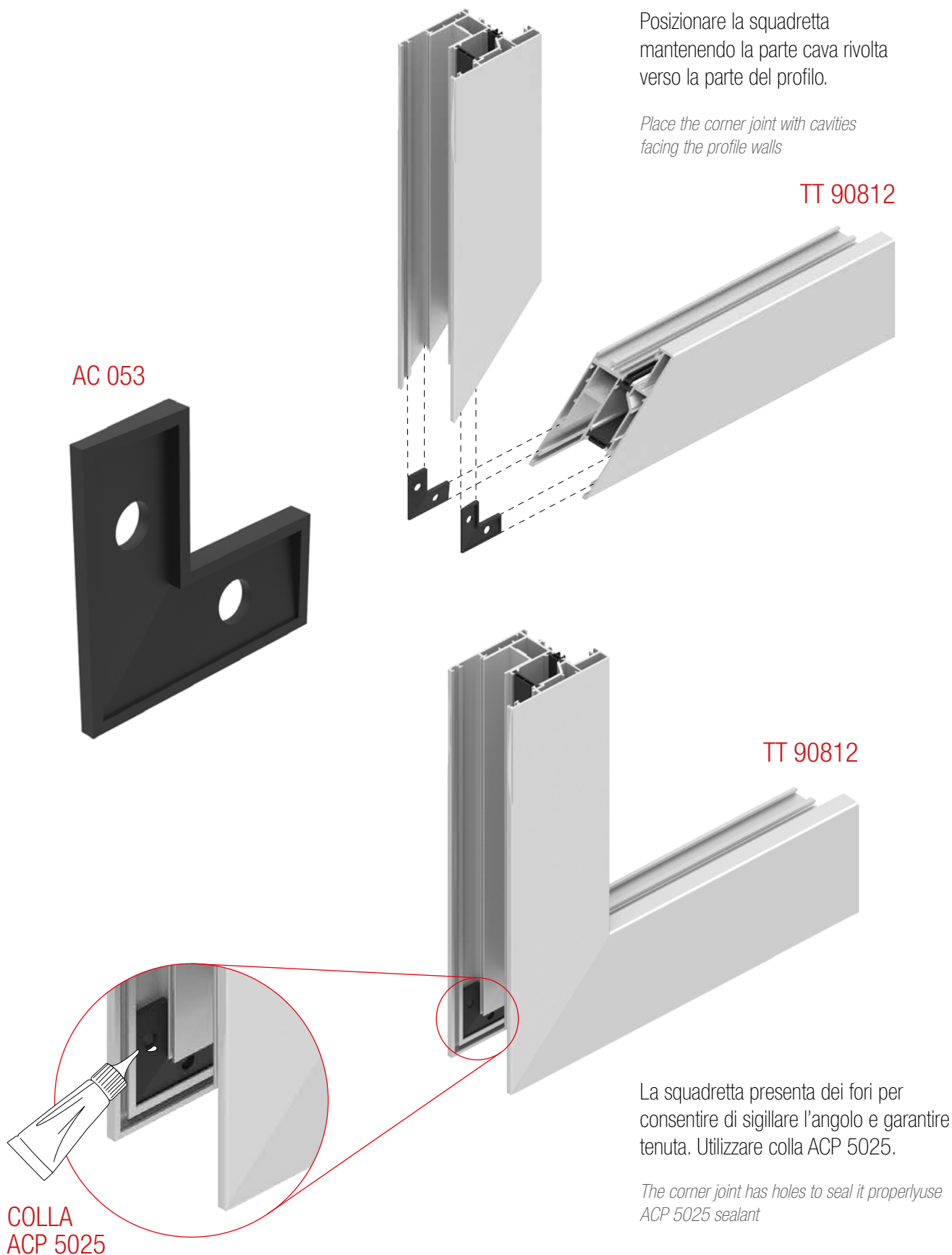

M8

ACP 9033M pattino guida anta *Alignment skate, top rail ACP 9033M*

TT 9003

TT 90811

ABBASSATA

ALZATA

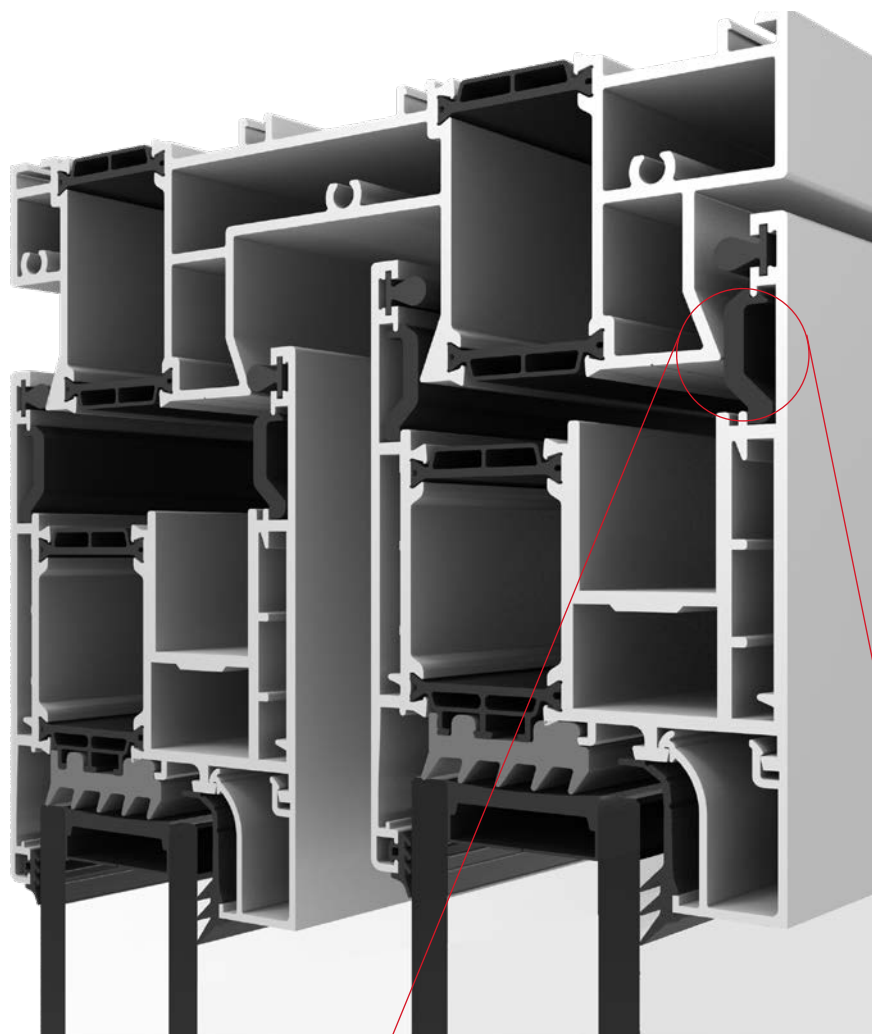

L'accessorio ha la funzione di guidare l'anta, mentre si alza in fase di apertura e mantenerla nella posizione corretta durante lo scorrimento

The skate guides the sash while it lifts itself in the opening phase and keep it in its seat while scrolling

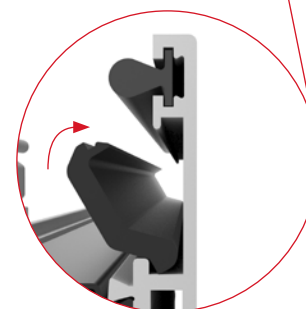
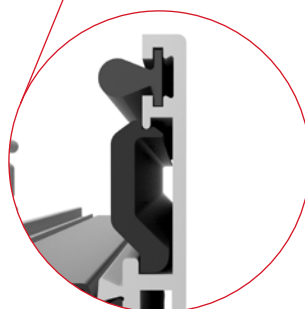

AC 054

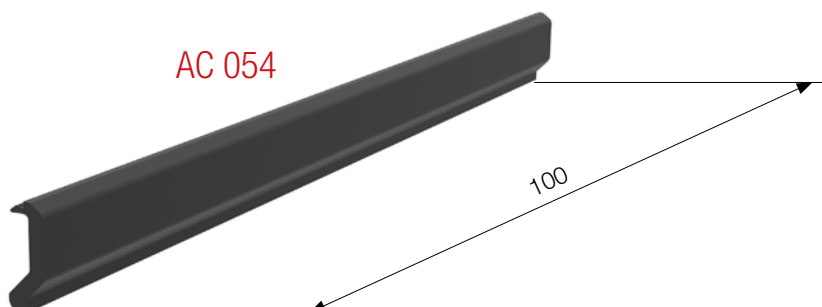

M9

ACP 9035M montaggio elementi di tenuta centrale

ACP 9035M central watertightness elements

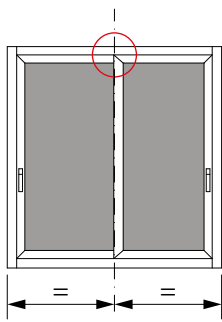

TT 9003

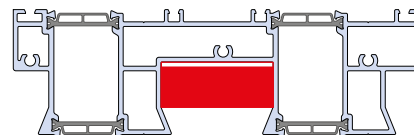

1

Montare la spugna in officina perfettamente al centro del traverso superiore

Put the seal in lab perfectly in the middle of upper beam

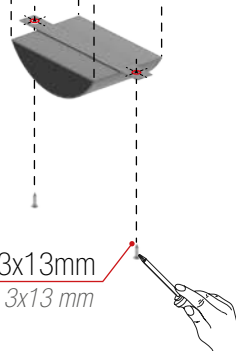

Vite TSP 3x13mm
Screw TSP 3x13 mm

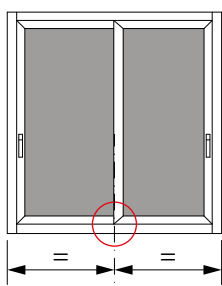

Membrana adesiva
Adhesive membrane

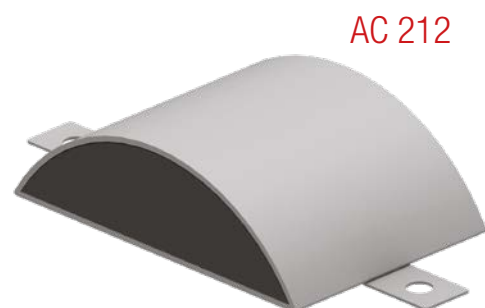
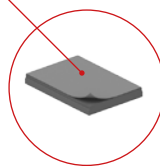

AC 212

2

Togliere la membrana adesiva e montare la spugna in officina perfettamente al centro della soglia

Remove the adhesive membrane and put the seal in lab perfectly in the middle of treshold

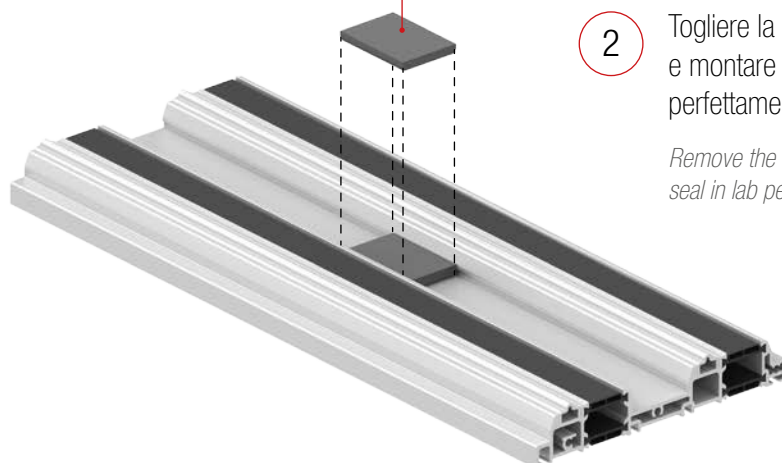

TT 9025

M10

ACP 9029 tappo chiusura ante frontali

ACP 9029 closure plug, frontal leaf

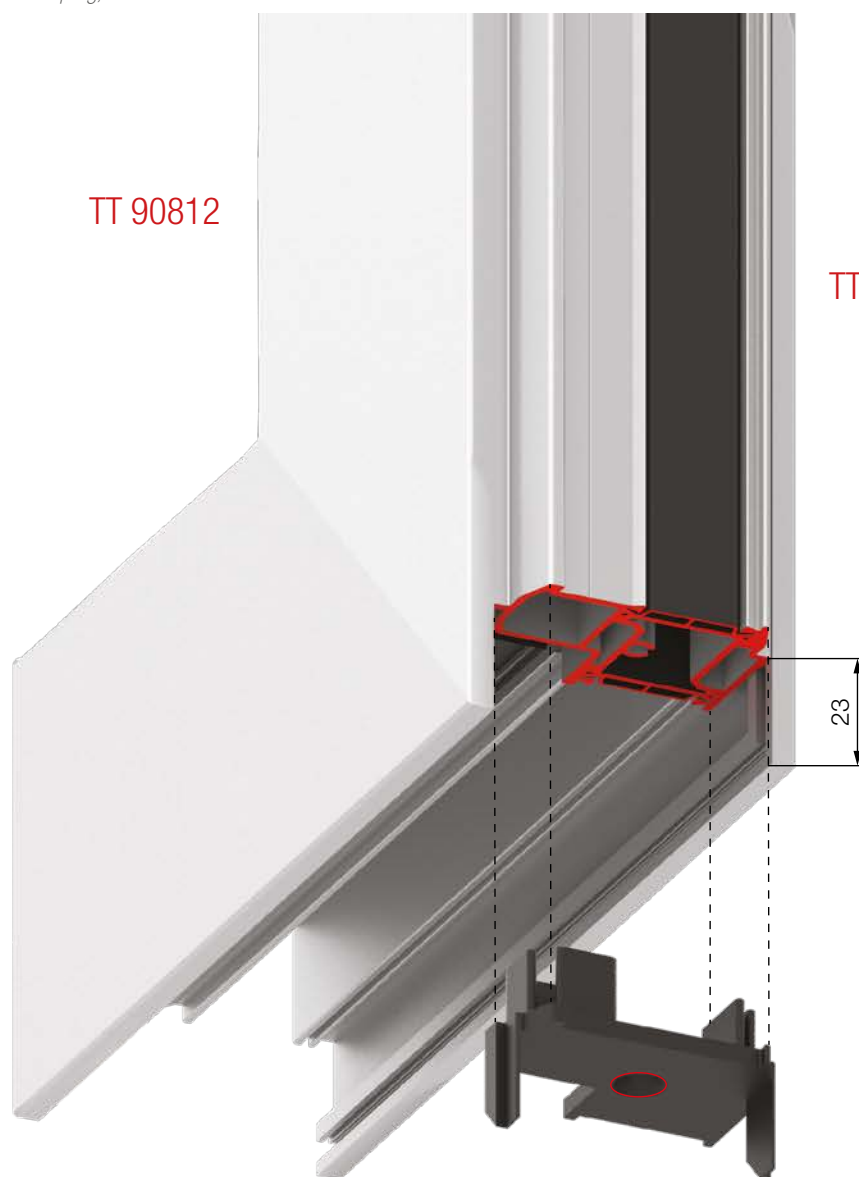

TT 90812

TT 9014

ATTENZIONE

Nella tipologia con ante che scorrono sullo stesso binario con chiusura frontale, i tappi vanno applicati sul profilo TT 9014 sia nella parte superiore che in quella inferiore. Prima di inserire i tappi occorre sigillare il profilo nella zona dove andranno montati e poi andrà fissato con viti TSP Ø 4,8mm

With sash that slide on the same rail, with frontal closure, plugs should be applied on the profile TT 9014 is both on the top and bottom. Before inserting the plugs, you must seal the profile zone where it will be put and then it will be fixed with screws TSP Ø 4.8 mm



ACP 9029

M11

ACP 9030/AGP 40131 applicazione supporto vetro e isolamento vetro

ACP 9030 / AGP 40131 glass support and insulation application

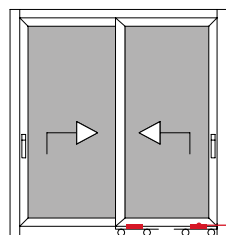

ACP 9030

APPOGGI VETRO	
Codice	Spessore (mm)
SA 2902NG	2
SA 2903NR	3
SA 2904NB	4
SA 2905NN	5

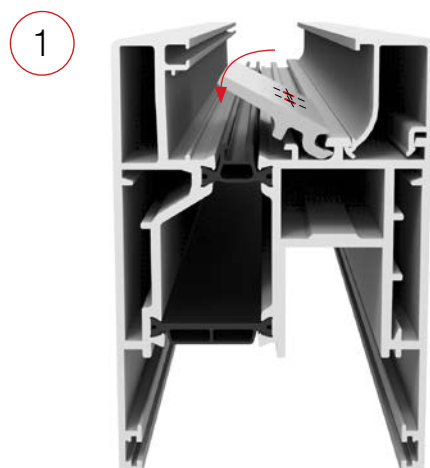

1

ATTENZIONE

Il supporto vetro ACP 9030 deve essere montato sulle ante, in asse rispetto ai carrelli. In aggiunta all'ACP 9030 occorre obbligatoriamente, montare l'appoggio vetro in nylon da tabella sotto

The glass support ACP 9030 must be applied on the leaf, in the centre of the rail. In addition to ACP 9030, the nylon glass support must be assembled as the table below

TT 90812

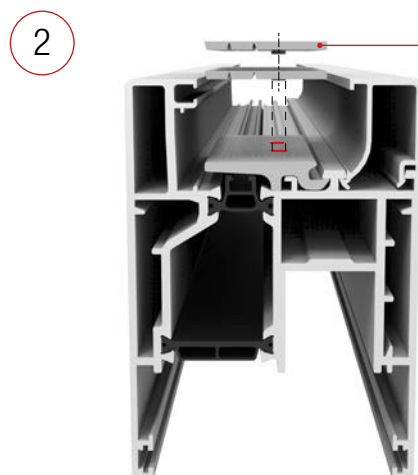

2

All'occorrenza si possono utilizzare spessori sovrapposti

Use superimposed thickness

TT 90812

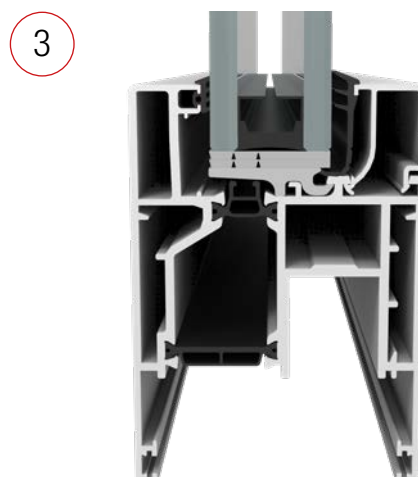

3

TT 90812

SA 2902NG
SA 2903NR
SA 2904NB
SA 2905NN

ACP 9030

TT 90812

Interrompere l'isolamento vetro AGP 40131 in corrispondenza dello spessore ACP 9030

Cut off AGP 40131 insulating strip to fit ACP 9030 block

M12

ACP 9036 distanziale anta fissa

ACP 9036 fixed leaf spacer

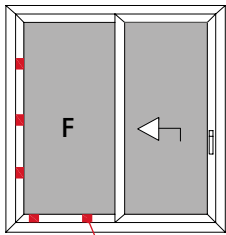

Il distanziale ACP 9036 serve a dare la posizione corretta dell'anta fissa, che verrà poi avvitata al telaio

The spacer ACP 9036 gives the correct position to leaf, which is screwed to the frame

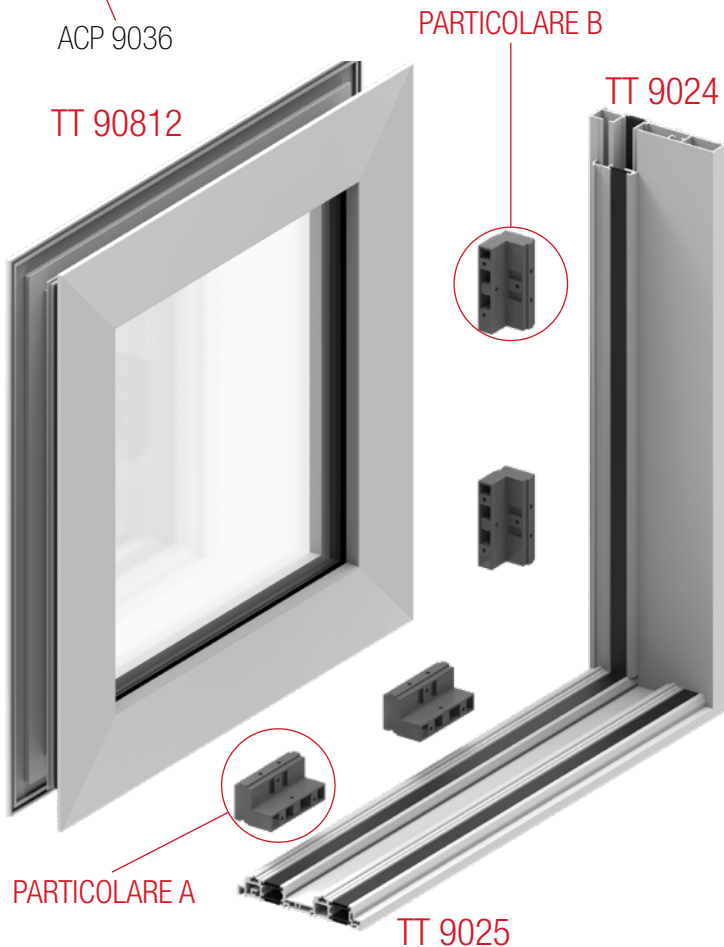

PARTICOLARE A

PARTICOLARE A

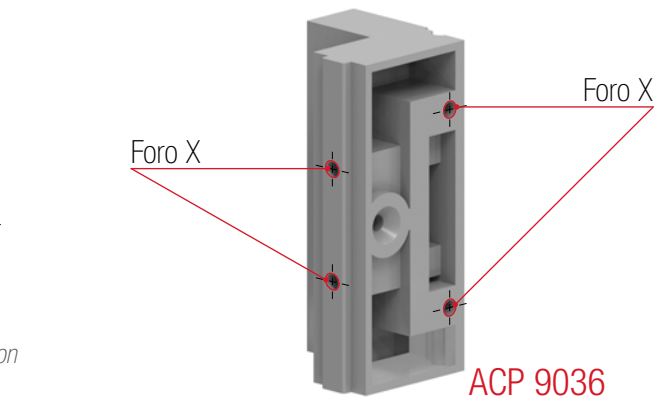
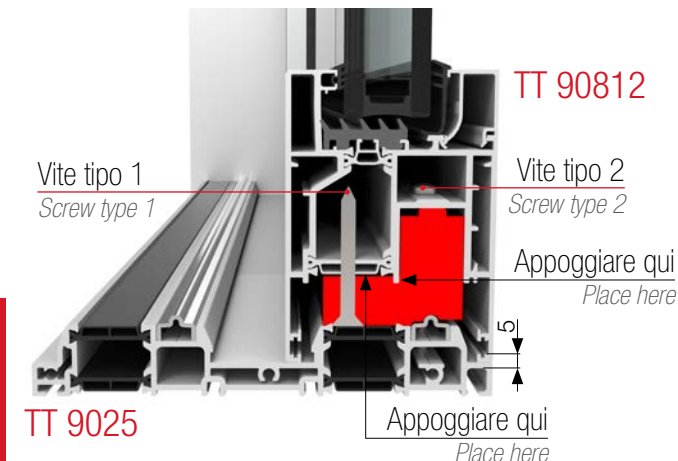

- 1 Posizionare il distanziale sull'anta (1 ogni 60cm circa), lungo i lati che vanno contro il telaio e fissarlo con viti di tipo 1. Per un corretto inserimento del distanziale appoggiare alle pareti del profilo come indicato dalle frecce nei particolari A e B

Put the spacer on the leaf (1 each about 60cm), along the sides against the frame, as diagram shown and fix it with screws type 1. For a correct insertion of the spacer, place it on the profile as indicated by arrows in the A and B details

- 2 Per marcare i punti dove andrà fissata l'anta al telaio, praticare i fori sull'anta passanti attraverso il foro X del distanziale

To mark the points where the leaf will be fixed to the frame, drill the leaf in the hole "X" of the spacer

- 3 Posizionare l'anta sul telaio e fissarla attraverso i fori già realizzati con le viti di tipo 2

Put the leaf on the frame and fix it with screws type 2

- 4 Vetrare l'anta come da procedura standard

Put the glass following the standard procedure

LEGENDA VITI:
 Tipo 1 = TSP 4,8x45mm

 Tipo 2 = TSP 4,8x70mm

PARTICOLARE B

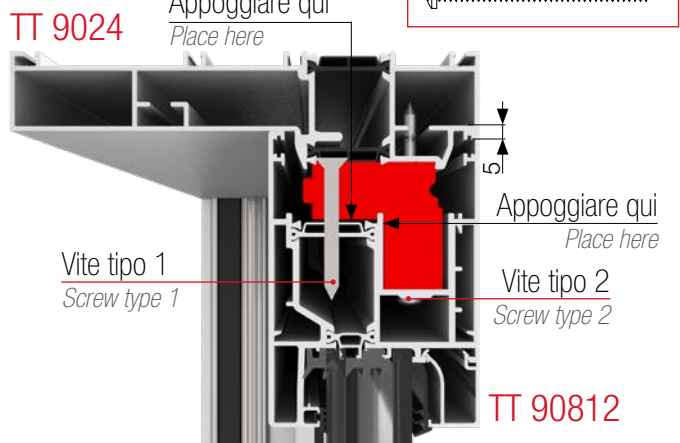

M13

ACP 9037 applicazione blocchetto antisollevamento

ACP 9037 burglary block assembly

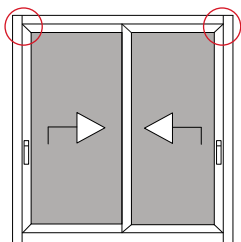

TT 9003

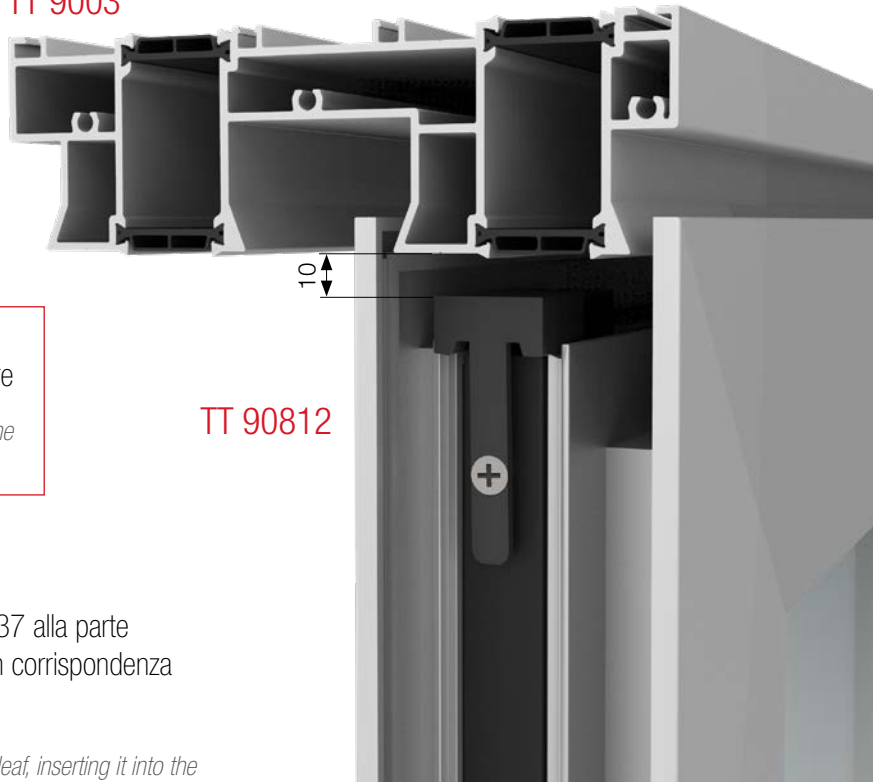

ATTENZIONE

Il montaggio del blocchetto antisollevamento va effettuato dopo aver posizionato l'anta in cantiere

The block has to be assembled after the positioning of the leaf in the construction site

- 1 È sufficiente appoggiare ACP 9037 alla parte superiore dell'anta, inserendolo in corrispondenza della barretta in poliammide

Just place ACP 9037 at the top of the leaf, inserting it into the space of the polyamide strip



ACP 9037

Vite autofilettante TSP 4,2x15
self-threading screw TSP 4.2x15

TT 90812

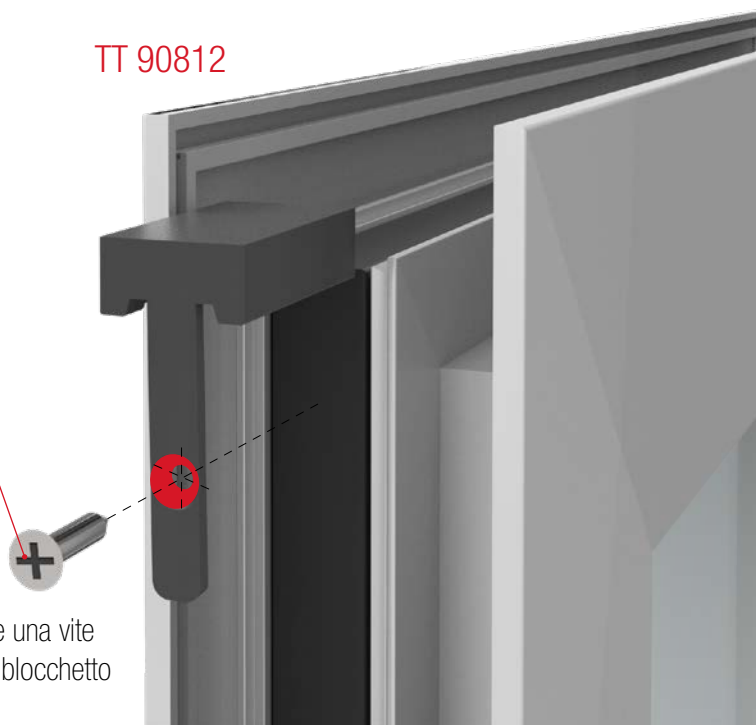

- 2 Infine fissare ACP 9037 frontalmente tramite una vite autofilettante TSP 4,2x15 mm. Utilizzare un blocchetto per anta, nell'angolo superiore lato maniglia

*Finally fixit ACP 9037 with a self-threading screw TSP 4.2x15 mm.
Use a block per leaf, in the top corner of the frame*

M14

ACP 9040 bloccetto per inserimento coprifuga

L'accessorio ACP 9040 deve essere collocato perpendicolarmente nella direzione del lato più lungo sul profilo SL 20914 e serve a posizionare e distanziare i telai del fisso dal monovia, superiormente e lateralmente, permette inoltre di ricevere a scatto il profilo di finitura SL 20914. Nella parte inferiore tra le due soglie, utilizzare solo il profilo SL 20914 senza bloccetti.

Small block for the insertion of the cover-space - ACP 9040 must be placed perpendicular in the direction of the longest side on the profile SL 20914 and helps to put and separate at the top and laterally the fixed frames and 1-rail ones. It also allows to snap the finishing profile SL 20914. In the bottom, between the two thresholds, use just the profile SL 20914 without blocks.

Nodo superiore

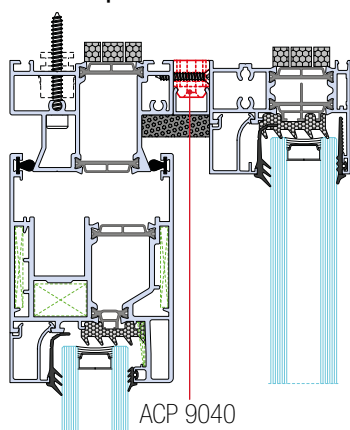

Nodo laterale

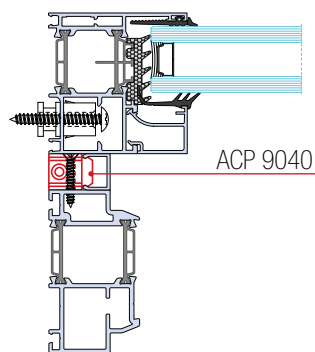

Nodo soglia

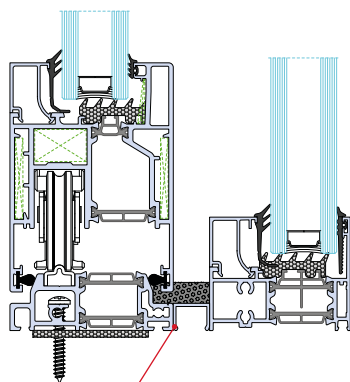

Sigillare prima di mettere il profilo SL 20914

Seal before putting the profile SL20914

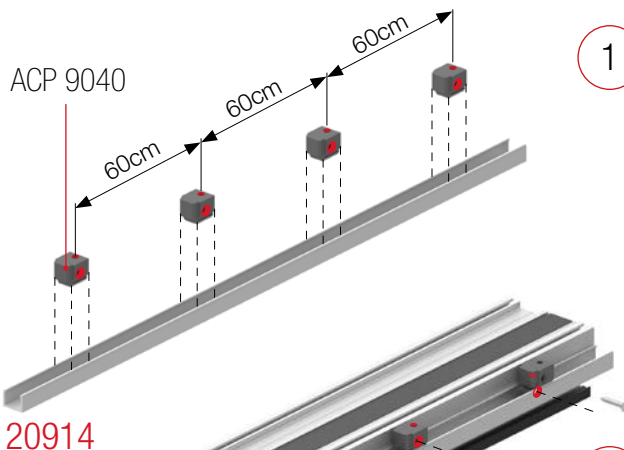

SL 20914

1

Inserire ACP 9040 lungo il profilo SL 20914 ad una distanza di 60cm circa l'uno dell'altro

Insert ACP 9040 on the profile SL 20914. Place them at the ends of the bar each 60cm

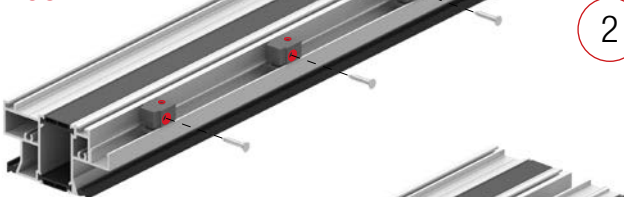

TT 9004

2

Appoggiare la barra al telaio e fissarla con le viti attraverso i bloccetti ACP 9040

Put the bar in contact to the frame and fix it with the screws using the blocks ACP 9040



TT 61165

3

Montare il telaio fisso appoggiandolo al profilo coprifuga

Assemble the fixed frame, place it on the cover profile

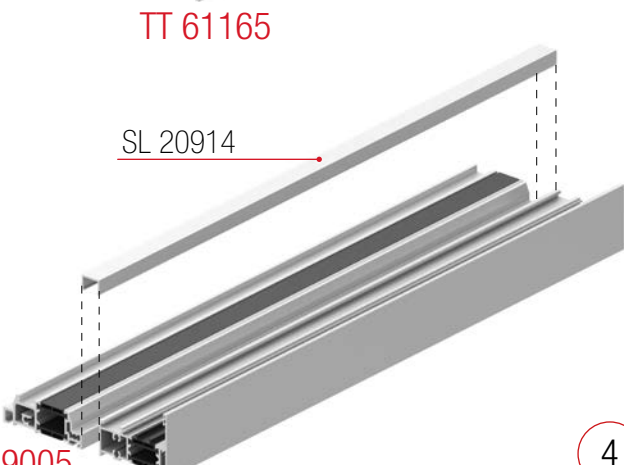

SL 20914

TT 9005

TT 6183

4

Infine inserire il profilo SL 20914 tra le soglie

Finally, insert the profile SL 20914 between the thresholds

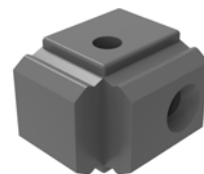

ACP 9040

M15

Spugna per scorrevole monovia

Seal for lift and side window 1 rail

ATTENZIONE

Quando si ha uno scorrevole monovia a scrigno occorre ricavare quattro porzioni di ACP 8042 per chiudere gli spazi agli angoli

For concealed single rail sashes, use 4 pieces of ACP 8048 to close corner gaps

ATTENZIONE

Resterà un piccolo spazio utile al sollevamento dell'anta

A small space will remain in order to lift the sash

- 1 Asportare due porzioni da 9x10mm da ACP 8042 incollandoli al telaio nella parte inferiore, come indicato

Cut Two 9x10mm pieces from ACP 8048, and fix them on the lower part of the frame as shown

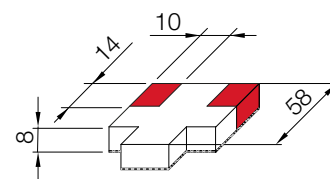
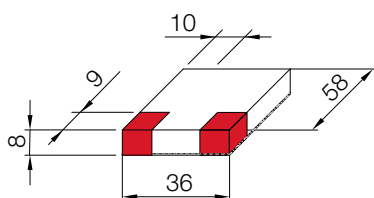

- 2 Asportare due porzioni da 14x10mm da ACP 8042 incollandoli al telaio nella parte superiore, come indicato.

Cut two 14x10mm pieces from ACP 8048, and fix them on the lower part of the frame as shown

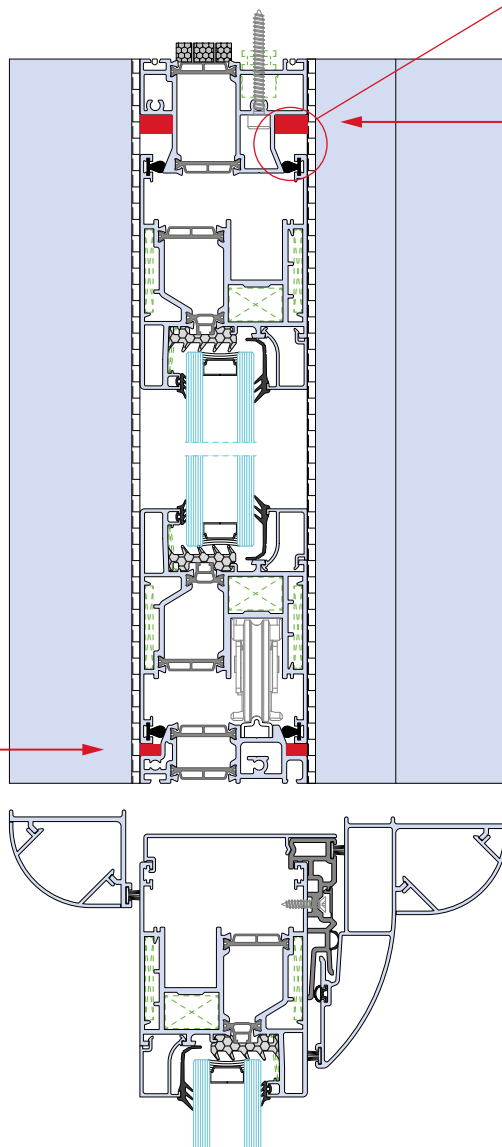

M16

Composizione kit ACP 90118M e ACP 90118M/R

ACP 90118M and ACP 90118M/R B.O.M.

2 pz (12,5mm)	4,8 x 16 inox (UNI 6955) (4 pz)	4 pz (20mm)	1 pz	4,8 x 50 inox (UNI 6956) (8 pz x aste comando)

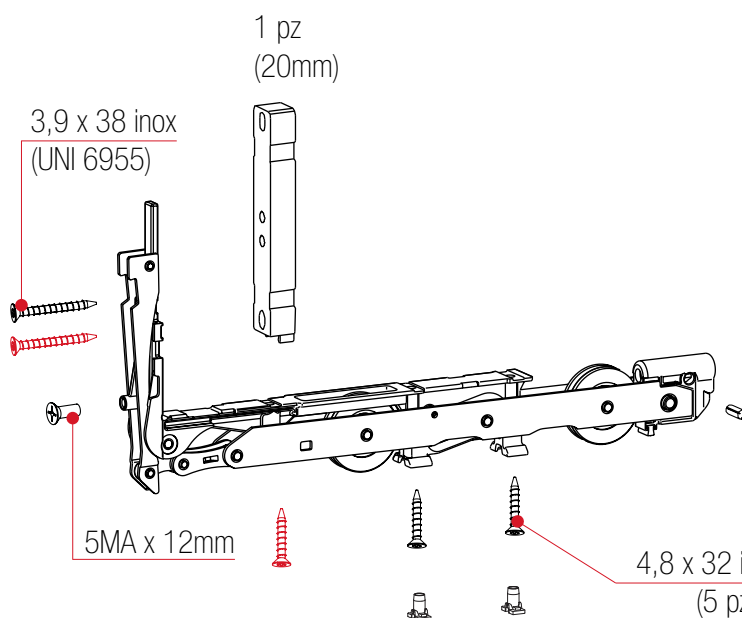

KIT ACP 90118M

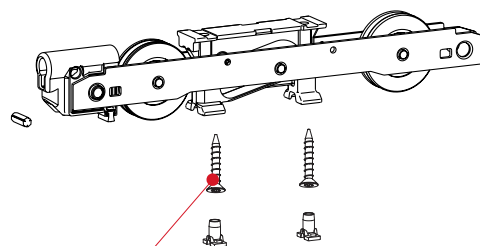

KIT ACP 90118M/R

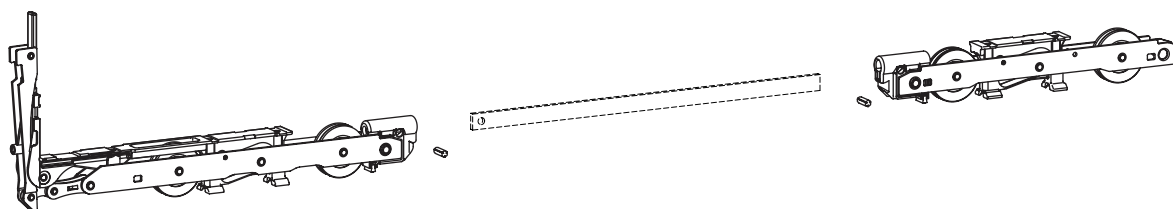
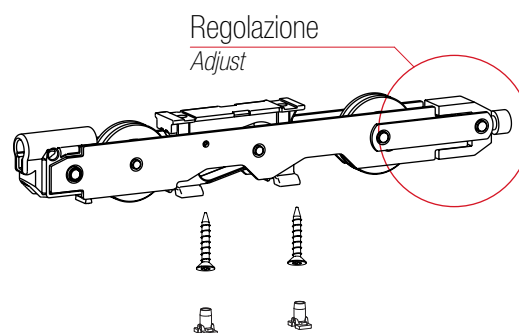

M17

Ferramenta per alzante

Lift and slide hardware

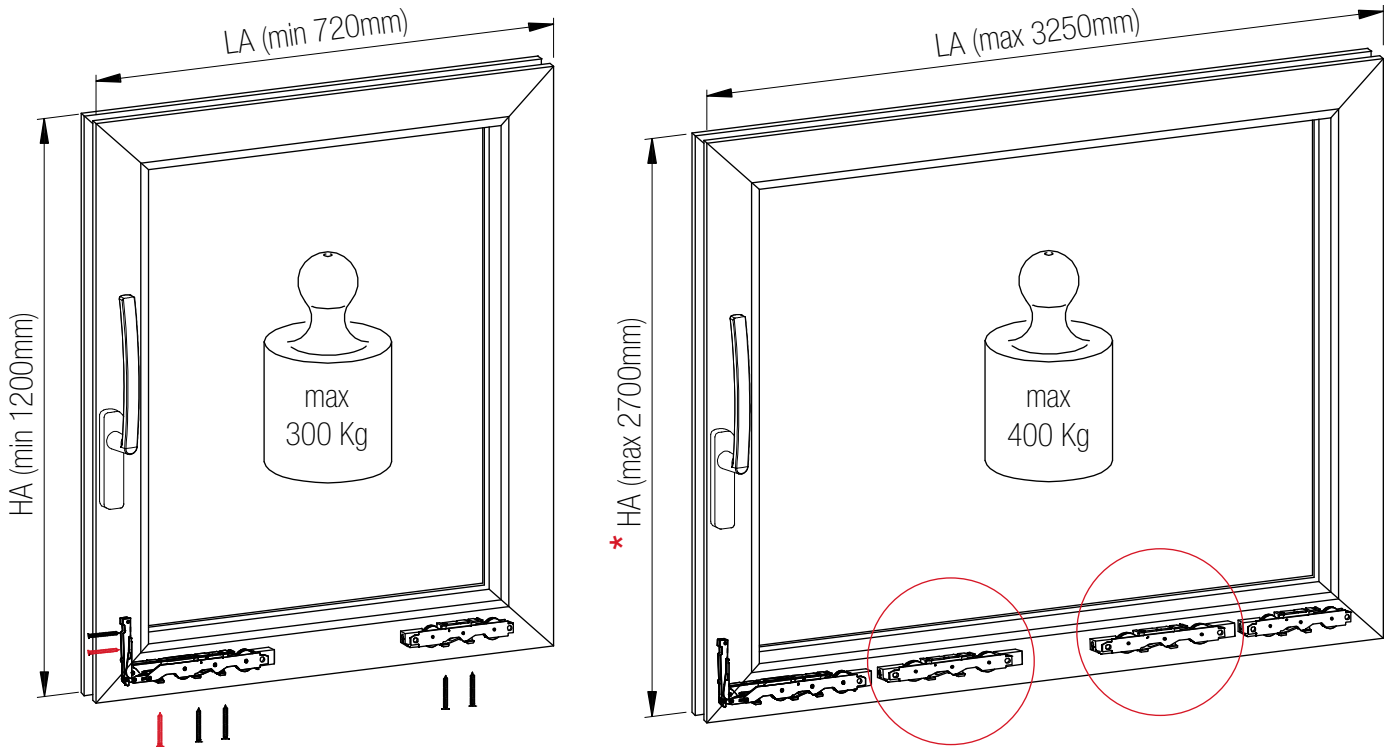

*** Elevabile fino a 3000mm
con la prolunga dell'asta**

*Up to 3000mm with rod
extension*

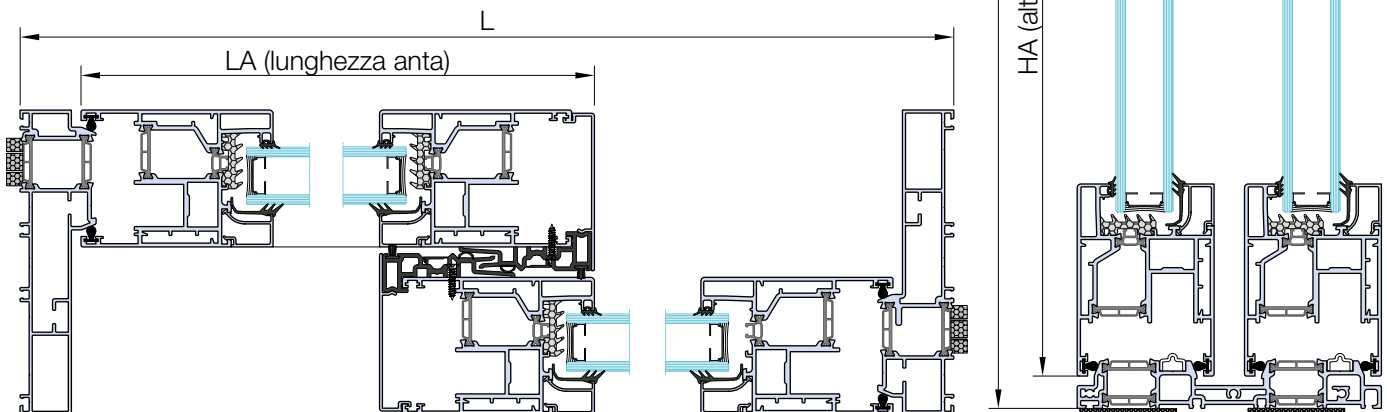
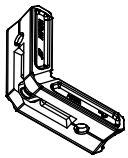

LA

HA

Codice	Altezza anta (HA)	(HM)
ACP 90113M/1785	1200 - 1785mm	407 mm
ACP 90113M/2100	1786 - 2100mm	1007 mm
ACP 90113M/2400	2101 - 2400mm	1007 mm
ACP 90113M/2685	2401 - 2700mm	1007 mm

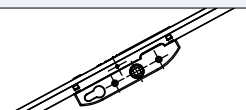

Codice	(L)	(LA)
ACP 90112M/898	898 mm	max 1500mm
ACP 90112M/1898	1898 mm	max 2500mm
ACP 90112M/2898	2898 mm	max 3250mm

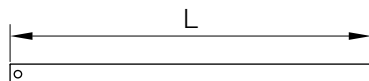

HM

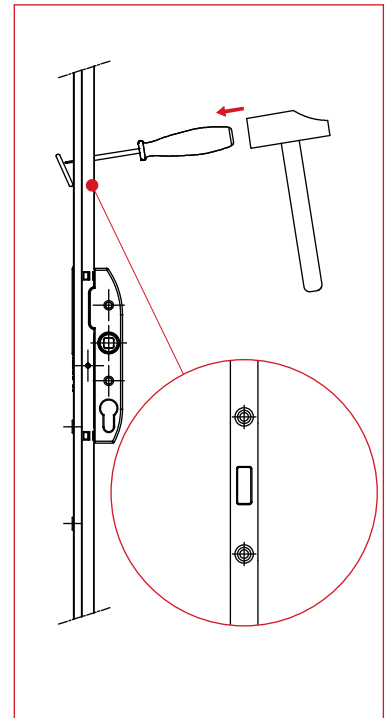
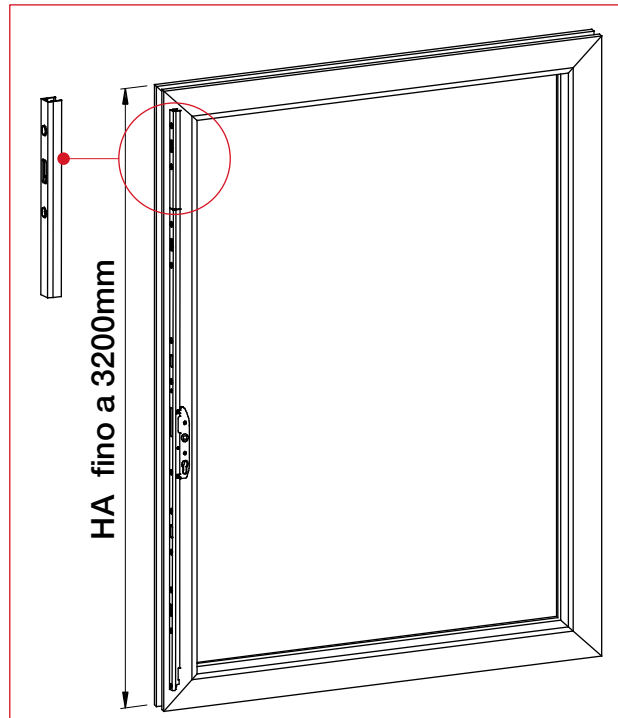
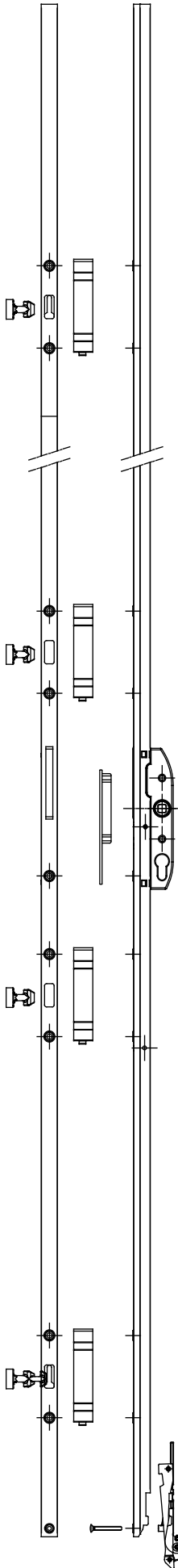

Per le chiusure centrali, rimuovere il lamierino pretranciato

Remove precut metal sheet when using additional central locks

MONTAGGIO MOLLA / SPRING FITTING

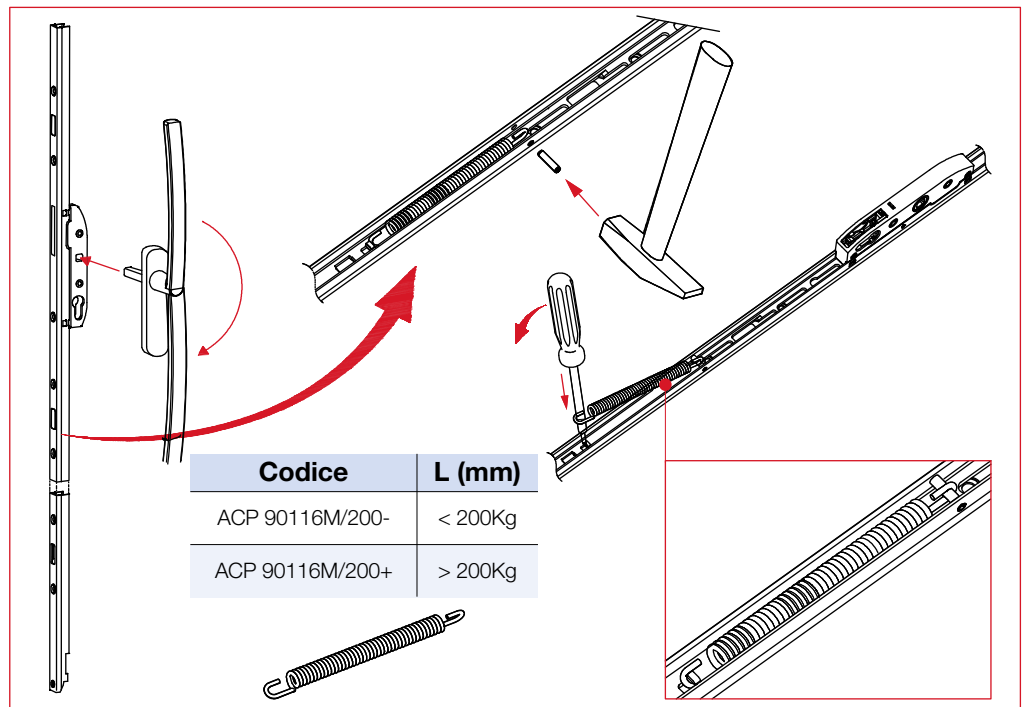

Codice	L (mm)
ACP 90116M/200-	< 200Kg
ACP 90116M/200+	> 200Kg

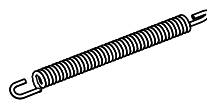

LA - 700mm

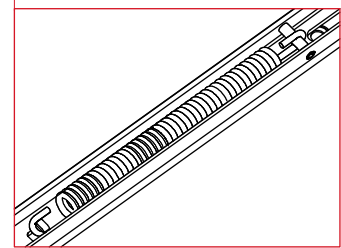

FUORI SCALA

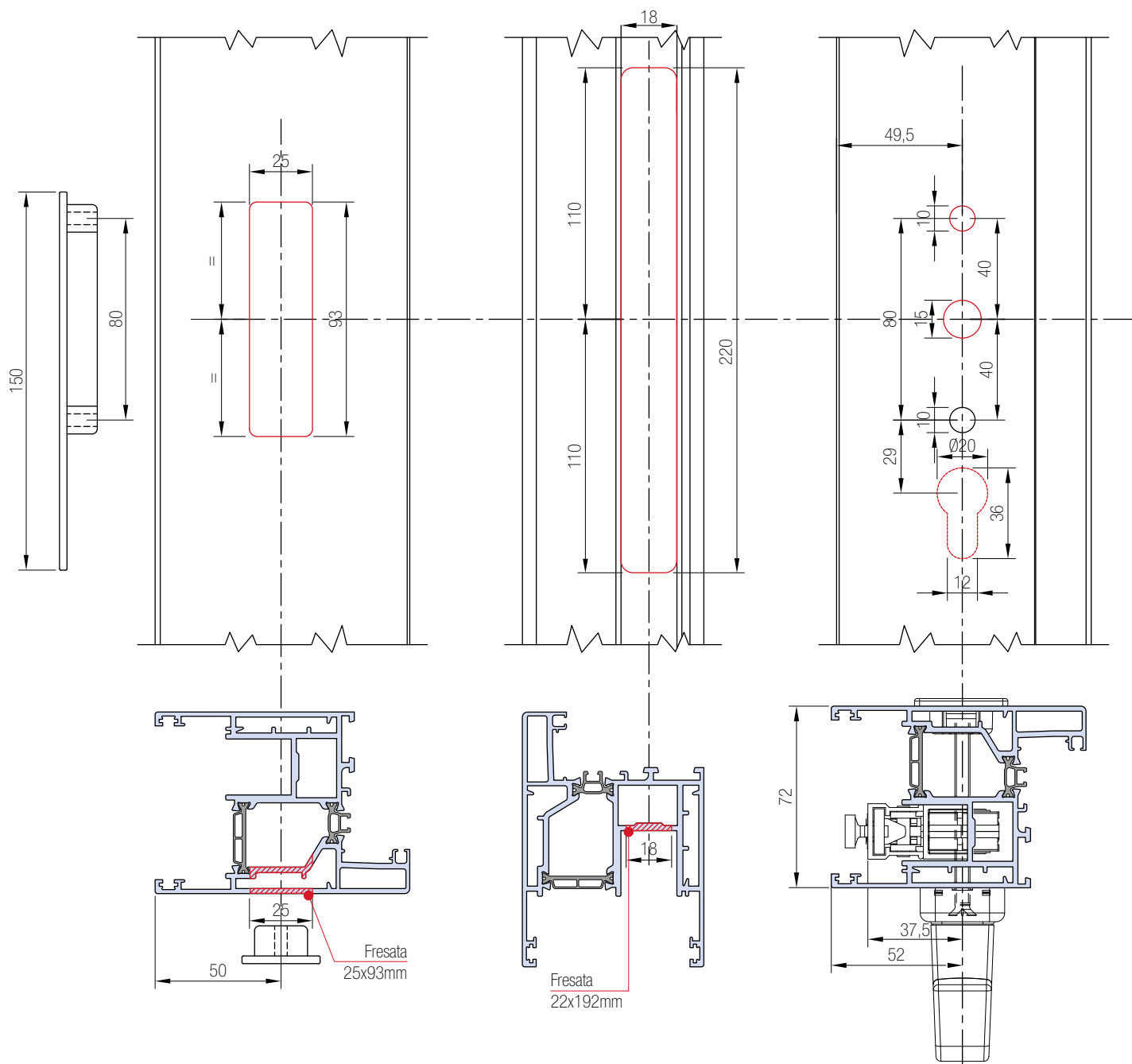

Coppia carrelli aggiuntivi per un peso anta fino a 400Kg
Additional rollers for weight up to 400Kg

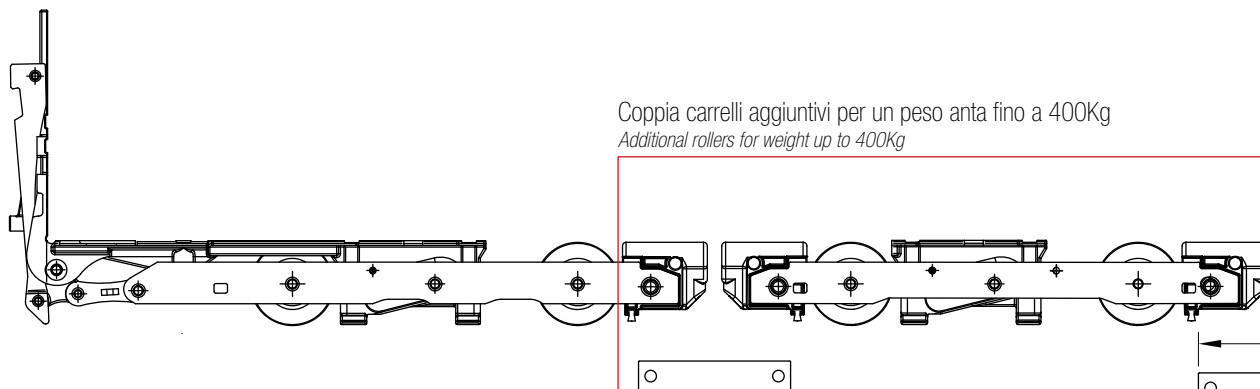

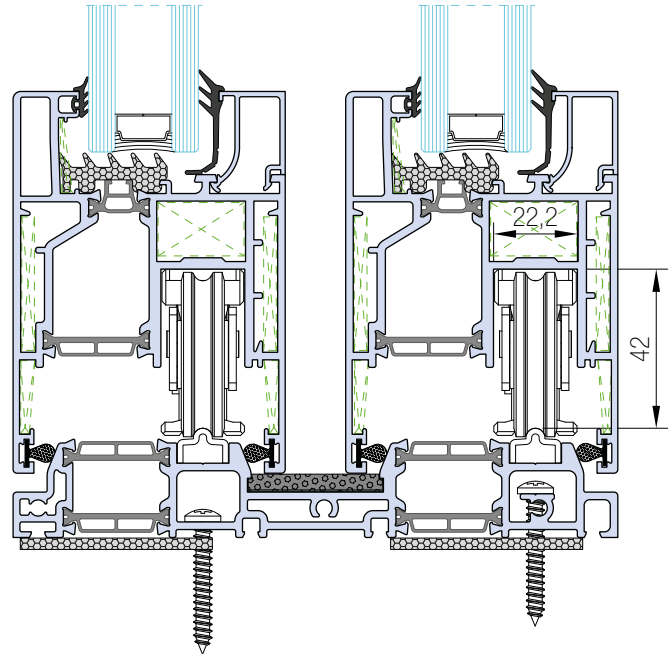
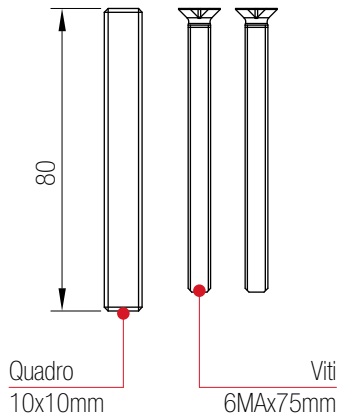
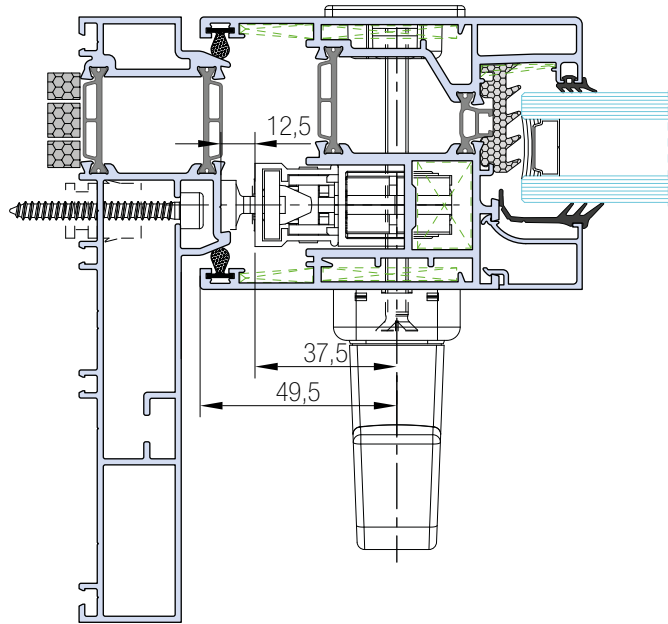
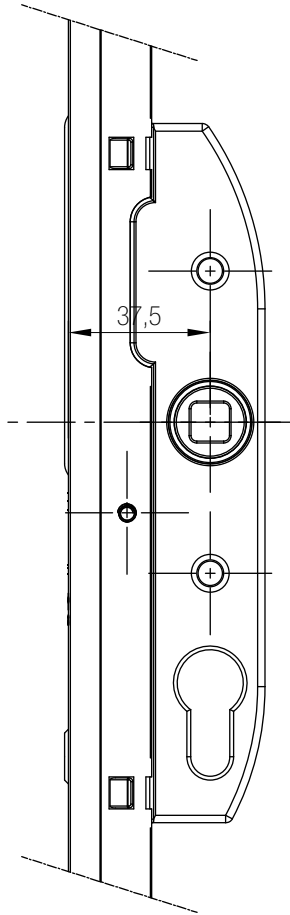

LA - 1300mm

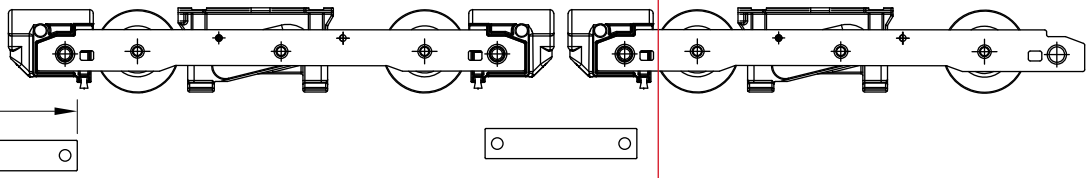

REGOLAZIONE CARRELLO / ADJUSTABLE ROLLER

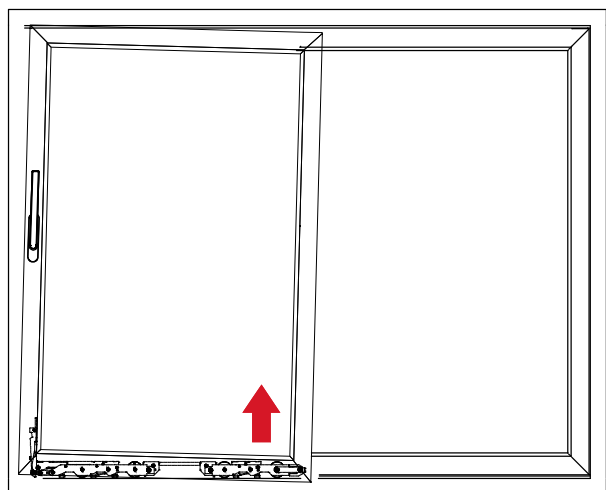

Modello con regolazione
Adjust model

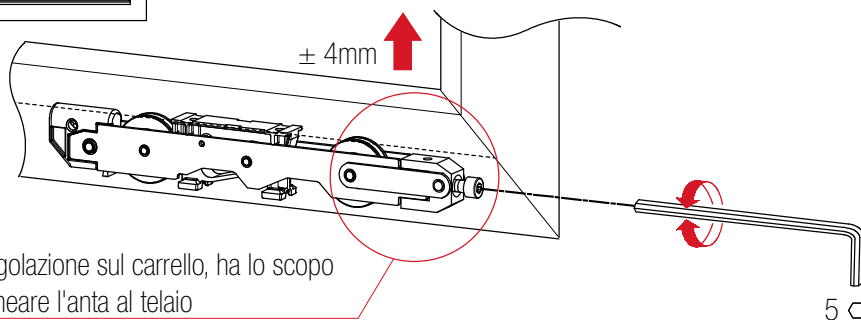
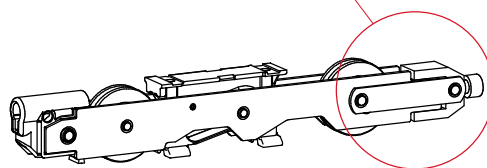

La regolazione sul carrello, ha lo scopo di allineare l'anta al telaio
Adjust the roller to align sash and frame

50

ISTRUZIONE PARACOLPO / BLOCKING DEVICE INSTRUCTION

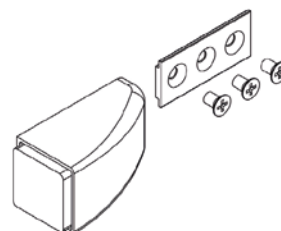
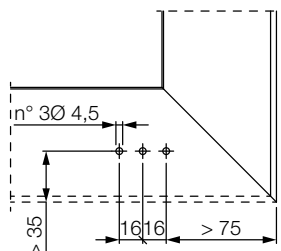
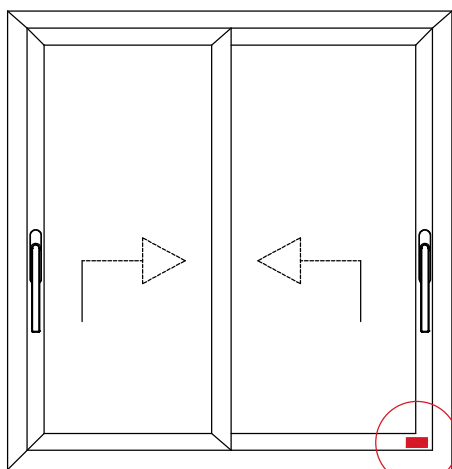

ACP 8043

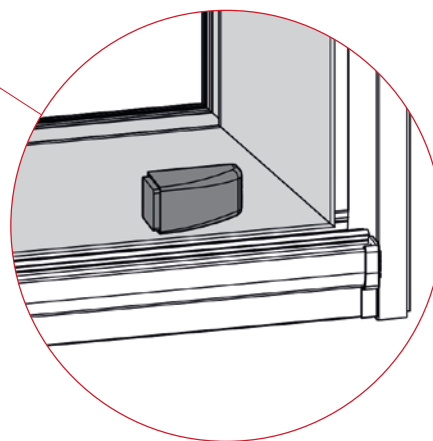
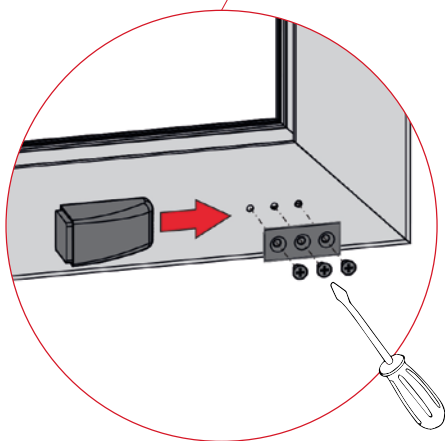



Info prodotto 2105

2.10.2021

alsistem.com

TOP SLIDE 160 PLUS

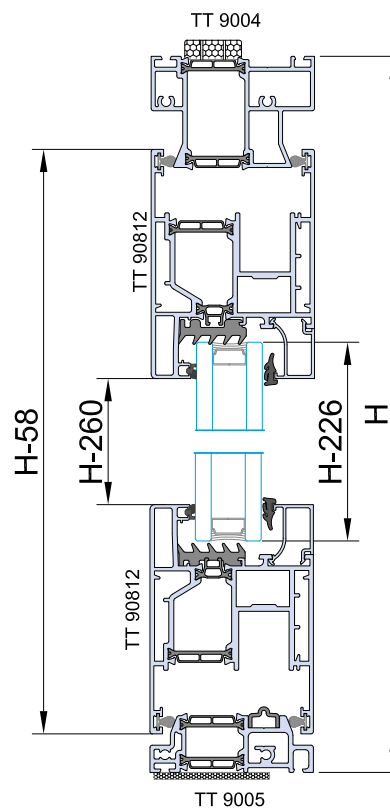
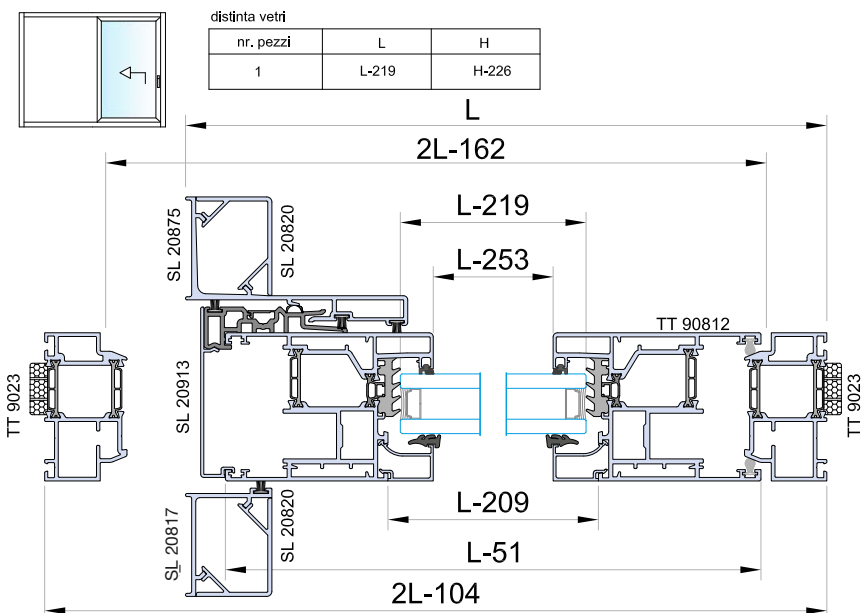

Profiles' list Distinta profili

Art.	Descrizione	Pezzi	Misura	Taglio
TT9023	Montante telaio <i>Mullion frame</i>	2	H	
TT9005	Traverso inferiore telaio <i>Transome bottom frame</i>	1	2L-162	
TT9004	Traverso superiore telaio <i>Transome upper frame</i>	1	2L-162	
TT90812	Traverso anta <i>Transom sash</i>	2	L-51	
	Montante anta <i>Mullion sash</i>	2	H-58	
SL 20913	Montante riparto cen. <i>Mullion astragal</i>	1	H-58	
SL20817	Mont. chiusura monovia <i>Mullion closure 1-rail</i>	1	H	
SL 20875	Mont. chiusura monovia <i>Mullion closure 1-rail</i>	1	H	
SL20820	Montante copri vite <i>Mullion cover screw</i>	2	H	
SX 9901	Binario in inox <i>Stainless steel guide</i>	1	2L-125	
PL 1418	Fermavetro <i>Glazin bead</i>	2	H-260	
	Fermavetro <i>Glazin bead</i>	2	L-209	

Gaskets' list Distinta guarnizioni

Art.	Descrizione	Pezzi	Misura
AGP 9005	Battuta <i>Rabbit gasket</i>	4	L-51 H-58
AGP 7007	Vetro esterna <i>External glass gasket</i>	2	L-219 H-226
AGP 4203	Vetro interna <i>Internal glass gasket</i>	2	L-219 H-226
AGP 5034/25	Isolamento spalla <i>Abutment insulation</i>	2	H L
AGP 5037	Isolamento muro <i>Wall insulation</i>	1	L
TAC 903	Incontro centrale <i>Incontro centrale</i>	2	H-58
AGP 8005	Spazzolino <i>Brush</i>	4	H-58
AGP 40131	Sotto Vetro <i>Glazing strip</i>	2	L-206
	Sotto Vetro <i>Glazing strip</i>	2	H-206

Accessories' list Distinta accessori

Art.	Descrizione	Q.tà
ACP 5801	Squadretta multifunzione <i>Multifunction corner cleat</i>	4
ACP 5001	Vite per ACP 5801 <i>Screw for ACP 5801</i>	8
ACP 50154	Squadretta multifunzione <i>Multifunction corner cleat</i>	8
ACP 5030	Spina per ACP 50154 <i>Dowel pin for ACP 50154</i>	16
ACP 9030	Supporto vetro <i>Glass support</i>	2
SA2904 NB	Appoggio vetro 4 mm <i>4mm glass backing</i>	2
ACP 50110	Squadretta allineamento anta <i>Alignment corner bracket</i>	4
ACP 90101	Maniglione alluminio con vaschetta <i>Handle + recessed handle</i>	1
ACP 90112M	Asta collegamento <i>Connection rod</i>	1
ACP 90113M	Asta movimento cremonese <i>Cremonese moving rod</i>	1
ACP 5036	Regolo <i>Spacer</i>	9
ACP 90118M	Kit base carrelli <i>Roller base kit</i>	1
ACP 9033M	Kit componenti plastici <i>Plastic elements kit</i>	1
ACP 9015	Catenaccio <i>Boit</i>	1



Info prodotto 2105

2.10.2021

it's my window

alsistem.com

TOP SLIDE 160 PLUS

Nodo a muro monovia

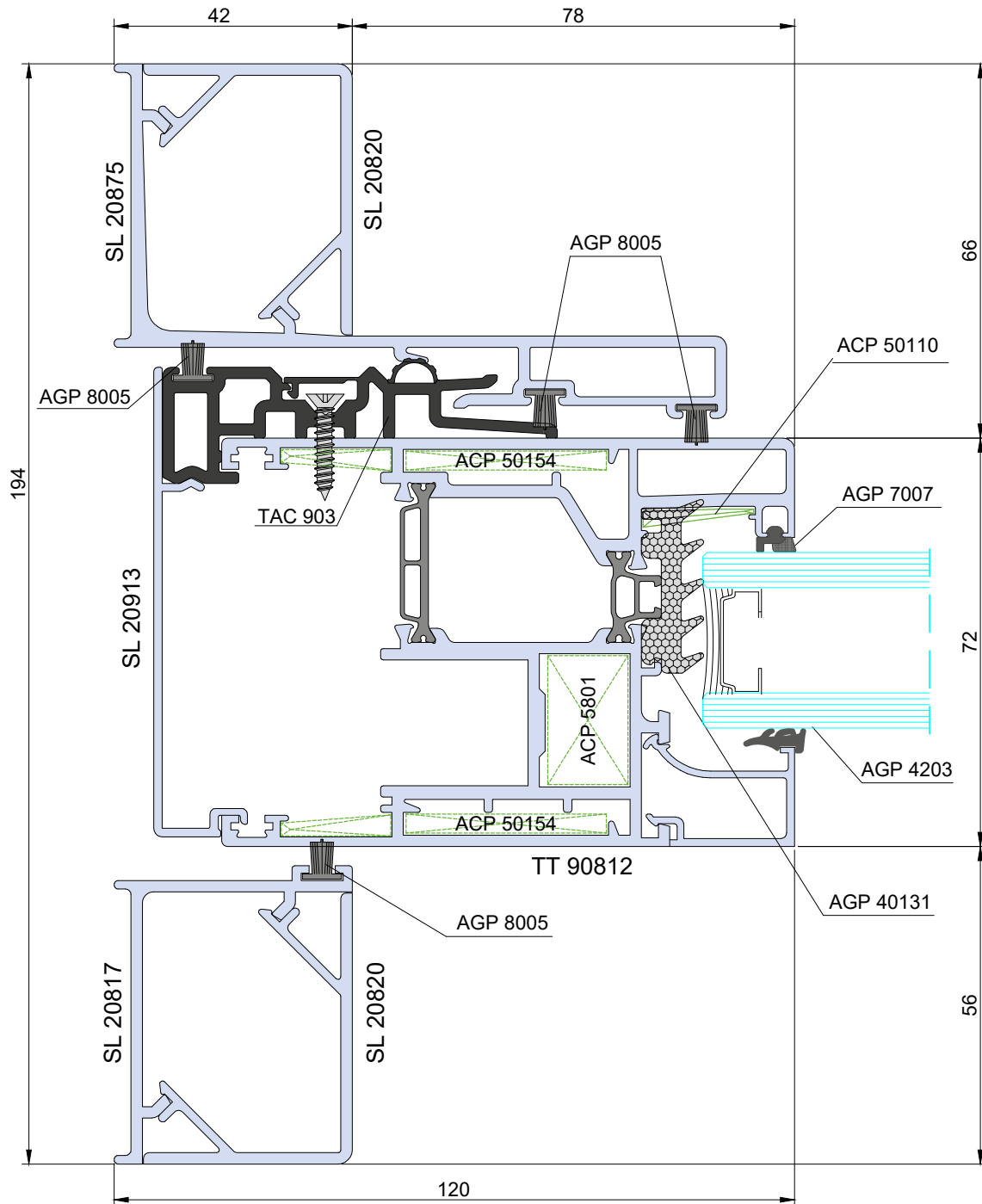



Info prodotto 2106

16.09.2021

it's my window

FERRAMENTA ALZANTE SCORREVOLE

TOP SLIDE 160 PLUS - TOP SLIDE WOOD 214

Di seguito presentiamo i nuovi accessori della ferramenta per le serie Top Slide 160 Plus e Top Slide Wood 214.

Nelle pagine seguenti troverete nel dettaglio:

- Elenco accessori (pag. 2-4);
- Schema di montaggio (pag. 5-7);
- Procedure standard montaggio (pag. 8-12).

EasyDoor
Ecoslim 50 TT
Ecoslim 62 TT
Ecoslim 72 TT
Elite Door 72
Door 62
Door 72
Siro 50
Smart 30
Planet 45
Planet 50 TT
Planet 50 PLUS
Planet 62 TT
Planet 62 PLUS
Planet 72 HT
Planet 72 PLUS
3G
Fullglazing
Matic 50
Matic 50 PLUS
Matic 62 TT
Matic 62 PLUS
Matic 72
Matic 72 PLUS
3G Matic
Nathura 59
Nathura 70
Nathura 82
Nathura 92
Slide 60
Slide 65
Slide 80/106 PLUS
Topslide 160 PLUS
Slidewood 160
Topslidewood 214
Panoramico
Balconi e balaustre



Info prodotto 2106

16.09.2021

alsistem.com

ELENCO ACCESSORI

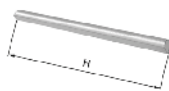
	ACP 90212/1000
	Asta di collegamento carrelli 1000 mm Cfz: 1 pz * <i>Carriage connecting 1000 mm rod Pkg: 1 pc</i>

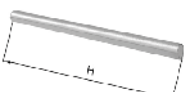
	ACP 90212/1400
	Asta di collegamento carrelli 1400 mm Cfz: 1 pz * <i>Carriage connecting 1400 mm rod Pkg: 1 pc</i>

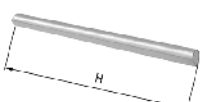
	ACP 90212/1800
	Asta di collegamento carrelli 1800 mm Cfz: 1 pz * <i>Carriage connecting 1800 mm rod Pkg: 1 pc</i>

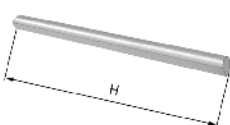
	ACP 90212/2700
	Asta di collegamento carrelli 2700 mm Cfz: 1 pz * <i>Carriage connecting 2700 mm rod Pkg: 1 pc</i>

	ACP 90213/1200
	Asta di comando anta da 800 a 1200 mm Cfz: 1 pz <i>Leaf control rod from 800 to 1200 mm Pkg: 1 pc</i>

	ACP 90213/1800
	Asta di comando anta da 1170 a 1800 mm Cfz: 1 pz <i>Leaf control rod from 1170 to 1800 mm Pkg: 1 pc</i>

	ACP 90213/2150
	Asta di comando anta da 1770 a 2150 mm Cfz: 1 pz <i>Leaf control rod from 1770 to 2150 mm Pkg: 1 pc</i>

	ACP 90213/2400
	Asta di comando anta da 1920 a 2400 mm Cfz: 1 pz <i>Leaf control rod from 1920 to 2400 mm Pkg: 1 pc</i>

	ACP 90213/2750
	Asta di comando anta da 2401 a 2750 mm Cfz: 1 pz <i>Leaf control rod from 2401 to 2750 mm Pkg: 1 pc</i>

	ACP 90214/0
	Prolunga per asta di comando +1000 mm senza punto di chiusura Cfz: 1 pz <i>Extension for command rod +1000 mm Pkg: 1 pc without closing point</i>

* Per dimensioni ante vedi pagina 9



Info prodotto 2106

16.09.2021

ELENCO ACCESSORI

	<p>ACP 90214/1</p> <p>Prolunga per asta di comando +500 mm con punto di chiusura Cfz: 1 pz</p> <p><i>Extension for command rod +500 mm with locking point Pkg: 1 pc</i></p>		<p>ACP 90219</p> <p>Punto di chiusura supplementare Cfz: 1 pz</p> <p><i>Additional locking point Pkg: 1 pc</i></p>
	<p>ACP 90215M</p> <p>Punto chiusura per microventilazione Cfz: 1 pz</p> <p><i>Locking point for microventilation Pkg: 1 pc</i></p>		<p>ACP 90220</p> <p>Spessore per asta di comando Cfz: 1 pz</p> <p><i>Shim for control rod Pkg: 1 pc</i></p>
	<p>ACP 90216</p> <p>Guida asta collegamento carrelli Cfz: 1 pz</p> <p><i>Carriage connecting rod guide Pkg: 1 pc</i></p>		<p>ACP 90221</p> <p>Spessore per punto chiusura Cfz: 1 pz</p> <p><i>Thickness for closing point Pkg: 1 pc</i></p>
	<p>ACP 90218</p> <p>Kit carrelli 330 kg + spessori asta comando a 2 punti chiusura Cfz: 1 kit</p> <p><i>Trolleys kit 330 kg + control rod spacers and 2 locking points Pkg: 1 kit</i></p>		<p>ACP 90222</p> <p>Pistone d'ausilio per sollevamento alzante per ante >200kg abbinare con ACP 90213 Cfz: 1 pz</p> <p><i>Lifting aid piston for >200kg leaf match with ACP 90213 Pkg: 1 pc</i></p>
	<p>ACP 90218 R</p> <p>Kit carrelli registrabili 330 kg da abbinare con 2 pz ACP 90219 e 4 pz ACP 90220 Cfz: 1 kit</p> <p><i>330 kg adjustable trolley kit to be combined with 2 pcs ACP 90219 and 4 pcs ACP 90220 Pkg: 1 kit</i></p>		<p>ACP 90223</p> <p>Kit viti fissaggio asta comando e carrelli alzante Cfz: 1 kit</p> <p><i>Control rod and lifting trolleys fixing screws kit Pkg: 1 kit</i></p>



Info prodotto 2106

16.09.2021

alsistem.com

ELENCO ACCESSORI

	<p>ACP 90224</p> <p>Pistone d'ausilio per sollevamento alzante per ante <200kg abbinare con ACP 90213 Cfz: 1 pz</p> <p><i>Lifting aid piston for <200kg leaf match with ACP 90213 Pkg: 1 pc</i></p>
	<p>ACP 90238</p> <p>Kit carrelli aggiuntivi per 400 kg Cfz: 1 kit</p> <p><i>Additional trolleys kit for 400 kg Pkg: 1 kit</i></p>



Info prodotto 2106

16.09.2021



SCHEMA DI MONTAGGIO

SOLUZIONE CON PERNI

Codifica componenti

DESCRIZIONE	CODICE	Viti utilizzate
Kit Carrelli AS 330 Kg	ACP 90128	A = 4,8x50 mm
1 Carrello anteriore		B = 4,8x32 mm
2 Carrello posteriore		C = 4,8x16 mm
3 Spessore serratura		
4 Perno anta singola / ante coassiali		
- Kit viti di fissaggio		
5 Serratura entrata 37,5 mm	anta da 805 a 1205 mm ACP 90213/1200	
	anta da 1175 a 1805 mm ACP 90213/1800	
	anta da 1775 a 2155 mm ACP 90213/2150	
	anta da 1925 a 2405 mm ACP 90213/2400	
	anta da 2406 a 2755 mm ACP 90213/2750	
6 Maniglione ACP 90201	
7 Spessore regolazione perni ACP 90221	
8 Asta giunzione carrelli	1000 mm ACP 90212/1000	
	1400 mm ACP 90212/1400	
	1800 mm ACP 90212/1800	
	2700 mm ACP 90212/2700	
9 Paracolpi di fine corsa ACP 8043	
10 Guida asta ACP 90216	

Componenti opzionali

DESCRIZIONE	CODICE
+ 101 Perno anta singola / ante coassiali supplementare	ACP 90219
+ 102 Perno con posizione di areazione	ACP 90215 M
+ 103 Prolunga serratura	+1000 mm senza punto di chiusura ACP 90214 / 0
	+500 mm con punto di chiusura ACP 90214 / 1
+ 104 Spessore serratura ACP 90220
+ 105 Kit molla a gas	per ante maggiori di 200 Kg ACP 90222
Kit ammortizzatore	per ante inferiori di 200 Kg ACP 90224
+ 106 Kit carrelli supplementari ACP 90238
+ - Kit carrello AS 330 Kg con carrello posteriore regolabile	ACP 90218 R
+ - Kit viti fissaggio ACP 90223



Info prodotto 2106

16.09.2021

it's my window

alsistem.com

SCHEMA DI MONTAGGIO

FERRAMENTA

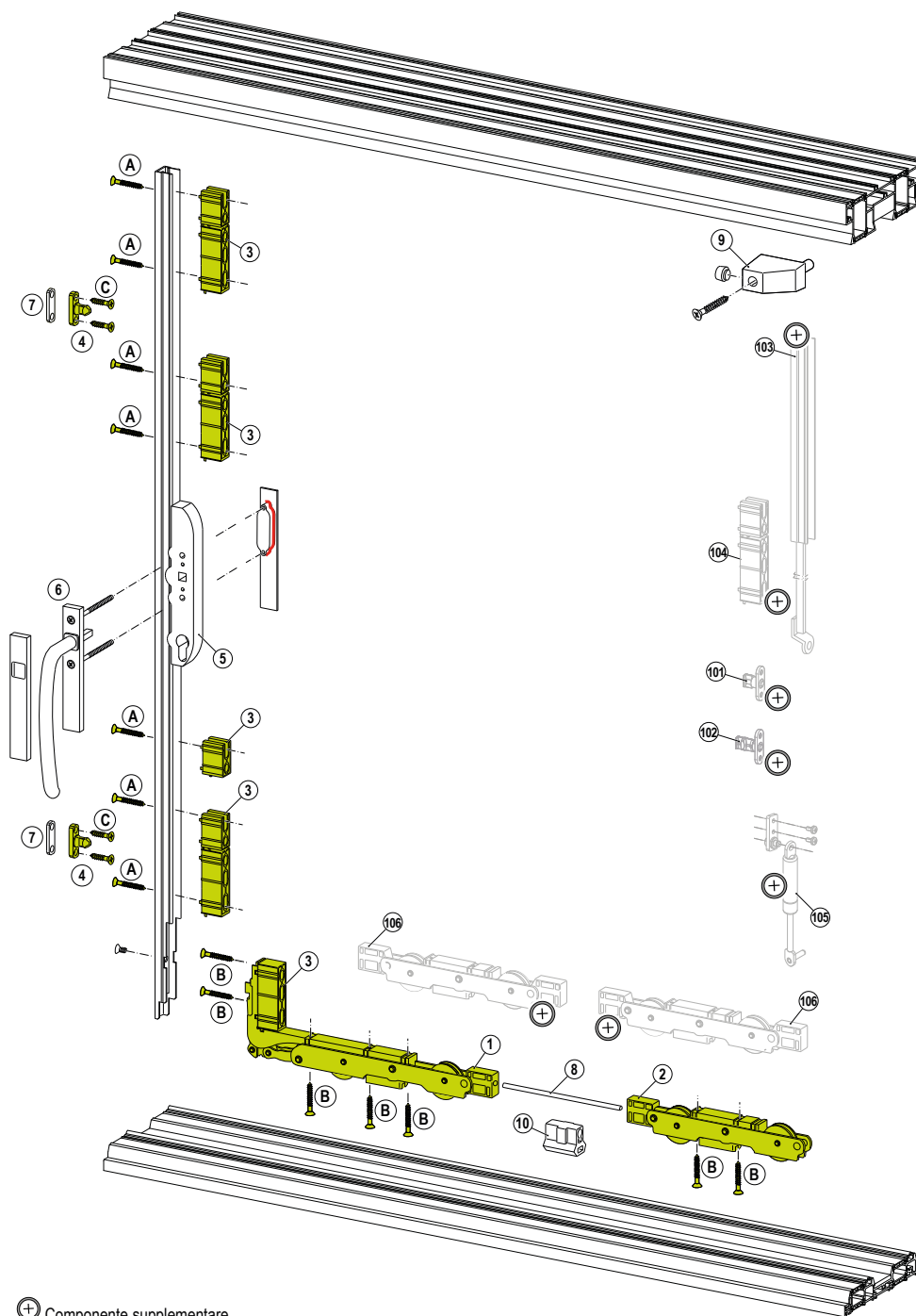

⊕ Componente supplementare



Info prodotto 2106

16.09.2021



SCHEMA DI MONTAGGIO

SEZIONI

Sezione orizzontale

Sezione orizzontale serratura perni

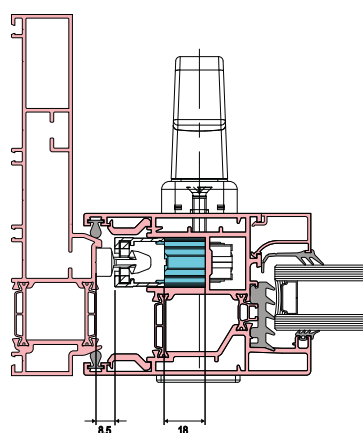

Sezione verticale

Usare guida superiore, tappi di copertura, soglia e tampone centrale superiore forniti con i kit ACP 9033M + ACP 9035M.

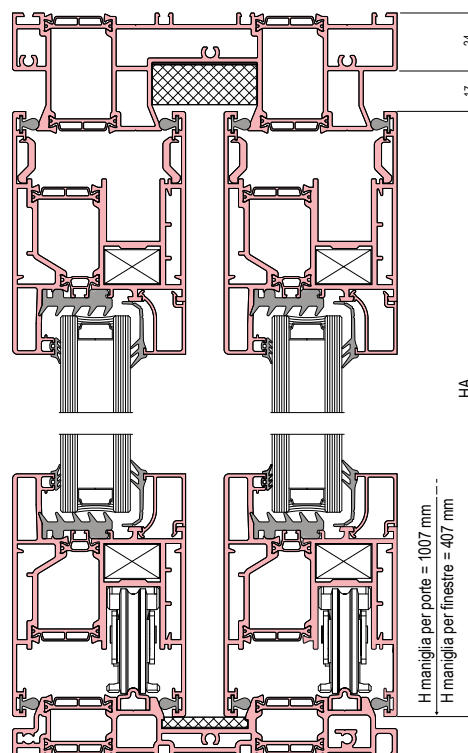

GR	cod	HA min	HA max	HM
1	ACP 90213 / 1200	805	1205	407
2	ACP 90213 / 1800	1175	1805	407
3	ACP 90213 / 2150	1775	2155	1007
4	ACP 90213 / 2400	1925	2405	1007
5	ACP 90213 / 2750	2406	2755	1007



Info prodotto 2106

16.09.2021

alsistem.com

PROCEDURE STANDARD MONTAGGIO

Posizionamento carrelli 330 Kg **ACP 90218**

Formule di taglio asta di giunzione ACP 90212

	1 (pezzi) LAM - 630	2 (pezzi) LAM - 630

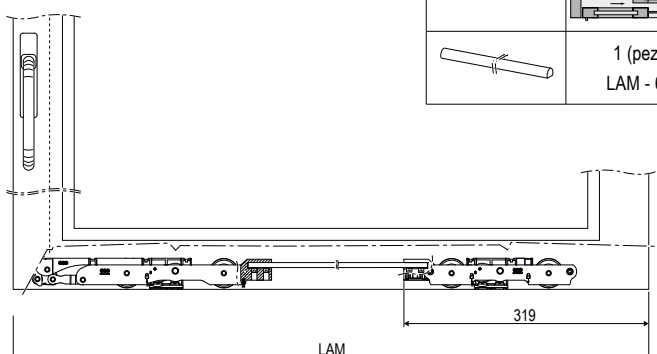

Applicazione carrelli supplementari 440 Kg **ACP 90238**

Formule di taglio asta di giunzione ACP 90212

Con carrelli aggiuntivi	1 (pezzi) LAM-1230	2 (pezzi) LAM-1230
	2 (pezzi) 80 mm	4 (pezzi) 80 mm

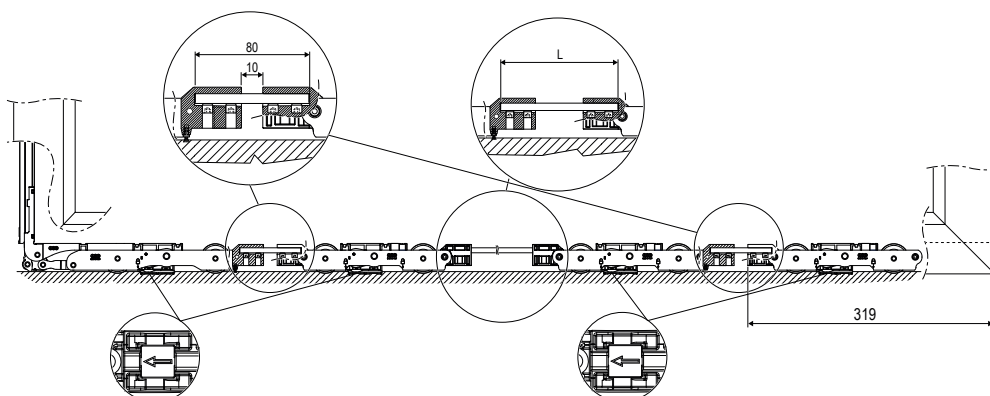

Per collegare i carrelli supplementari, tagliare l'asta di collegamento in tre pezzi, due pezzi di lunghezza 80 mm (vedi figura) ed un terzo pezzo della lunghezza (L) da ricavare seguendo le indicazioni delle formule di taglio.

Applicazione squadrette

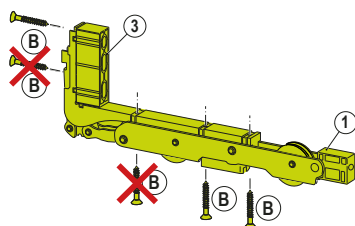

ACP5002



ACP5801M

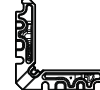

In caso di utilizzo delle squadrette ACP5002 e ACP5801M le viti segnalate andranno in interferenza.



Info prodotto 2106

16.09.2021

it's my window

PROCEDURE STANDARD MONTAGGIO

Dimensioni minime anta con 2 o 4 carrelli.

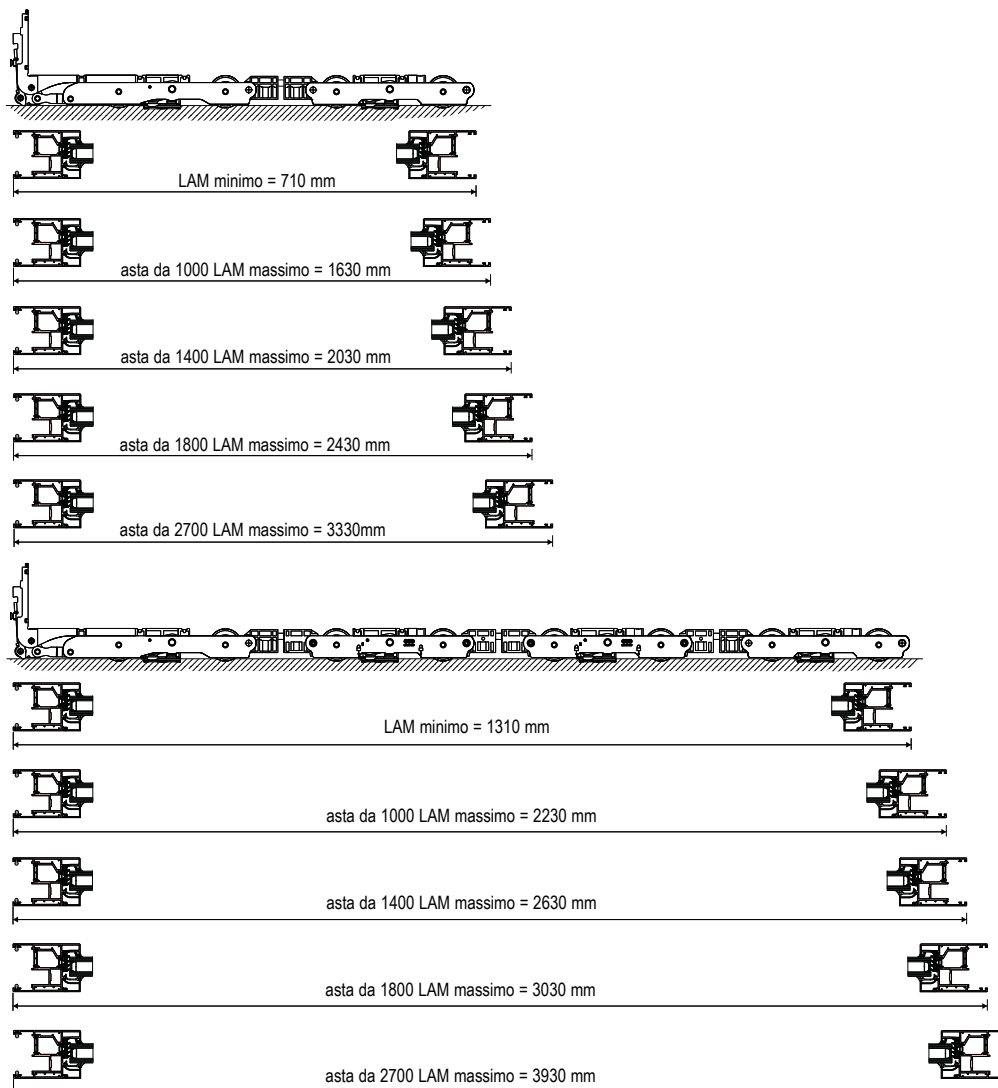

Applicazione carrello regolabile **ACP 90218 R**

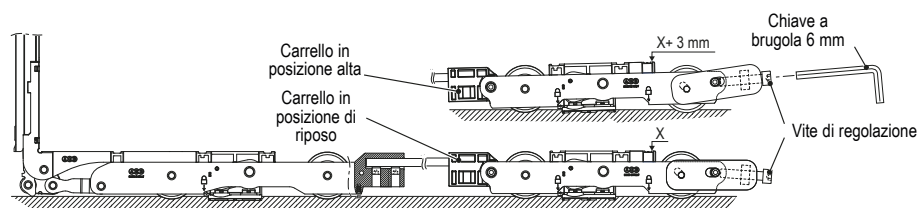



it's my window

Info prodotto 2106

16.09.2021

alsistem.com

PROCEDURE STANDARD MONTAGGIO

Posizionamento spessori serratura

Posizione degli spessori per soluzione a perni

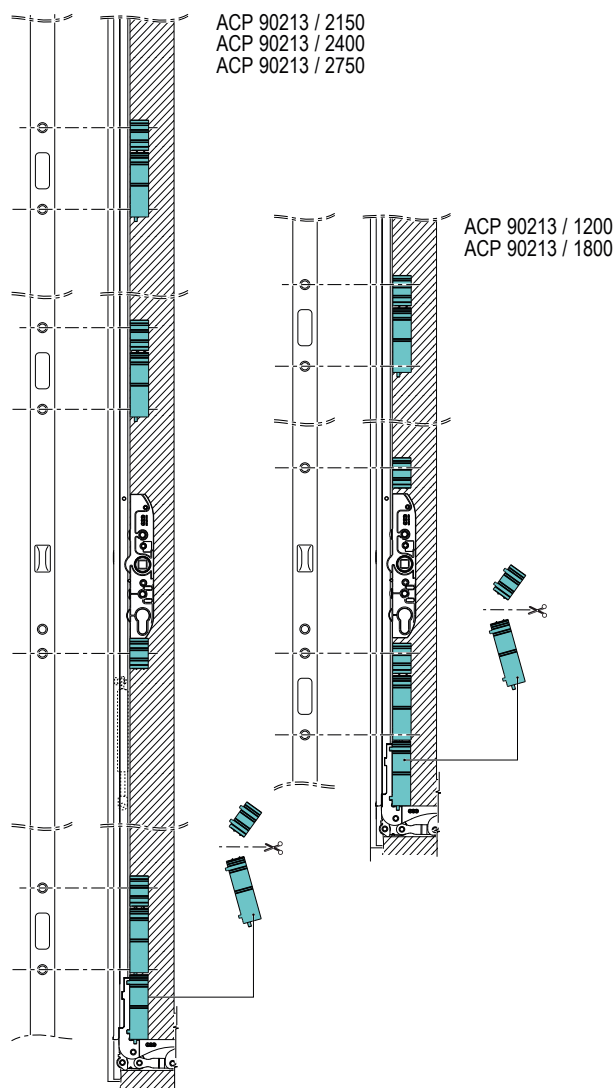

Posizionare gli spessori come indicato in figura.



Info prodotto 2106

16.09.2021

it's my window

PROCEDURE STANDARD MONTAGGIO

Lavorazioni maniglia

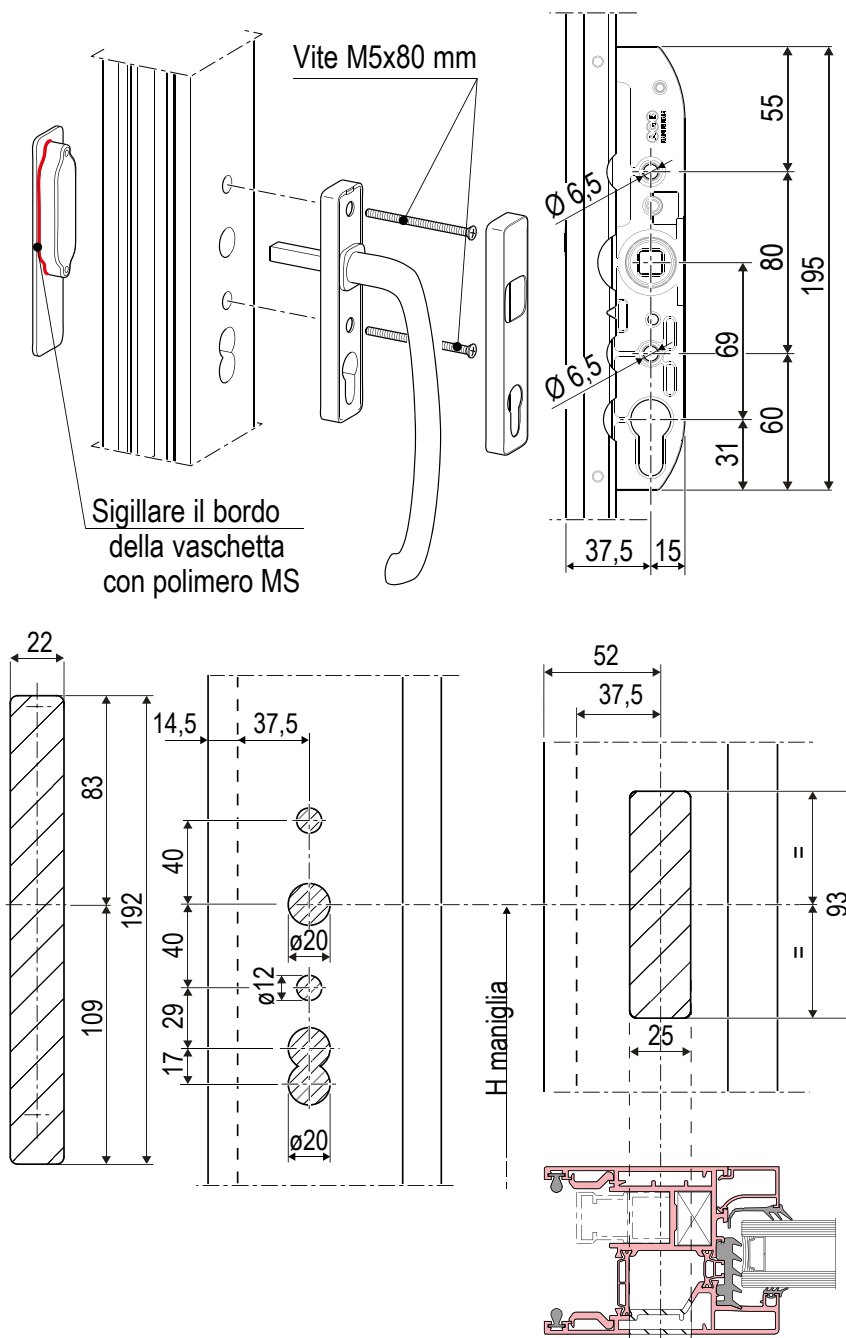



Info prodotto 2106

16.09.2021

it's my window

alsistem.com

PROCEDURE STANDARD MONTAGGIO

Alzante Scorrevole ALSistem

Applicazione con molla a gas

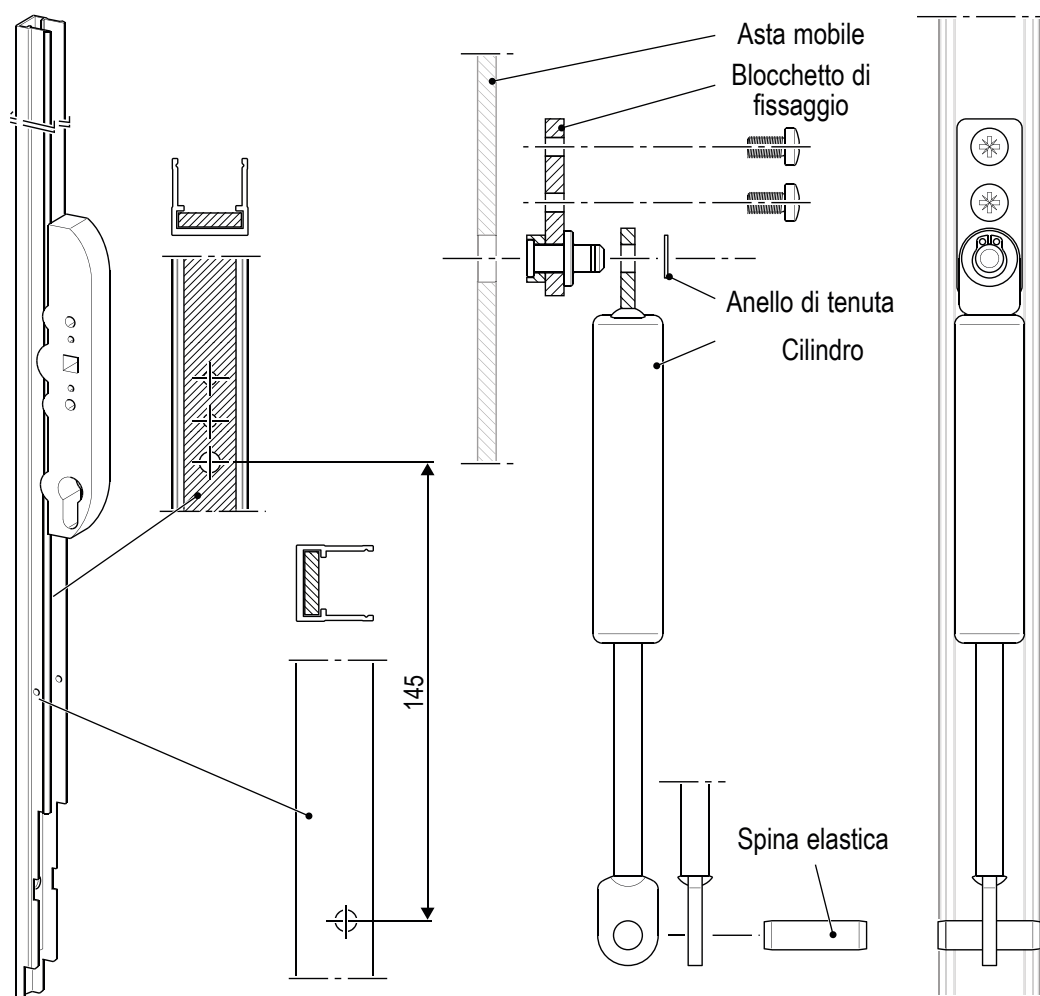

Pistone d'aiusilio per sollevamento ante > 200 Kg	ACP 90222
Pistone d'aiusilio per sollevamento ante < 200 Kg	ACP 90224



Info prodotto 2210

07.10.2022



ACP 90218N

Kit carrelli 330 kg + spessori asta comando a 2 punti chiusura con spessori

Al fine di migliorare il kit già esistente, ad integrazione della Info Prodotto 2106 sulla nuova ferramenta per alzante scorrevole, si è provveduto all'inserimento di due spessori per perni di chiusura.

Pertanto, il nuovo Kit sarà così composto:

- Carrello anteriore;
- Carrello posteriore;
- Spessori per serratura;
- Perni di chiusura;
- Spessori per perni di chiusura;
- Kit viti di fissaggio;

Il Kit avrà un nuovo codice che sarà ACP 90218N.

Di seguito riportiamo schema codifica componenti e composizione ferramenta.

EasyDoor
Ecoslim 50 TT
Ecoslim 62 TT
Ecoslim 72 TT
Elite Door 72
Door 62
Door 72
Sirio 50
Smart 30
Planet 45
Planet 50 TT
Planet 50 PLUS
Planet 62 TT
Planet 62 PLUS
Planet 72 HT
Planet 72 PLUS
3G
Fullglazing
Matic 50
Matic 50 PLUS
Matic 62 TT
Matic 62 PLUS
Matic 72
Matic 72 PLUS
3G Matic
Nathura 59
Nathura 70
Nathura 82
Nathura 92
Slide 60
Slide 65
Slide 80/106 PLUS
Topslide 160 PLUS
Slidewood 160
Topslidewood 214
Panoramico
Balconi e balaustre



Info prodotto 2210

07.10.2022

alsistem.com

SCHEMA DI MONTAGGIO

Codifica componenti

DESCRIZIONE	CODICE	Viti utilizzate
Kit Carrelli AS 330 Kg	ACP 90218N	A = 4,8x50 mm
1 Carrello anteriore		B = 4,8x32 mm
2 Carrello posteriore		C = 4,8x16 mm
3 Spessore serratura		
4 Perno anta singola / ante coassiali		
5 Spessore regolazione perni		
- Kit viti di fissaggio		
6 Serratura entrata 37,5 mm	anta da 805 a 1205 mm ACP 90213/1200	
	anta da 1175 a 1805 mm ACP 90213/1800	
	anta da 1775 a 2155 mm ACP 90213/2150	
	anta da 1925 a 2405 mm ACP 90213/2400	
	anta da 2406 a 2755 mm ACP 90213/2750	
7 Maniglione ACP 90201	
8 Asta giunzione carrelli	1000 mm ACP 90212/1000	
	1400 mm ACP 90212/1400	
	1800 mm ACP 90212/1800	
	2700 mm ACP 90212/2700	
9 Paracolpi di fine corsa ACP 8043	
10 Guida asta ACP 90216	

Componenti opzionali

DESCRIZIONE	CODICE
+ 101 Perno anta singola / ante coassiali supplementare	ACP 90219
+ 102 Perno con posizione di areazione	ACP 90215 M
+ 103 Prolunga serratura	+1000 mm senza punto di chiusura ACP 90214 / 0
	+500 mm con punto di chiusura ACP 90214 / 1
+ 104 Spessore serratura ACP 90220
+ 105 Kit molla a gas	per ante maggiori di 200 Kg ACP 90222
	per ante inferiori di 200 Kg ACP 90224
+ 106 Kit carrelli supplementari ACP 90238
+ - Kit carrello AS 330 Kg con carrello posteriore regolabile	ACP 90218 R
+ - Kit viti fissaggio ACP 90223



Info prodotto 2210

07.10.2022

it's my window

SCHEMA DI MONTAGGIO

Ferramenta

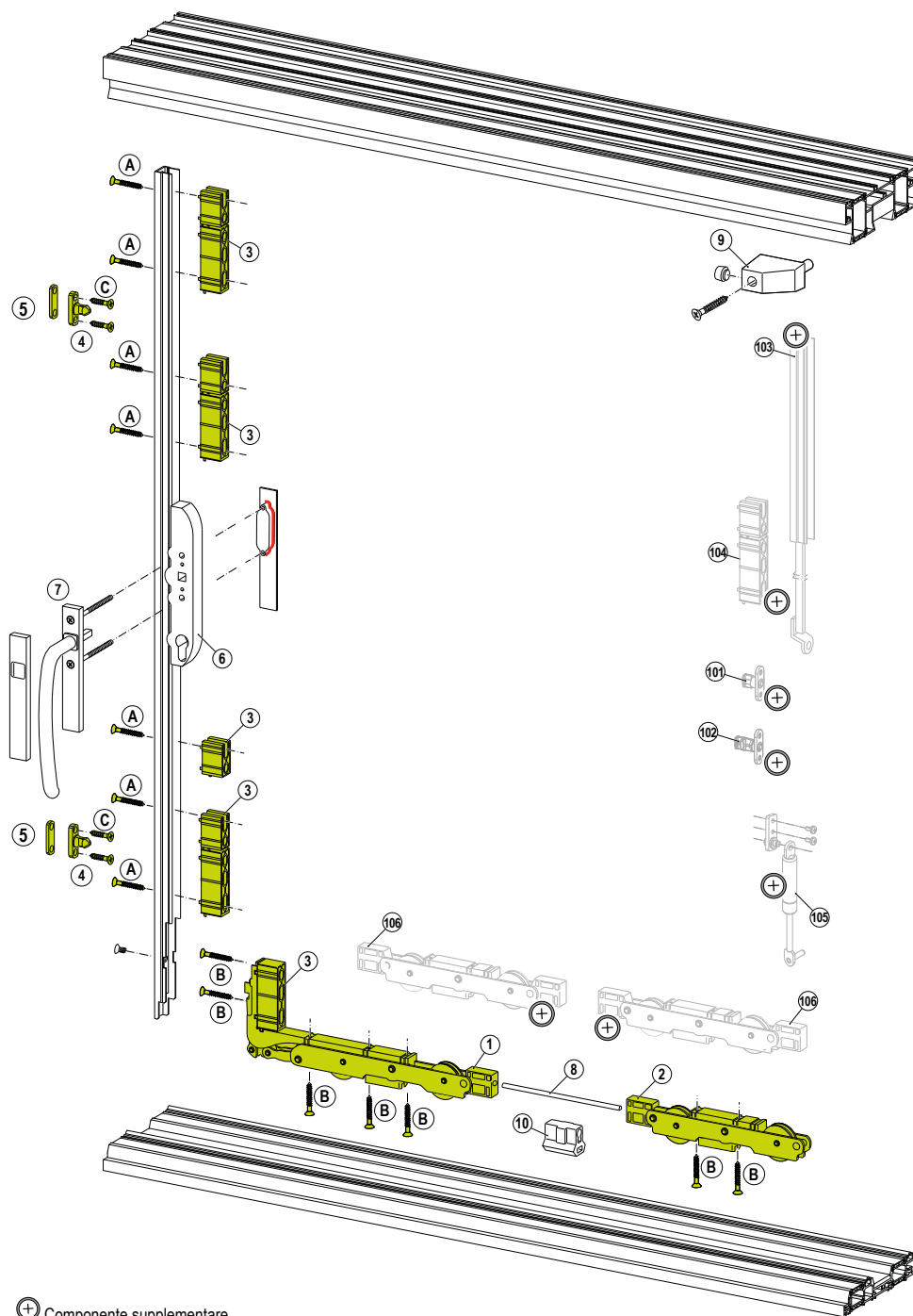

⊕ Componente supplementare



Info prodotto 2401

06.03.2024

alsistem.com

NUOVA GUARNIZIONE VETRAZIONE ESTERNA 4MM COESTRUSA

Vi informiamo che è disponibile la nuova guarnizione di vetratura esterna da 4mm coestrusa AGP 7008.

La guarnizione può essere utilizzata su tutti i sistemi Planet, Ecoslim, 3G, Nathura, Door, Top Slide, Smart 30.

Di seguito trovate:

- Sagoma della guarnizione con codice;
- Nodo esplicativo;

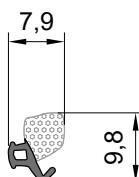

AGP 7008

EasyDoor	
Ecoslim 50 TT	●
Ecoslim 62 TT	●
Ecoslim 62 UP	●
Ecoslim 72 TT	●
Ecoslim 72 UP	●
Elite Door 72	
Door 62	●
Door 72	●
Sirio 50	
Smart 30	●
Planet 45	●
Planet 50 PLUS	●
Planet 62 PLUS	●
Planet 62 UP	●
Planet 72 PLUS	●
Planet 72 UP	●
Matic 50 PLUS	●
Matic 62 PLUS	●
Matic 62 UP	●
Matic 72 PLUS	●
Matic 72 UP	●
3G	●
3G UP	●
Matic 3G	●
Matic 3G UP	●
Nathura 59	●
Nathura 70	●
Nathura 82	●
Nathura 92	●
Slide 60	
Slide 65	
Slide 80/106 PLUS	
Topslide 160 PLUS	●
Slidewood 160	
Topslidewood 214	●
Panoramico	



it's my window

Info prodotto 2401

06.03.2024

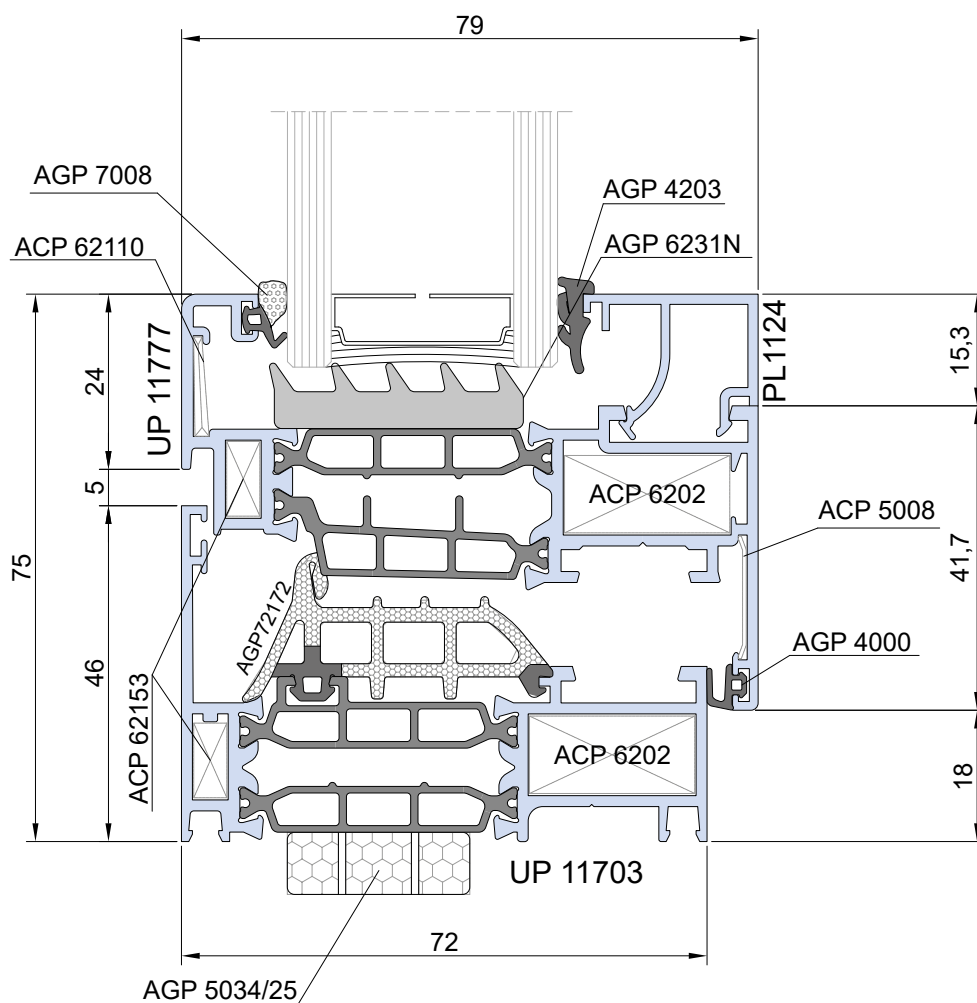



Info prodotto 2402

06.03.2024

it's my window

alsistem.com

ACP 50510 Squadretta di allineamento con colla

Vi informiamo che è disponibile la squadretta di allineamento con colla ACP 50510.

Si tratta di una squadretta che, rispetto all'attuale ACP 50110, è predisposta per l'iniezione della colla ed un serraggio dell'eccentrico maggiorato con chiave Torx.

Di seguito trovate:

- Tabella con codice, descrizione;
- Immagini esplicative;



EasyDoor	
Ecoslim 50 TT	
Ecoslim 62 TT	
Ecoslim 62 UP	
Ecoslim 72 TT	
Ecoslim 72 UP	
Elite Door 72	
Door 62	●
Door 72	●
Sirio 50	
Smart 30	
Planet 45	●
Planet 50 PLUS	●
Planet 62 PLUS	●
Planet 62 UP	●
Planet 72 PLUS	●
Planet 72 UP	●
Matic 50 PLUS	●
Matic 62 PLUS	●
Matic 62 UP	●
Matic 72 PLUS	●
Matic 72 UP	●
3G	
3G UP	
Matic 3G	
Matic 3G UP	
Nathura 59	●
Nathura 70	●
Nathura 82	●
Nathura 92	●
Slide 60	
Slide 65	
Slide 80/106 PLUS	
Topslide 160 PLUS	●
Slidewood 160	
Topslidewood 214	●
Panoramico	

Sistemi a battente alluminio-legno

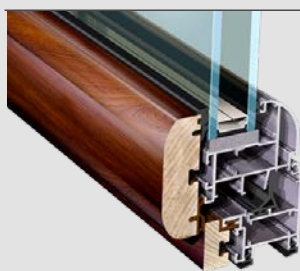

NATHURA 59

Sistema alluminio/legno per serramenti non isolati ad elevata ermeticità

Aluminum/wood system for weatherproof, non-insulated window and door frames



NATHURA 70 - 82 - 92

Sistemi alluminio/legno a taglio termico con ferramenta perimetrale ed elevatissime prestazioni di isolamento termico

Aluminum/wood thermal break systems with perimeter hardware and extra high-performance thermal insulation

Sistemi scorrevoli e alzanti alluminio-legno



SLIDE WOOD 160

Sistema scorrevole alzante a taglio termico alluminio-legno con valori eccellenti di trasmittanza termica, tenuta all'acqua, di portata e sicurezza all'effrazione

Sliding thermal break system, aluminum-wood, with excellent ratings of thermal transmittance, water sealing, load-bearing and anti-intrusion



TOP SLIDE WOOD 214 PLUS 214 UP

Sistema a taglio termico alluminio-legno per serramenti alzanti di elevate dimensioni e peso

Thermal break system, aluminum-wood, for large-size and heavyweight lift-and-slide window and door frames

Sistemi per porte

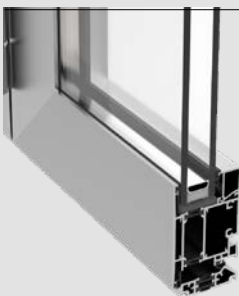

PLANET DOOR 62 DOOR 72

Sistema per la costruzione di porte interne di alto design ad ante o porte scorrevoli di ogni tipologia, finitura estetica e colore

Top-of-the-range internal doors, sash or sliding, all types, finish and color

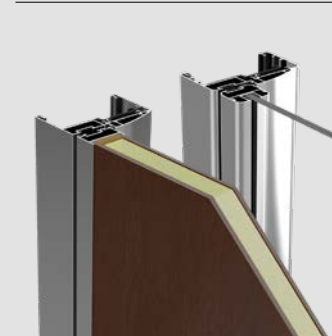

EASY DOOR

Sistema per la costruzione di porte interne di alto design ad ante o porte scorrevoli di ogni tipologia, finitura estetica e colore

Top-of-the-range internal doors, sash or sliding, all types, finish and color



PLANET 45 PORTE COMPLANARI

Sistema termicamente non isolato per porte complanari

Flush door system

Sistemi oscuranti

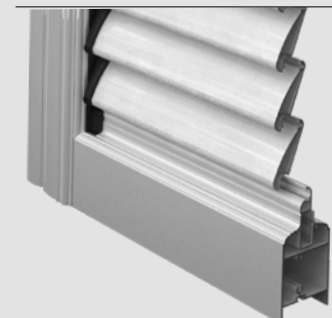

PLANET 45 persiana Venere Pro

Persiane in alluminio con sistema orientabile Venere Pro

European chamber aluminum shutters with double rebated sealing and unique Venere Pro pivot system

Sistemi per facciate



SIRIO 50

Sistema per facciate continue montanti e trasversi

Stick-built curtain wall systems



SIRIO 50 SG

Sistema per facciate continue montanti e trasversi con vetro strutturale

Structural curtain wall with transom/mullion



SIRIO 50 N

Sistema per facciate continue a nastro

Ribbon windows system

Calabria

Principe S.r.l.
Via Carfellà, 14
88040 Settingiano - CZ
T. +39 0961 998281
calabria@alsistem.com

Lazio

Aluroma Metalli S.r.l.
Via dell'Omo, 161
00155 Roma
T. +39 06 2283184
lazio@alsistem.com

Puglia

Sael S.r.l.
Zona PIP- Contrada Pucciarruto snc
72027 San Pietro Vernotico-BR
T. +39 0831 653598
puglia@alsistem.com

Sicilia

Edilsider S.p.a.
Via B. Croce, 26
91011 Alcamo - TP
T. +39 0924 21588
sicilia@alsistem.com

Deposito Sicilia orientale:
Contrada Pirritino Pantano,
Zona Industriale ovest
Piano Tavola
95032 Belpasso - CT
T. +39 095 7132629

Campania, Basilicata

Meral S.p.a.
V. Scavate Case Rosse (Z.I.)
84131 Salerno - SA
T. +39 089 301155
campania@alsistem.com

Lombardia, Triveneto

Alca S.r.l.
Via Copernico, 2
25020 Poncarale - BS
T. +39 030 2681141
lombardia@alsistem.com

Sardegna

Marini S.p.a.
V.le Monastir, Km10.300
09028 Sestu - CA
T. +39 070 22331
sardegna@alsistem.com

Toscana

Ferroedilizia S.r.l.
Via Aurelia Nord, 233
58100 Grosseto - GR
T. +39 0564 456300
toscana@alsistem.com

Marche

CMP S.r.l.
Via Cola, 12
60027 Osimo (AN)
T. +39 071 00171
marche@alsistem.com

Piemonte, Liguria, Valle d'Aosta

Fresia Alluminio S.p.a.
Via Venezia, 35/A
10088 Volpiano - TO
T. +39 011 2250211
piemonte@alsistem.com

Deposito Liguria:

Via C. Festa, 35
16011 Arenzano (GE).
T. +39 019 882783

**P.R.C, Hong kong
Taiwan, Macao**

ALSistem HK
room711,7/f,Ninggu
Commercial Building
no.7940 Humin road,
Minhang district
201102 Shanghai
T. +39 0086 2131332258
F. +39 0086 2131332268

**Sede Legale**

S.S. Varesina,2
22078 Turate - CO

alsistem.com

Engineering

Via Monte Rosa
(angolo via Clerici)
21040 Gerenzano - VA
T. +39 02 9688496
info@alsistem.com



Profilati, accessori e guarnizioni di questo catalogo sono di proprietà di ALSistem, titolare di tutti i diritti di esclusiva.